

CATALOG 2018/19

SENSORS | LIGHTING
VISION | ID | SAFETY

 **di-soric**

WELCOME TO DI-SORIC

ABOUT THE INVENTOR OF THE FORK LIGHT BARRIER: DI-SORIC.

For over 35 years, we have been producing and selling sensors used in industrial automation, primarily in assembly and handling technology, the automotive, electronics and pharmaceutical industries and packaging technology.

Other cornerstones of our product range are image processing and identification systems, high-quality LED lighting and products for work safety. Our subsidiary, di-soric Solutions GmbH & Co. KG, specializes in the business areas of image processing and identification. Our priorities: In addition to high-quality products, di-soric Solutions prioritizes complete solutions, developed for you, which we call "engineered solutions". We are involved in all phases, from consultation and project engineering all the way to integration into your systems.

We combine our resources to help you ensure that your production processes are as precise, free of error and cost-effective as possible, now and in the future.





DI-SORIC FACTS

- **100% OWNER-MANAGED**

- **HEADQUARTERS**

Urbach, Germany

- **TECHNOLOGY AND PRODUCTION CENTER**

Lüdenscheid, Germany

- **REPRESENTATIVES AND
BRANCH OFFICES**

in more than 40 countries

- **CERTIFICATIONS**

IQNet, DQS - ISO 9001:2015, UL, RoHS, GS1

OUR PROMISE TO YOU:

SOLUTIONS.
CLEVER.
PRACTICAL.



SOLUTIONS.

To us, finding solutions means
**providing you with exactly the right solution
for the job.**

- Solution-oriented consultation and implementation
- Product portfolio for numerous application areas
- Engineered solutions for industrial image processing



CLEVER.

To us, being clever means **finding new, smart, unconventional and therefore more effective solutions.**

- Added value for product and application
- Efficient in function and application
- Openness and flexibility for the best solutions















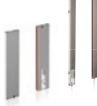

PRACTICAL.

To us, being practical means **being available, taking a straightforward approach and communicating as partners.**

- Solution-oriented consultation and technical expertise
- Straightforward, cooperative and dynamic approach
- Address what is important, and forget about unnecessary factors.

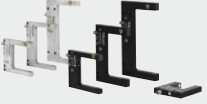
Innovative products for your automation





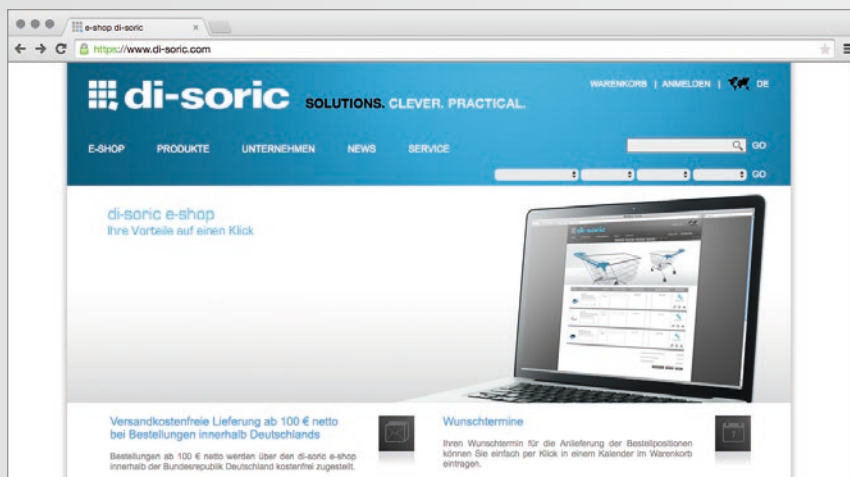











Table of contents		Page			Page
	Company	2		Angled light barriers	36
	Light barriers	8		Frame and ring light barriers	38
	Laser light barriers	16		Plastic fiber-optic sensors	40
	Laser line diffuse sensors	20		Glass fiber-optic sensors	48
	Laser distance sensors	22		Light grids	54
	High-performance light barriers	24		Color sensors	68
	Fork light barriers	26		Ring and wire-break sensors	74
	Laser fork light barriers	34		Tube sensors	80

The product you need—ordering online is easy: **di-soric e-shop**









A clearly structured design combined with intelligent search functions enables you to find the right product quickly. You can use the product finder to select the right products based on technical characteristics.

The product direct selection enables targeted searching for a particular catalog designation or parts of it.

		Page			Page
	Label sensors	82		Flash controllers and lights	148
	Inductive proximity switch	84		Vision sensors	154
	Capacitive proximity switch	118		Vision / ID di-soric Solutions	158
	Cylinder and gripper sensors	122		Vision / ID nVision	160
	Ultrasonic sensors	126		ID systems	162
	Special sensors	134		Lenses	166
	Machine and signal lighting	136		Safety technology	172
	Lighting with integrated power output control	140		Accessories	202

Your advantages—just a click away

-  **Free shipping** within Germany (on orders of 100 euros or more)
-  **Articles with a framework agreement** – Articles can be assigned to existing framework agreements in the shopping cart
-  **Matching accessories** – The accessories that match an article can be called up directly in the shopping cart
-  **Delivery dates by your request** – simply enter them by clicking in your shopping cart calendar
-  **Personalized settings** with order history and management of your user data
-  **SSL encryption** – in conjunction with the highest encryption level your browser supports

Register now at: www.di-soric.com/e-shop

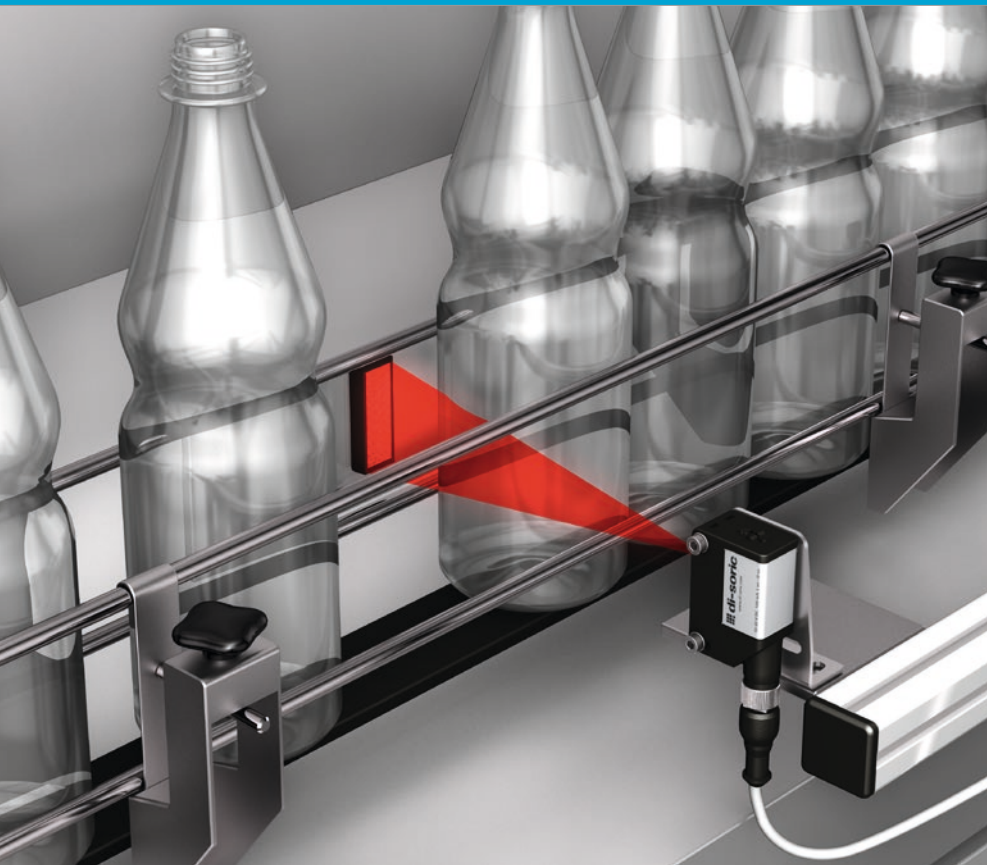

di-soric light barriers are the optimum solution for nearly all automation tasks.

A wide variety of designs and functional principles enable flawless application versatility.

Through-beam sensors

- High resolution
- Operating distances of up to 20 m
- Alignment aid
- High protection type

Retroreflective sensors

- High resolution
- Operating distances of up to 5.7 m
- Potentiometer or teach function
- High protection type

Diffuse sensors



- High resolution
- Scan widths of up to 1.2 m
- Background suppression
- Potentiometer or teach function
- Function reserve / contamination indicator
- High protection type







Technical data (typ.) **+20°C, 24 VDC**





 Service voltage 10 to 30 V DC



 Protection type IP 67

	Scan width / operating distance, setting range (mm)	Housing design Size (mm)	Sensitivity setting by means of	Transmitter (T) / Receiver (R)	Red light, clocked	Infrared light, clocked	Switching output	Ambient temperature (°C)	Switching frequency	Housing material	Cable material/length, Plug connector	Connection cable (optionally available)	
	 Diffuse sensor energetic, cylindrical design											Product description	
	... 10	Ø4.0	-	-	■	pnp, 100 mA NO	0 to +55	250	Stainless steel V2A	2.0m M8	- TK ...	OTV 4.0 V 10 P1K OTV 4.0 V 10 P1K-TSSL	
	... 20	Ø4.0	-	-	■	pnp, 100 mA NO	0 to +55	250	Stainless steel V2A	2.0m M8	- TK ...	OTV 4.0 V 20 P1K OTV 4.0 V 20 P1K-TSSL	
	... 50	Ø4.0	-	-	■	pnp, 100 mA NO	0 to +55	250	Stainless steel V2A	2.0m M8	- TK ...	OTV 4.0 V 50 P1K OTV 4.0 V 50 P1K-TSSL	
	... 10	M5	-	-	■	pnp, 100 mA NO	0 to +55	250	Stainless steel V2A	2.0m M8	- TK ...	OTV 05 V 10 P1K OTV 05 V 10 P1K-TSSL	
	... 20	M5	-	-	■	pnp, 100 mA NO	0 to +55	250	Stainless steel V2A	M8	TK ...	OTV 05 V 20 P1K-TSSL	
	... 50	M5	-	-	■	pnp, 100 mA NO	0 to +55	250	Stainless steel V2A	2.0m M8	- TK ...	OTV 05 V 50 P1K OTV 05 V 50 P1K-TSSL	

	Scan width / operating distance, setting range (mm)	Housing design Size (mm)	Sensitivity setting by means of	Transmitter (T) / Receiver (R)	Red light, clocked	Infrared light, clocked	Switching output	Ambient temperature (°C)	Switching frequency	Housing material	Cable material/length, Plug connector	Connection cable (optionally available)	
	 Diffuse sensor energetic, helical design											Product description	
	400	M18 x 55	Potentiometer	-	■	pnp, 100 mA NO/NC	-25 to +55	1,000	Plastic Metal	M12	VK ... /4	OT 18 FK 400 P3-B4 OT 18 FM 400 P3-B4	
	400	M18 x 55	Potentiometer	-	■	nnp, 100 mA NO/NC	-25 to +55	1,000	Plastic Metal	M12	VK ... /4	OT 18 FK 400 N3-B4 OT 18 FM 400 N3-B4	
	400	M18 x 45	Potentiometer	-	■	pnp, 100 mA NO/NC	-25 to +55	1,000	Plastic Metal	PVC, 2.0m	-	OT 18 FK 400 P3 OT 18 FM 400 P3	
	400	M18 x 45	Potentiometer	-	■	nnp, 100 mA NO/NC	-25 to +55	1,000	Plastic Metal	PVC, 2.0m	-	OT 18 FK 400 N3 OT 18 FM 400 N3	
	800	M18 x 55	Potentiometer	-	■	pnp, 100 mA NO/NC	-25 to +55	1,000	Plastic Metal	M12	VK ... /4	OT 18 FK 800 P3-B4 OT 18 FM 800 P3-B4	
	800	M18 x 55	Potentiometer	-	■	nnp, 100 mA NO/NC	-25 to +55	1,000	Plastic Metal	M12	VK ... /4	OT 18 FK 800 N3-B4 OT 18 FM 800 N3-B4	
	800	M18 x 45	Potentiometer	-	■	pnp, 100 mA NO/NC	-25 to +55	1,000	Plastic Metal	PVC, 2.0m	-	OT 18 FK 800 P3 OT 18 FM 800 P3	
	800	M18 x 45	Potentiometer	-	■	nnp, 100 mA NO/NC	-25 to +55	1,000	Plastic Metal	PVC, 2.0m	-	OT 18 FK 800 N3 OT 18 FM 800 N3	













Light barriers

	Scan width / operating distance, setting range (mm)	Housing design Size (mm)	Sensitivity setting by means of Transmitter (T) / Receiver (R)	Red light, clocked	Infrared light, clocked	Switching output	Ambient temperature (°C)	Switching frequency	Housing material	Cable material/length, Plug connector	Connector cable (optionally available)	Product description
	Retroreflective sensors helical design											
	5,700	M18 x 55	Potentiometer	–	■	pnp, 100 mA NO/NC	-25 to +55	1,000	Plastic Metal	M12	VK... /4	OR 18-1 FK 5700 P3-B4 OR 18-1 FM 5700 P3-B4
	5,700	M18 x 55	Potentiometer	–	■	nnp, 100 mA NO/NC	-25 to +55	1,000	Plastic Metal	M12	VK... /4	OR 18-1 FK 5700 N3-B4 OR 18-1 FM 5700 N3-B4
	5,700	M18 x 45	Potentiometer	–	■	pnp, 100 mA NO/NC	-25 to +55	1,000	Plastic Metal	PVC, 2.0 m	–	OR 18-1 FK 5700 P3 OR 18-1 FM 5700 P3
	5,700	M18 x 45	Potentiometer	–	■	nnp, 100 mA NO/NC	-25 to +55	1,000	Plastic Metal	PVC, 2.0 m	–	OR 18-1 FK 5700 N3 OR 18-1 FM 5700 N3
	5,700	M18 x 45	Potentiometer	–	■	nnp, 100 mA NO/NC	-25 to +55	1,000	Plastic Metal	PVC, 2.0 m	–	OR 18-1 FK 5700 N3 OR 18-1 FM 5700 N3
	Through-beam sensors helical design											
	10,000	M18 x 55	Potentiometer	–	■	pnp, 100 mA NO/NC	-25 to +55	333	Plastic Metal	M12	VK... /4	OES 18 FK 10000 P3-B4 OES 18 FM 10000 P3-B4
	10,000	M18 x 55	Potentiometer	–	■	nnp, 100 mA NO/NC	-25 to +55	333	Plastic Metal	M12	VK... /4	OES 18 FK 10000 N3-B4 OES 18 FM 10000 N3-B4
	10,000	M18 x 45	Potentiometer	–	■	pnp, 100 mA NO/NC	-25 to +55	333	Plastic Metal	PVC, 2.0 m	–	OES 18 FK 10000 P3 OES 18 FM 10000 P3
	10,000	M18 x 45	Potentiometer	–	■	nnp, 100 mA NO/NC	-25 to +55	333	Plastic Metal	PVC, 2.0 m	–	OES 18 FK 10000 N3 OES 18 FM 10000 N3
	10,000	M18 x 45	Potentiometer	–	■	nnp, 100 mA NO/NC	-25 to +55	333	Plastic Metal	PVC, 2.0 m	–	OES 18 FK 10000 N3 OES 18 FM 10000 N3
	Diffuse sensor angled optics energetic, helical design											
	320	M18 x 68	Potentiometer	–	■	pnp, 100 mA NO/NC	-25 to +55	1,000	Plastic Metal	M12	VK... /4	OT 18 FKR 320 P3-B4 OT 18 FMR 320 P3-B4
	320	M18 x 68	Potentiometer	–	■	nnp, 100 mA NO/NC	-25 to +55	1,000	Plastic Metal	M12	VK... /4	OT 18 FKR 320 N3-B4 OT 18 FMR 320 N3-B4
	320	M18 x 58	Potentiometer	–	■	pnp, 100 mA NO/NC	-25 to +55	1,000	Plastic Metal	PVC, 2.0 m	–	OT 18 FKR 320 P3 OT 18 FMR 320 P3
	320	M18 x 58	Potentiometer	–	■	nnp, 100 mA NO/NC	-25 to +55	1,000	Plastic Metal	PVC, 2.0 m	–	OT 18 FKR 320 N3 OT 18 FMR 320 N3
	600	M18 x 68	Potentiometer	–	■	pnp, 100 mA NO/NC	-25 to +55	1,000	Plastic Metal	M12	VK... /4	OT 18 FKR 600 P3-B4 OT 18 FMR 600 P3-B4
	600	M18 x 68	Potentiometer	–	■	nnp, 100 mA NO/NC	-25 to +55	1,000	Plastic Metal	M12	VK... /4	OT 18 FKR 600 N3-B4 OT 18 FMR 600 N3-B4
	600	M18 x 58	Potentiometer	–	■	pnp, 100 mA NO/NC	-25 to +55	1,000	Plastic Metal	PVC, 2.0 m	–	OT 18 FKR 600 P3 OT 18 FMR 600 P3
	600	M18 x 58	Potentiometer	–	■	nnp, 100 mA NO/NC	-25 to +55	1,000	Plastic Metal	PVC, 2.0 m	–	OT 18 FKR 600 N3 OT 18 FMR 600 N3
	600	M18 x 58	Potentiometer	–	■	nnp, 100 mA NO/NC	-25 to +55	1,000	Plastic Metal	PVC, 2.0 m	–	OT 18 FKR 600 N3 OT 18 FMR 600 N3





	Scan width / operating distance, setting range (mm)	Housing design Size (mm)	Sensitivity setting by means of	Transmitter (T) / Receiver (R)	Red light, clocked	Infrared light, clocked	Switching output	Ambient temperature (°C)	Switching frequency	Housing material	Cable material/length, Plug connector	Connection cable (optionally available)	
	Retroreflective sensors angled optics, helical design												Product description
	3,600	M18 x 68	Potentiometer	-	■		pnp, 100 mA NO/NC	-25 to +55	1,000	Plastic Metal	M12	VK... /4	OR 18-1 FKR 3600 P3-B4 OR 18-1 FMR 3600 P3-B4
	3,600	M18 x 68	Potentiometer	-	■		nnp, 100 mA NO/NC	-25 to +55	1,000	Plastic Metal	M12	VK... /4	OR 18-1 FKR 3600 N3-B4 OR 18-1 FMR 3600 N3-B4
	3,600	M18 x 58	Potentiometer	-	■		pnp, 100 mA NO/NC	-25 to +55	1,000	Plastic Metal	PVC, 2.0m	-	OR 18-1 FKR 3600 P3 OR 18-1 FMR 3600 P3
	3,600	M18 x 58	Potentiometer	-	■		nnp, 100 mA NO/NC	-25 to +55	1,000	Plastic Metal	PVC, 2.0m	-	OR 18-1 FKR 3600 N3 OR 18-1 FMR 3600 N3
		Through-beam sensors angled optics, helical design											
8,000		M18 x 68	Potentiometer	-		■	pnp, 100 mA NO/NC	-25 to +55	1,000	Plastic Metal	M12	VK... /4	OES 18 FKR 8000 P3-B4 OES 18 FMR 8000 P3-B4
8,000		M18 x 68	Potentiometer	-		■	nnp, 100 mA NO/NC	-25 to +55	1,000	Plastic Metal	M12	VK... /4	OES 18 FKR 8000 N3-B4 OES 18 FMR 8000 N3-B4
8,000		M18 x 58	Potentiometer	-		■	pnp, 100 mA NO/NC	-25 to +55	1,000	Plastic Metal	PVC, 2.0m	-	OES 18 FKR 8000 P3 OES 18 FMR 8000 P3
8,000		M18 x 58	Potentiometer	-		■	nnp, 100 mA NO/NC	-25 to +55	1,000	Plastic Metal	PVC, 2.0m	-	OES 18 FKR 8000 N3 OES 18 FMR 8000 N3
		Diffuse sensors with background suppression, helical design											
	30 to 130	M18 x 80	Potentiometer	-	■		pnp, 100 mA NO/NC nnp, 100 mA NO/NC	-25 to +70	1,000	Metal	M12	VK... /4	OH 18-1 M 130 P4-B4 OH 18-1 M 130 N4-B4
	Retroreflective sensors helical design												
	3,000	M18 x 83	Potentiometer	-	■		pnp, 100 mA NO/NC nnp, 100 mA NO/NC	-25 to +70	250	Metal	M12	VK... /4	OR 18-1 M 3000 P4-B4 OR 18-1 M 3000 N4-B4







Light barriers

	Scan width / operating distance, setting range (mm)	Housing design Size (mm)	Sensitivity setting by means of	Transmitter (T) / Receiver (R)	Red light, clocked	Infrared light, clocked	Switching output	Ambient temperature (°C)	Switching frequency	Housing material	Cable material/length, Plug connector	Connection cable (optionally available)		
	Diffuse sensor energetic, rectangular design												Product description	
		6 to 14	22 x 10 x 8	Potentiometer	-	■		pnp, 50 mA NO	-25 to +55	1,000	Plastic	PVC, 2.0 m	-	OTV 22 K 14 P1K
								pnp, 50 mA NC						OTV 22 K 14 P2K
		90 to 115	22 x 10 x 8	Potentiometer	-	■		pnp, 50 mA NO	-25 to +55	1,000	Plastic	PVC, 2.0 m	-	OTV 22 K 115 P1K
								pnp, 50 mA NC						OTV 22 K 115 P2K
		15 to 160	22 x 10 x 8	Potentiometer	-	■		pnp, 50 mA NO	-25 to +55	1,000	Plastic	PVC, 2.0 m	-	OTV 22 K 160 P1K
								pnp, 50 mA NC						OTV 22 K 160 P2K
		Retroreflective sensors rectangular design												
			30 to 200	22 x 10 x 8	Potentiometer	-	■		pnp, 50 mA NO	-25 to +55	1,000	Plastic	PVC, 2.0 m	-
pnp, 50 mA NC									ORV 22 K 200 P2K					
	Through-beam sensors rectangular design													
		0 to 2,000	19 x 10 x 8	Potentiometer	T/R	■		pnp, 50 mA NO/NC	-25 to +55	1,000	Plastic	PVC, 2.0 m	-	OESV 19 K 2000 P3K
	Diffuse sensor energetic, rectangular design												Product description	
		10 to 100	31 x 21 x 13	Potentiometer	-	■		pnp, 100 mA NO/NC	-25 to +70	1,000	Plastic	M8	TK ... /4	OT 31 K 100 P3-T4
												0.2 m / M8	TK ...	OT 31 K 100 P3-K-T3
												2.0 m	-	OT 31 K 100 P3-3
		10 to 100	31 x 21 x 13	Potentiometer	-	■		nnp, 100 mA NO/NC	-25 to +70	1,000	Plastic	M8	TK ... /4	OT 31 K 100 N3-T4
												0.2 m / M8	TK ...	OT 31 K 100 N3-K-T3
												2.0 m	-	OT 31 K 100 N3-3
		0 to 400	31 x 21 x 13	Potentiometer	-	■		pnp, 100 mA NO/NC	-25 to +70	2,000	Plastic	M8	TK ... /4	OT 31 K 400 P3-T4
												0.2 m / M8	TK ...	OT 31 K 400 P3-K-T3
												2.0 m	-	OT 31 K 400 P3-3
		0 to 400	31 x 21 x 13	Potentiometer	-	■		nnp, 100 mA NO/NC	-25 to +70	2,000	Plastic	M8	TK ... /4	OT 31 K 400 N3-T4
												0.2 m / M8	TK ...	OT 31 K 400 N3-K-T3
												2.0 m	-	OT 31 K 400 N3-3
		0 to 1,000	31 x 21 x 13	Potentiometer	-	■		pnp, 100 mA NO/NC	-25 to +70	1,000	Plastic	M8	TK ... /4	OT 31 K 1000 P3-T4
												0.2 m / M8	TK ...	OT 31 K 1000 P3-K-T3
												2.0 m	-	OT 31 K 1000 P3-3
		0 to 1,000	31 x 21 x 13	Potentiometer	-	■		nnp, 100 mA NO/NC	-25 to +70	1,000	Plastic	M8	TK ... /4	OT 31 K 1000 N3-T4
												0.2 m / M8	TK ...	OT 31 K 1000 N3-K-T3
2.0 m												-	OT 31 K 1000 N3-3	

	Scan width / operating distance, setting range (mm)	Housing design Size (mm)	Sensitivity setting by means of	Transmitter (T) / Receiver (R)	Red light, clocked	Infrared light, clocked	Switching output	Ambient temperature (°C)	Switching frequency	Housing material	Cable material/length, Plug connector	Connection cable (optionally available)	
	 Diffuse sensors with background suppression, rectangular design											Product description	
	30 to 200	31 x 21 x 13	Potentiometer	-	■		pnp, 100 mA NO/NC	-25 to +70	1,000	Plastic	M8 0.2m/M8 2.0m	TK ... /4 TK ... -	OH 31 K 200 P3-T4 OH 31 K 200 P3-K-T3 OH 31 K 200 P3-3
	30 to 200	31 x 21 x 13	Potentiometer	-	■		nnp, 100 mA NO/NC	-25 to +70	1,000	Plastic	M8 0.2m/M8 2.0m	TK ... /4 TK ... -	OH 31 K 200 N3-T4 OH 31 K 200 N3-K-T3 OH 31 K 200 N3-3
	30 to 400	31 x 21 x 13	Potentiometer	-		■	pnp, 100 mA NO/NC	-25 to +70	1,000	Plastic	M8 0.2m/M8 2.0m	TK ... /4 TK ... -	OH 30 K 400 P3-T4 OH 30 K 400 P3-K-T3 OH 30 K 400 P3-3
	30 to 400	31 x 21 x 13	Potentiometer	-		■	nnp, 100 mA NO/NC	-25 to +70	1,000	Plastic	M8 0.2m/M8 2.0m	TK ... /4 TK ... -	OH 30 K 400 N3-T4 OH 30 K 400 N3-K-T3 OH 30 K 400 N3-3
	 Retroreflective sensors rectangular design												
	50 to 1,500	31 x 21 x 13	Potentiometer	-	■		pnp, 100 mA NO/NC	-25 to +70	2,000	Plastic	M8 0.2m/M8 2.0m	TK ... /4 TK ... -	OR 31 K 1500 P3-T4 OR 31 K 1500 P3-K-T3 OR 31 K 1500 P3-3
	50 to 1,500	31 x 21 x 13	Potentiometer	-	■		nnp, 100 mA NO/NC	-25 to +70	2,000	Plastic	M8 0.2m/M8 2.0m	TK ... /4 TK ... -	OR 31 K 1500 N3-T4 OR 31 K 1500 N3-K-T3 OR 31 K 1500 N3-3
	400 to 4,000	31 x 21 x 13	Potentiometer	-	■		pnp, 100 mA NO/NC	-25 to +70	2,000	Plastic	M8 0.2m/M8 2.0m	TK ... /4 TK ... -	OR 31 K 4000 P3-T4 OR 31 K 4000 P3-K-T3 OR 31 K 4000 P3-3
	400 to 4,000	31 x 21 x 13	Potentiometer	-	■		nnp, 100 mA NO/NC	-25 to +70	2,000	Plastic	M8 0.2m/M8 2.0m	TK ... /4 TK ... -	OR 31 K 4000 N3-T4 OR 31 K 4000 N3-K-T3 OR 31 K 4000 N3-3
	20 to 5,000	31 x 21 x 13	Potentiometer	-	■		pnp, 100 mA NO/NC	-25 to +70	2,000	Plastic	M8 0.2m/M8 2.0m	TK ... /4 TK ... -	OR 31 K 5000 P3-T4 OR 31 K 5000 P3-K-T3 OR 31 K 5000 P3-3
	20 to 5,000	31 x 21 x 13	Potentiometer	-	■		nnp, 100 mA NO/NC	-25 to +70	2,000	Plastic	M8 0.2m/M8 2m	TK ... /4 TK ... -	OR 31 K 5000 N3-T4 OR 31 K 5000 N3-K-T3 OR 31 K 5000 N3-3
	 Through-beam sensors rectangular design												
	0 to 20,000	31 x 21 x 13	Potentiometer	-	■		pnp, 100 mA NO/NC	-25 to +70	2,000	Plastic	M8 0.2m/M8 2.0m	TK ... /4 TK ... -	OES 31 K 20000 P3-T4 OES 31 K 20000 P3-K-T3 OES 31 K 20000 P3-3
	0 to 20,000	31 x 21 x 13	Potentiometer	-	■		nnp, 100 mA NO/NC	-25 to +70	2,000	Plastic	M8 0.2m/M8 2.0m	TK ... /4 TK ... -	OES 31 K 20000 N3-T4 OES 31 K 20000 N3-K-T3 OES 31 K 20000 N3-3

Light barriers

	Scan width / operating distance, setting range (mm)	Housing design Size (mm)	Sensitivity setting by means of	Transmitter (T) / Receiver (R)	Red light, clocked	Infrared light, clocked	Switching output	Ambient temperature (°C)	Switching frequency	Housing material	Cable material/length, Plug connector	Connector cable (optionally available)	
	 Diffuse sensor energetic, rectangular design											Product description	
	10 to 600	38 x 27 x 15	Potentiometer	-	■		pnp, 100 mA NO pnp, 100 mA NC	-25 to +60	500	Plastic	M8	TK ...	OT 6-41 K 0.6 P1-T3 OT 6-41 K 0.6 P2-T3
	100 to 1,000	41 x 31.5 x 16	Teach Teach Remote teach	-	■		Push-pull, 200 mA NO/NC Push-pull, 200 mA NO/NC	-25 to +60	1,000	Plastic	M8	TK ... TK ... /4	OTT 41 M 1 G3-T3 OTT 41 M 1 FG3-T4
	 Retroreflective sensors rectangular design												
	400 to 4,000	38 x 27 x 15	Potentiometer	-	■		pnp, 100 mA NC pnp, 100 mA NO	-25 to +60	500	Plastic	M8	TK ...	OR 6-41 K 4 P1-T3 OR 6-41 K 4 P2-T3

	Scan width / operating distance, setting range (mm)	Housing design Size (mm)	Sensitivity setting by means of	Transmitter (T) / Receiver (R)	Red light, clocked	Infrared light, clocked	Switching output	Ambient temperature (°C)	Switching frequency	Housing material	Cable material/length, Plug connector	Connection cable (optionally available)	
	 Diffuse sensor energetic												Product description
	15 to 150	50 x 40 x 15	Potentiometer	-	■		pnp, 200 mA NO/NC	-10 to +60	1,000	Metal	M12	VK ...	OTV 51 M 150 P3K-IBS
	100 to 500												OTV 51 M 500 P3K-IBS
	100 to 600	50 x 40 x 15	Potentiometer	-		■	pnp, 200 mA NO/NC	-10 to +60	1,000	Metal	M12	VK ...	OTV 50 M 600 P3K-IBS
	50 to 1,200												OTV 50 M 1200 P3K-IBS
	 Retroreflective sensors rectangular design												
	40 to 2,000	50 x 40 x 15	Potentiometer	-	■		pnp, 200 mA NO/NC	-10 to +60	1,000	Metal	M12	VK ...	ORV 51 M 2000 P3K-IBS
	300 to 5,000	50 x 40 x 15	Potentiometer	-	■		pnp, 200 mA NO/NC	-10 to +60	1,000	Metal	M12	VK ...	ORV 51 M 5000 P3K-IBS
	 Through-beam sensors rectangular design												
	0 to 10,000	50 x 40 x 15	Potentiometer	T	■		-	-25 to +60		Metal	M12	VK ...	OSV 51 M 10000-IBS
			E			pnp, 200 mA NO/NC		100/200					OEV 51 M 10000-P3K-IBS



Laser light barriers and diffuse sensors are used for the precise detection of small parts in all areas of automation. These devices are lightning-fast, non-contact, wear-free and extremely precise, counting small parts, determining their position and completeness exactly, and providing trigger signals for camera systems and system controls.

Laser light barriers

- Collimated red-light laser
- Various designs
- Resolution down to 0.2 mm
- High switching frequency

Laser line retroreflective sensors

- Red-light laser, clocked
- Fan-shaped laser beam with auto-collimation principle
- Detection of small parts within the active zone



Laser diffuse sensors with foreground and background suppression



- Red-light laser, with small laser spot
- Large detection range
- Automatic adjustment of transmitting power
- Remote teach option and key lock function
- Push-pull output pnp + npn
- Light/dark switching switchable

Laser diffuse sensors with background suppression



- Red-light laser
- Optical or electronic background suppression
- Vibration-proof multiturn adjustment for finest adjustment
- High resolution, switching accuracy, switching frequency
- Automatic adjustment of transmitting power



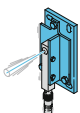

Technical data (typ.)	+20°C, 24 VDC
Emitted light	Red-light laser
Service voltage	10 to 35 V DC
	10.8 to 26.4 VDC (LLT 21 ... / LES 21 ...)
	18 to 30 V DC (LVHT 51 ...)
Protection type	IP 67

	Scan width / operating distance, setting range (mm)	Housing design Size (mm)	Sensitivity setting by means of	Transmitter (T) / Receiver (R)	Switching output	Switching frequency (Hz)	Laser class	Ambient temperature (°C)	Housing material	Cable material/length, Plug connector	Connection cable (optionally available)	Product description
	 Laser through-beam sensors helical or rectangular design											
	0 to 2,000	M8 x 70	-	T	-	2,000	1	0 to +50	Stainless steel	M8	TK ...	OLS 08 V 2000-TSSL
				E	pnp, 200 mA NO							OLE 08 V 2000 P2K-TSSL
	0 to 500	10 x 10 x 60	-	T	-	2,000	1	0 to +50	Metal	M8	TK ...	OLSQ 10 M 500-TSSL
				E	pnp, 200 mA NC							OLEQ 10 M 500 P1K-TSSL
				E	pnp, 200 mA NO							OLEQ 10 M 500 P2K-TSSL
0 to 2,000	10 x 10 x 60	-	T	-	2,000	1	0 to +50	Metal	M8	TK ...	OLSQ 10 M 2000-TSSL	
			E	pnp, 200 mA NC							OLEQ 10 M 2000 P1K-TSSL	
			E	pnp, 200 mA NO							OLEQ 10 M 2000 P2K-TSSL	









	Swash plate for OLE/OLS Q 10 ...	
	For easy alignment of laser light barriers in the series OLS Q 10 ...	
		TP1-Q90

	Scan width / operating distance, setting range (mm)	Housing design Size (mm)	Sensitivity setting by means of	Transmitter (T) / Receiver (R)	Switching output	Switching frequency (Hz)	Laser class	Ambient temperature (°C)	Housing material	Cable material/length, Plug connector	Connection cable (optionally available)	Product description
	 Laser diffuse sensors rectangular design											
	20 to 50	22 x 13 x 8.5	Potentiometer	-	pnp, 50 mA NO/NC	1,000	1	-10 to +55	Plastic	2.0 m	-	LT 21 K 50 P3
										M8	TK ... /4	LT 21 K 50 P3-K-T4
45 to 300	22 x 13 x 8.5	Potentiometer	-	pnp, 50 mA NO/NC	1,000	1	-10 to +55	Plastic	2.0 m	-	LT 21 K 300 P3	
									M8	TK ... /4		LT 21 K 300 P3-K-T4

	 Laser retroreflective sensors rectangular design											
	0 to 4,000	22 x 13 x 8.5	Potentiometer	-	pnp, 50 mA NO/NC	1,000	1	-10 to +55	Plastic	2.0 m	-	LT 21 K 4000 P3
									M8	TK ... /4		LT 21 K 4000 P3-K-T4

Laser light barriers

	Scan width / operating distance, setting range (mm)	Housing design Size (mm)	Sensitivity setting by means of	Transmitter (T) / Receiver (R)	Switching output	Switching frequency (Hz)	Laser class	Ambient temperature (°C)	Housing material	Cable material/length, Plug connector	Connection cable (optionally available)	Product description
	Laser line diffuse sensor rectangular design											
	20 to 70	22 x 13 x 8.5	Potentiometer	-	pnp, 50 mA NO/NC	1,000	1	-10 to +55	Plastic	2.0 m M8	- TK ... /4	LLT 21 K 70 P3 LLT 21 K 70 P3-K-T4
	Laser through-beam sensors rectangular design											
	0 to 1,000	19 x 12 x 8.5	-	T/R	pnp, 50 mA NO/NC	1,000	1	-10 to +55	Plastic	2.0 m M8	- TK ... /4	LES 21 K 1000 P3 LES 21 K 1000 P3-K-T4
	Laser diffuse sensors with optical background suppression, rectangular design											
	30 to 350	40 x 30 x 15	Potentiometer	-	Push-pull, 200 mA NO/NC antivalent	1,000	1	-10 to +50	Metal	M8	TK ... /4	LH 41 M 350 G4L-T4
	Laser diffuse sensors rectangular design											
	75 to 200 100 to 600	50 x 40 x 15	Potentiometer	-	pnp, 200 mA NO/NC	2,000 500	1	-10 to +50	Metal	M12	VK ...	LTV 51 M 200 P3K-IBS LTV 51 M 600 P3K-IBS
	Laser diffuse sensors with background suppression, rectangular design											
	50 to 200	50 x 40 x 15	Potentiometer	-	Push-pull, 200 mA NO/NC	500	1	-10 to +50	Metal	M12	VK ...	LHT 51 M 200 G3-B4 ¹⁾
	Laser diffuse sensors with foreground and background suppression, rectangular design											
	50 to 400	50 x 50 x 16	Teach, Remote teach	-	Push-pull, 200 mA NO/NC	100	1	0 to +50	Aluminum	M12	VK ... /4	LVHT 51 M 400 G3-B4
	Laser retroreflective sensors rectangular design											
	100 to 1,000	50 x 40 x 15	Potentiometer	-	pnp, 200 mA NO/NC	2,000	1	0 to +50	Metal	M12	VK ...	LRV 51 M 1000 P3K-IBS
	200 to 2,000											LRV 51 M 2000 P3K-IBS
1,000 to 10,000	LRV 51 M 10000 P3K-IBS											

	Scan width / operating distance, setting range (mm)	Housing design Size (mm)	Sensitivity setting by means of	Transmitter (T) / Receiver (R)	Switching output	Switching frequency (Hz)	Laser class	Ambient temperature (°C)	Housing material	Cable material/length, Plug connector	Connection cable (optionally available)	
	 Laser diffuse sensors with optical background suppression, rectangular design											Product description
	40 to 400	76 x 30 x 18	Potentiometer	-	Antivalent, 200 mA NO/NC 200 mA, NO switching output NC alarm output	1,000	1	-10 to +60	Metal	M12	VK ... /4	LHT 81 M 300 G4L-IBS LHT 81 M 300 G6L-IBS
	 Laser distance sensors rectangular design											Product description
	200 to 10,000	45 x 52 x 42	Teach	-	pnp, 200 mA NO/NC programmable	5	2	-10 to +60	Metal	M12	VK ...	LHT 9-45 M 10 P3-B4
	 Laser line retroreflective sensors rectangular design											Product description
	50 to 500	50 x 40 x 15	Potentiometer	-	pnp, 200 mA NO/NC	750	1	5 to +50	Metal	M12	VK ...	LLRV 51 M 500 P3K-IBS
	 Laser line diffuse sensor with background suppression, rectangular design											
	50 to 200	50 x 40 x 15	Potentiometer	-	Push-pull, 200 mA NO/NC	500	1	-10 to +50	Metal	M12	VK ...	LLH 51 M 200 G3-B4

¹⁾ Increased function reserve

Laser line diffuse sensors

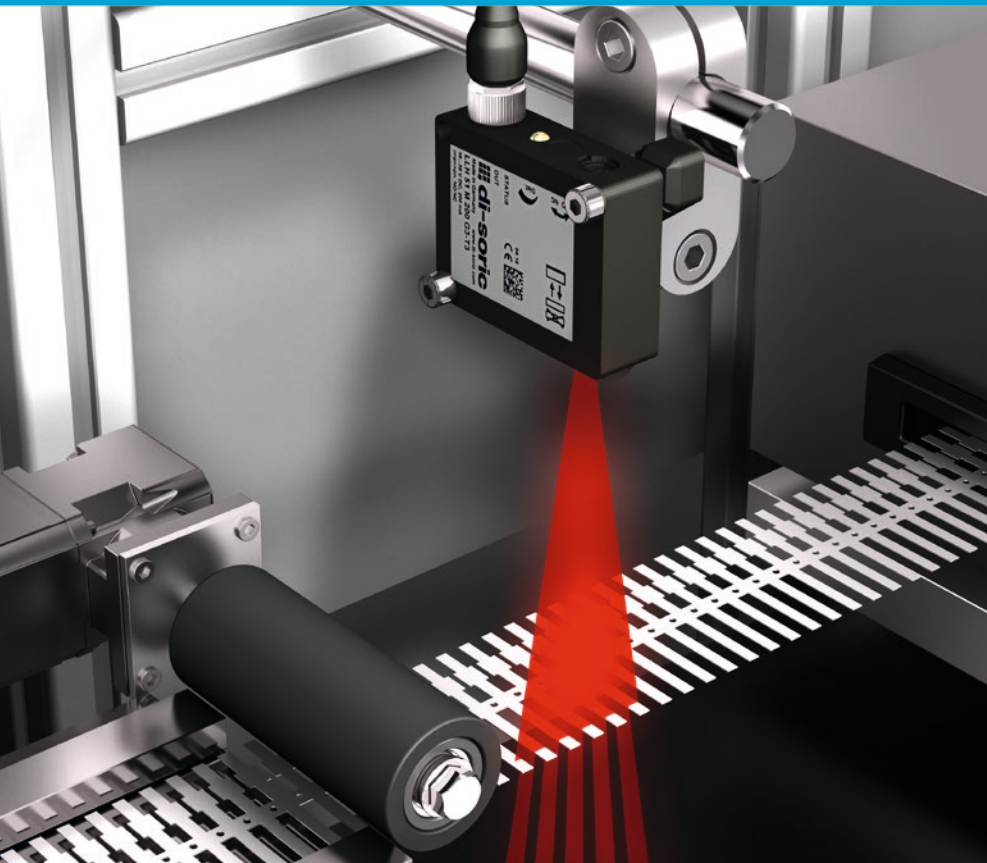

One of the new products in laser class 1 is the laser line diffuse sensor with background suppression from the LLH 51 series.

The sensor has a laser line that enables detection of imprecisely positioned objects or objects with cavities.

The laser line features a width of up to 30 mm, enabling the detection of components such as printed circuit boards with holes at scan widths of up to 200 mm.

Laser line diffuse sensors with background suppression LLH 51 ...

- Detecting objects with irregular cavities, openings or holes
- Detecting non-guided parts
- 30 x 1.5 mm laser line at a scan width of 20 mm
- Automatic adjustment of transmitting power
- Red-light laser
- Laser class 1
- 4-turn potentiometer
- Electronic background suppression
- Light/dark switching
- Robust metal housing



Technical data (typ.)	+20°C, 24 VDC
Service voltage	10 to 35V DC
Switching output	200mA, push-pull, NO/NC
Laser class	1 (IEC 60825-1)
Ambient light immunity	5 kLx
Ambient temperature	-10 to +50°C
Protection type	IP 67
Protection class	III, operation on protective low voltage
Housing material	Die-cast zinc, varnished
Window material	Polycarbonate

	<i>Operating distance / setting range (mm)</i>	<i>Min. teach range (mm)</i>	<i>Red-light laser, clocked, 650 nm</i>	<i>Sensitivity adjustment by means of</i>	<i>Laser line at scan width (mm)</i>	<i>No-load current (mA)</i>	<i>Switching frequency (Hz)</i>	<i>Hysteresis</i>	<i>Cable material/length, Plug connector length</i>	<i>Connection cable (optionally available)</i>		
	Laser line diffuse sensors with background suppression										Product description	
	50 to 200	50	■	Potentiometer	30x1.5 (200)	25	500	6%	M8	TK ...		LLH 51 M 200 G3-T3
									M12	VK ...		LLH 51 M 200 G3-B4

Application example

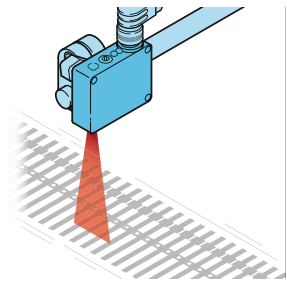

- 30 x 1.5 mm laser line at a scan width of 200 mm
- Detecting objects with irregular cavities, openings or holes
- Detecting non-guided parts

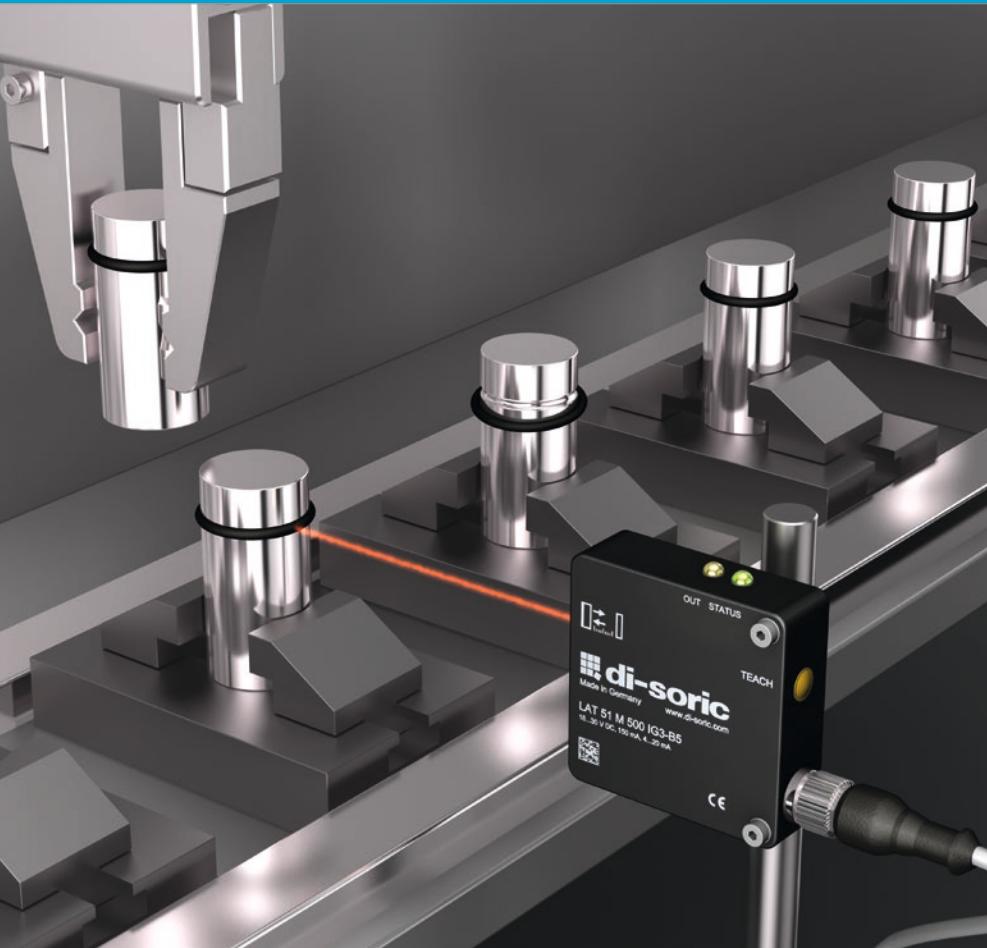

Laser distance sensors with switching output and/or analog output operate with laser light. The application areas extend from monitoring height and sag on conveyor belts to measuring distance on linear units.

Laser distance sensors

LAT 51 ...

- Red-light laser, with small laser spot
- Laser class 1
- Operating distance from 50 to 500 mm
- Laser triangulation process
- Precisely linearized object detection
- Switching output and analog output
- Remote teach option
- Key lock function
- Robust metal housing
- High protection type

Laser distance sensors

LAT 61 ...

- Extremely high resolution
- Laser triangulation process
- Integrated configuration display
- 2 analog and 3 switching outputs
- Timing and multifunction input
- Robust plastic housing
- High protection type







Laser distance sensors

LHT 9-45 ...

- Red-light laser for easy alignment
- High operating distance up to 10 m
- Laser time-of-flight method
- Switching and analog outputs parameterizable
- Four-digit display parameterizable
- Good color and surface independence
- Robust metal housing
- High protection type



Technical data (typ.) +20 °C, 24 VDC	LAT 51 ...	LAT 61 ...	LHT 9-45 ...
Emitted light		Red-light laser, clocked	
Laser class	1	2	2
Switching output 1	Push-pull, 150 mA, short-circuit proof	pnp/npn, 50 mA	pnp, 200 mA, NO/NC programmable
Switching output 2	–	pnp/npn, 50 mA	pnp or analog output
Switching output 3	–	pnp/npn, 50 mA	–
Analog output	4 to 20 mA (IG3-B5) 0 to 10 V (UG3-B5)	4 to 20 mA 0 to 10 V	4 to 20 mA (... P3 IU-B4) 0 to 10 V (... P3 IU-B4)
No-load current	60 mA	< 100 mA	< 150 mA
Ambient temperature	0 to +50 °C	-10 to +45 °C	-10 to +60 °C
Protection type		IP 67	
Protection class		III, operation on protective low voltage	
Housing material	Aluminum, black anodized	Plastic (PBT)	Die-cast zinc, black varnished

	Laser distance sensors	Laser diffuse sensors with background suppression	Analog output (4 to 20 mA)	Analog output (0 to 10 V)	Detection range (mm)	Housing design Size (mm)	Digital display	Service voltage (VDC)	Max. resolution	Max. switching frequency (Hz)	Output sequence frequency (Hz)	Diameter of light spot (mm)	Cable material/length, Plug connector length	Connection cable (optionally available)	
	Laser distance sensors LAT 51 rectangular design														Product description
	■	■	■	■	50 to 500	50 x 50 x 16	■	18 to 30	0.05 to 1.5 mm	500	–	Ø2	M12	VK ... /5	LAT 51 M 500 IG3-B5
										500					LAT 51 M 500 UG3-B5
	Laser distance sensors LAT 61 rectangular design														
	■	■	■	■	30 ± 4	60 x 57 x 20	■	21.6 to 26.4	0.5 µm	–	–	0.1 x 0.1	5.0 m	–	LAT 61 K 30/8 IUPN
				50 ± 10	1.5 µm				0.5 x 1.0	LAT 61 K 50/20 IUPN					
				85 ± 20	2.5 µm				0.75 x 1.25	LAT 61 K 85/40 IUPN					
				120 ± 60	8.0 µm				1.0 x 1.5	LAT 61 K 120/120 IUPN					
	Laser distance sensors LHT 9-45 rectangular design														
	■	■	■	■	200 to 10,000	45 x 52 x 42	■	10 to 30	–	5	–	Ø6	M12	VK ...	LHT 9-45 M 10 P3-B4
								18 to 30		5	1 to 33			VK ... /4	LHT 9-45 M 10 P3IU-B4

High-performance light barriers

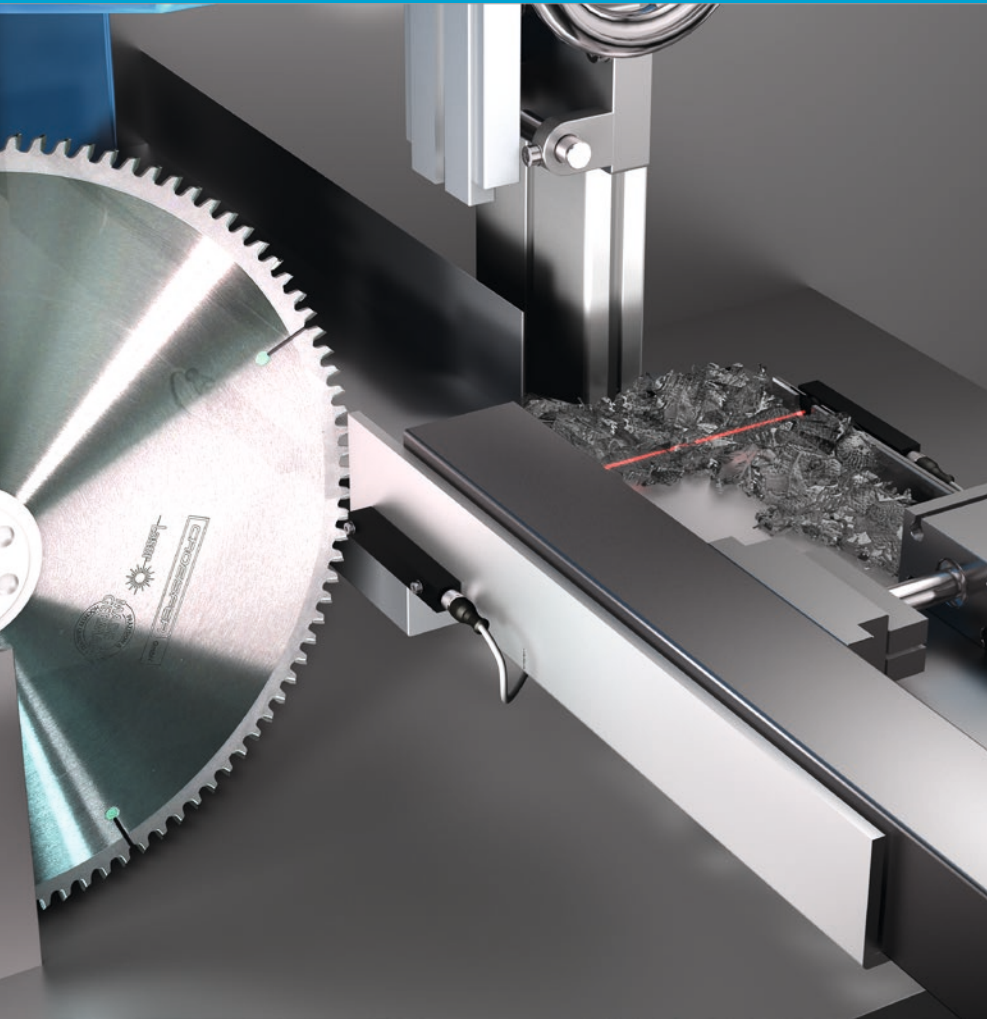

High-performance light barriers are the power variants of the various series of light barriers. Their extremely high performance reliably penetrates swarf, dust, oil, and dirty water.

High-performance light barriers

- High switching accuracy
- Extremely dirt-resistant
- Operating distances of up to 50 m
- Protection class IP 67, IP 68 and IP 69K
- Variants with a switchable heating element
- Variants with a stainless steel housing
- Integrated alignment aid (OEVP 50)



Technical data (typ.)	+20 °C, 24 VDC
Emitted light	Infrared light, clocked
Service voltage	10 to 35V DC
Ambient temperature	-10 to +60 °C
	-20 to +60 °C (OxP 12 ...)
	-40 to +50 °C (.../H / heating element ¹⁾)

Operating distance (opening angle 15°) when operated with OSP 12 VLF ... / OSPQ 12 MLFL ... (m)	Operating distance (opening angle 6°) when operated with OSP 12 VHF ... / OSPQ 12 MHFL ... (m)	Housing design Size (mm)	Transmitter (T) / Receiver (R)	Dispersion angle / opening angle	Switching output	NC (nnp) / NO (npr)	NO (nnp) / NC (npr)	NO/NC	Switching frequency (Hz)	Protection type	Housing material	Plug connector	Connection cable (optionally available)
---	--	--------------------------	--------------------------------	----------------------------------	------------------	---------------------	---------------------	-------	--------------------------	-----------------	------------------	----------------	---

High-performance through-beam sensors cylindrical design													Product description	
	-	-	M12 x 60	T	15° 6°	-				-	IP 67, IP 68, IP 69K	Stainless steel V2A	PVC, 5 m	OSP 12 VLF-5M ²⁾ OSP 12 VHF-5M ²⁾
	1	5	M12 x 60	E	Push-pull 200 mA	■	■		500	IP 67, IP 68, IP 69K	Stainless steel V2A	PVC, 5 m	OEP 12 V 5000 G1L-5M OEP 12 V 5000 G2L-5M	
	6	20				■	■		150				OEP 12 V 20000 G1L-5M OEP 12 V 20000 G2L-5M	
	20	50				■	■		20				OEP 12 V 50000 G1L-5M OEP 12 V 50000 G2L-5M	
	-	-	M12 x 75	T	15° 6°	-				-	IP 67, IP 68, IP 69K	Stainless steel V2A	M12 VK ...	OSP 12 VLF-IBSL ²⁾ OSP 12 VHF-IBSL ²⁾
	1	5	M12 x 75	E	Push-pull 200 mA	■	■		500	IP 67, IP 68, IP 69K	Stainless steel V2A	M12 VK ...	OEP 12 V 5000 G1-IBSL OEP 12 V 5000 G2-IBSL	
	6	20				■	■		150				OEP 12 V 20000 G1-IBSL OEP 12 V 20000 G2-IBSL	
	20	50				■	■		20				OEP 12 V 50000 G1-IBSL OEP 12 V 50000 G2-IBSL	

High-performance through-beam sensors rectangular design													Product description	
	-	-	12 x 12 x 82	T	15° 6°	-				-	IP 67	Aluminum, anodized	PVC, 5 m	OSPQ 12 MLFL-5M ²⁾ OSPQ 12 MHFL-5M ²⁾
	1	5	12 x 12 x 82	E	Push-pull 200 mA	■	■		500	IP 67	Aluminum, anodized	PVC, 5 m	OEPQ 12 M 5000 G1L-5M OEPQ 12 M 5000 G2L-5M	
	6	20				■	■		150				OEPQ 12 M 20000 G1-5M OEPQ 12 M 20000 G2L-5M	
	20	50				■	■		20				OEPQ 12 M 50000 G1L-5M OEPQ 12 M 50000 G2L-5M	
	-	-	12 x 12 x 82	T	15° 6°	-				-	IP 67	Aluminum, anodized	M8 TK ...	OSPQ 12 MLF-TSSL ²⁾ OSPQ 12 MHF-TSSL ²⁾
	1	5	12 x 12 x 82	E	Push-pull 200 mA	■	■		500	IP 67	Aluminum, anodized	M8 TK ...	OEPQ 12 M 5000 G1-TSSL OEPQ 12 M 5000 G2-TSSL	
	6	20				■	■		150				OEPQ 12 M 20000 G1-TSSL OEPQ 12 M 20000 G2-TSSL	
	20	50				■	■		20				OEPQ 12 M 50000 G1-TSSL OEPQ 12 M 50000 G2-TSSL	
	50	50	50 x 40 x 15	T	-	Push-pull, 200 mA				-	IP 67	Die-cast zinc	M12 VK ...	OSP 50 M 50000-IBS O EVP 50 M 50000 G3LK-IBS
	50	50	50 x 40 x 15	E	-	Push-pull 200 mA				20	IP 67	Die-cast zinc	M12 VK ... /4	OSP 50 M 50000-IBS/H ¹⁾ O EVP 50 M 50000 G3LK-IBS/H ¹⁾

²⁾ Function modules FM 70-1 ... for adjusting the transmitting power and activating the test function; see the Accessories chapter

Fork light barriers

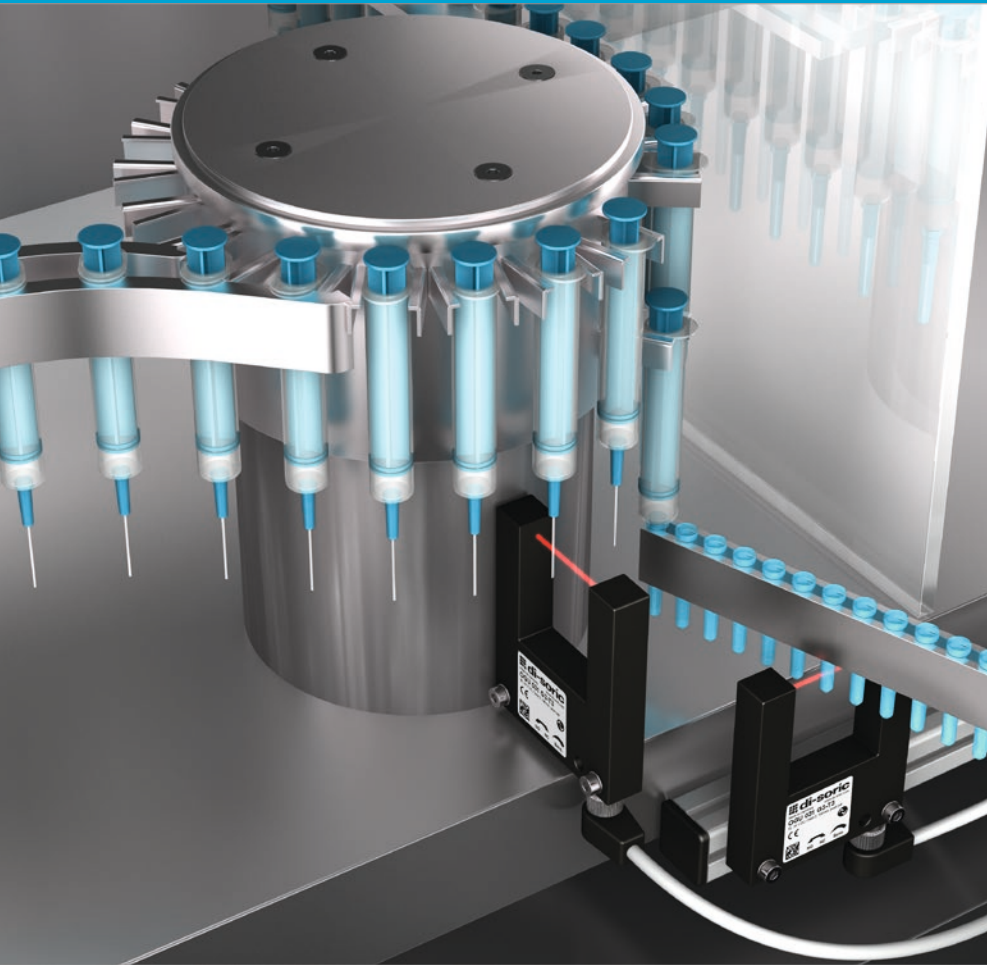

di-soric fork light barriers operate on the functional principle of through-beam sensors. The transmitters, receivers and all of the electronics are in a housing, which ensures the easiest and fastest installation.

This eliminates the need for complex brackets for fastening transmitters and receivers and time-intensive adjustments. di-soric fork light barriers have a robust metal housing and satisfy protection class III (operation on protective extra low voltage); in addition, the electronics are protected against overload, short-circuit and polarity reversal.

- Fork widths from 5 to 250 mm
- Sensitivity is adjustable
- Light/dark switching
- High switching frequency
- High reproducibility
- Bright ring LED
- Robust housing
- 5-year warranty*

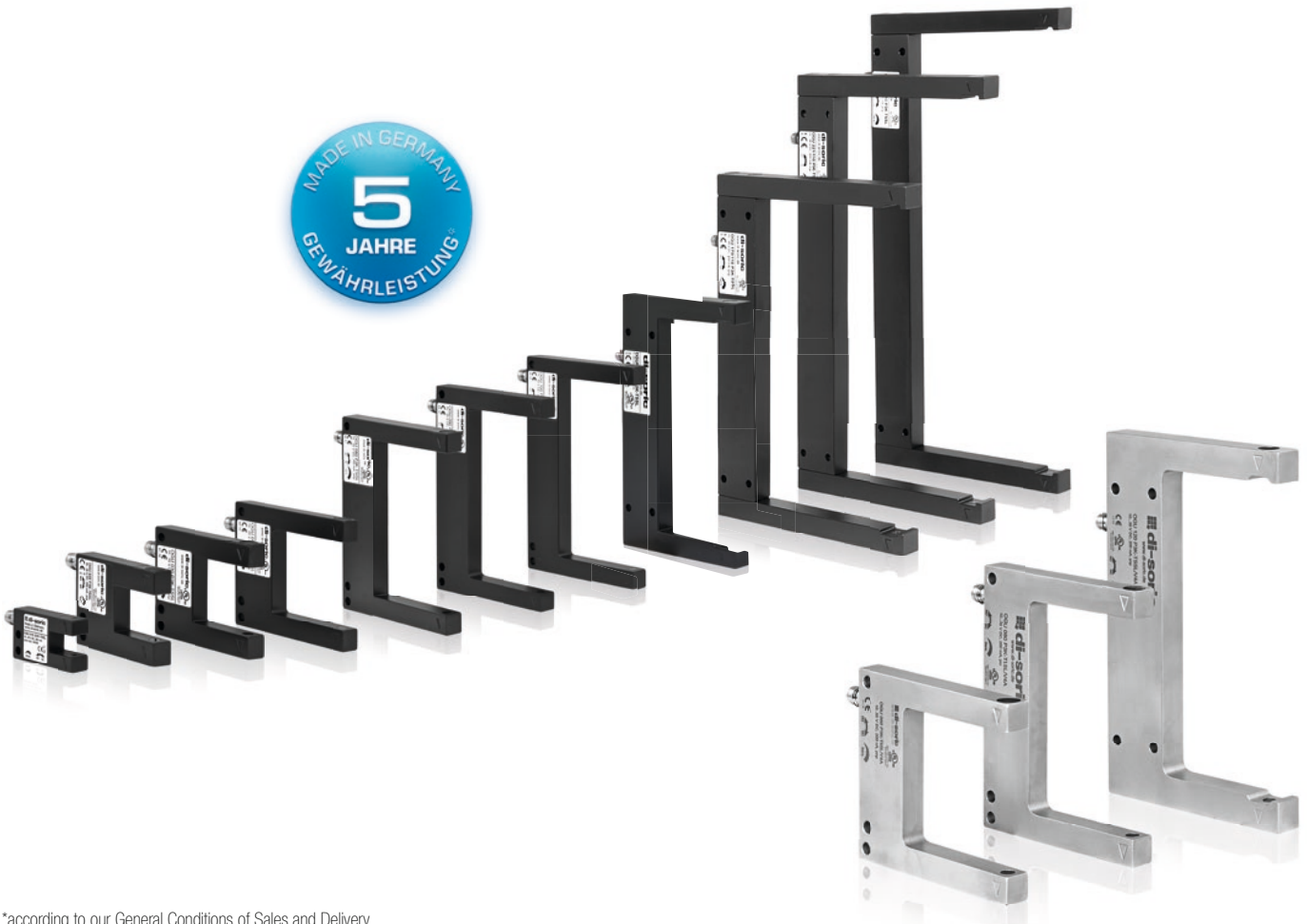

*according to our General Conditions of Sales and Delivery

Fork light barriers with IO-Link

This new generation of fork light barriers features a higher switching frequency and a high level of reproducibility at a higher resolution. This expands the range of applications of these devices for dynamic tasks and applications that require high-precision detection of parts and positioning. The integrated IO-Link interface supports application-specific device configuration. Consequently, these sensors can be adapted to the application ideally and the process stability can be monitored. The devices are available with clocked infrared or red light and have a high ambient light immunity.

Technical data (typ.)	+20 °C, 24 VDC
Service voltage	10 to 30 V DC
No-load current	40 mA
Switching output	Push-pull (pnp/npn can be adjusted by IO-Link) 100 mA, NO/NC (can be switched by potentiometer)
Sensitivity adjustment	Adjustable (potentiometer)
Ambient temperature	-10 to 60 °C
Protection type	IP 67
Operation modes	Standard (general applications) High Resolution (for detecting very small objects) Power (increased function reserve) Speed (reliable detection of fast-moving parts)
Plug connector	M8, 3-pin
Connection cable	TK... (optionally available)



NEW



Operation modes	
<p>Standard – General applications</p> <ul style="list-style-type: none"> 5 kHz OGU 03x – 12x Reproducibility: 0.02 mm 	<p>Power – Increased function reserve</p> <ul style="list-style-type: none"> Increased transmitting power,
<p>High Resolution – For detecting very small objects</p> <ul style="list-style-type: none"> 30% better reproducibility and resolution 	<p>Speed – Reliable detection of fast-moving parts</p> <ul style="list-style-type: none"> 30% higher switching frequency

	Fork width (mm)	Housing design Size (mm)	Red light, 660 nm, clocked	Infrared light, 880 nm	Resolution, smallest detectable part (mm)	Voltage drop (V)	Adjustable switching frequency (Hz)	Reproducibility (mm)	Die-cast zinc, powder-coated	Aluminum, black varnished/oxidized	Product description
	10	25 x 45 x 10		■	Ø 0.3 (min. Ø 0.2)	1.0	10,000 (max. 14,000)	0.02	■		OGU 010 G3-T3
	20	40 x 50 x 10	■	■	Ø 0.3 (min. Ø 0.2)	1.0	5,000 (max. 8,000)	0.02	■		OGU 020 G3-T3 OGU 021 G3-T3
	30	50 x 60 x 10	■	■	Ø 0.3 (min. Ø 0.2)	1.0	5,000 (max. 8,000)	0.02	■		OGU 030 G3-T3 OGU 031 G3-T3
	40	60 x 70 x 10	■		Ø 0.3 (min. Ø 0.2)	1.0	5,000 (max. 8,000)	0.02	■		OGU 041 G3-T3
	50	70 x 80 x 10	■	■	Ø 0.3 (min. Ø 0.2)	1.0	5,000 (max. 8,000)	0.02	■		OGU 050 G3-T3 OGU 051 G3-T3
	60	80 x 80 x 10	■		Ø 0.3 (min. Ø 0.2)	1.0	5,000 (max. 8,000)	0.02		■	OGU 061 G3-T3
	70	90 x 80 x 10	■		Ø 0.3 (min. Ø 0.2)	1.0	5,000 (max. 8,000)	0.02		■	OGU 071 G3-T3

Fork light barriers

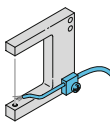
	Fork width (mm)	Housing design Size (mm)	Red light, 660 nm, clocked	Infrared light, 880 nm	Resolution, smallest detectable part (mm)	Voltage drop (V)	Adjustable switching frequency (Hz)	Reproducibility (mm)	Die-cast zinc, powder-coated	Aluminum, black varnished/anodized	
	Fork light barriers with IO-Link										Product description
	80	100 x 80 x 10	■	■	Ø0.3 (min. Ø0.2)	1.0	5,000 (max. 8,000)	0.02	■		OGU 080 G3-T3 OGU 081 G3-T3
	90	110 x 80 x 10	■		Ø0.3 (min. Ø0.2)	1.0	5,000 (max. 8,000)	0.02	■		OGU 91 G3-T3
	100	120 x 80 x 10	■		Ø0.3 (min. Ø0.2)	1.0	5,000 (max. 8,000)	0.02	■		OGU 101 G3-T3
	120	144 x 155 x 12	■	■	Ø0.5 (min. Ø0.3)	1.0	5,000 (max. 8,000)	0.02	■		OGU 120 G3-T3 OGU 121 G3-T3
	170	194 x 140 x 12	■		Ø0.5 (min. Ø0.4)	1.0	5,000 (max. 8,000)	0.03	■		OGU 171 G3-T3
	220	244 x 140 x 12	■		Ø1.0 (min. Ø0.8)	1.0	5,000 (max. 6,500)	0.03	■		OGU 221 G3-T3
	250	274 x 140 x 12	■		Ø1.0 (min. Ø0.8)	1.0	5,000 (max. 6,500)	0.03	■		OGU 251 G3-T3
		Air nozzles (FBE)									
	Air nozzles (FBE) See Accessories										

Fork light barriers with increased function reserve

This device series features a high transmitting power. As a result, the devices in this series are particularly well-suited for applications in very dirty environments. Thanks to the increased function reserve, cleaning cycles are reduced to a minimum.

Technical data (typ.)	+20 °C, 24 VDC
Service voltage	10 to 30 VDC (Supply class 2)
Switching output	Push-pull (pnp/npn can be adjusted by IO-Link) 100 mA, NO/NC (can be switched by potentiometer)
Sensitivity adjustment	Adjustable (potentiometer)
Ambient temperature	-10 to 60 °C
Protection type	IP 67
Operation modes	Standard (general applications) High Resolution (for detecting very small objects) Power (increased function reserve) Speed (reliable detection of fast-moving parts)
Plug connector	M8, 3-pin
Connection cable	TK... (optionally available)

NEW



IO-Link

Operation modes



Standard – General applications

- 5 kHz
- Reproducibility: 0.02 mm



Power – Increased function reserve

- Increased transmitting power,



High Resolution – For detecting very small objects

- 30% better reproducibility and resolution



Speed – Reliable detection of fast-moving parts

- 30% higher switching frequency

	Fork width (mm)	Housing design Size (mm)	Infrared light, 860 nm	No-load current (mA)	Resolution, smallest detectable part (mm)	Voltage drop (V)	Switching frequency (Hz)	Reproducibility (mm)	Die-cast zinc, black, powder-coated	
	High-performance fork light barriers									Product description
	20	40 x 50 x 10						0.03		OGUP 020 G3-T3
	30	50 x 60 x 10	■	30	Ø2.0 (min. Ø0,2)	2.8	200 (max 8,000)	0.03	■	OGUP 030 G3-T3
	50	70 x 80 x 10						0.03		OGUP 050 G3-T3
	80	100 x 80 x 10						0.03		OGUP 080 G3-T3
	Air nozzles (FBE)									
	Air nozzles (FBE) See Accessories									

Fork light barriers

Fork light barriers OGU... / V4A are housed in a rugged stainless steel housing. These devices are most notably used in the pharmaceutical, beverage and food industries and meet the special requirements for easy and reliable cleaning using aggressive media.

The integrated IO-Link interface supports application-specific device configuration. As a result, these sensors can be optimized for the respective application and it is possible to monitor process stability. The devices are available with clocked infrared or red light and are highly immune to ambient light influences.

Technical data (typ.)	+20°C, 24 VDC
Service voltage	10 to 35 VDC (Supply class 2)
Switching output	Push-pull (pnp/npn can be adjusted by IO-Link) 100 mA, NO/NC (can be switched by potentiometer)
Sensitivity adjustment	Adjustable (potentiometer)
Ambient temperature	-10 to 60 °C
Protection type	IP 67
Operation modes	Standard (general applications) High Resolution (for detecting very small objects) Power (increased function reserve) Speed (reliable detection of fast-moving parts)
Plug connector	M8, 3-pin
Connection cable	TK... (optionally available)

NEW



IO-Link

Operation modes	
<p>Standard – General applications</p> <ul style="list-style-type: none"> 5 kHz OGU 03x – 12x Reproducibility: 0.02 mm 	<p>Power – Increased function reserve</p> <ul style="list-style-type: none"> Increased transmitting power,
<p>High Resolution – For detecting very small objects</p> <ul style="list-style-type: none"> 30% better reproducibility and resolution 	<p>Speed – Reliable detection of fast-moving parts</p> <ul style="list-style-type: none"> 30% higher switching frequency

	Fork width (mm)	Housing design Size (mm)	Red light, 660 nm, clocked	No-load current (mA)	Resolution, smallest detectable part (mm)	Voltage drop (V)	Switching frequency (Hz)	Reproducibility (mm)	Stainless steel V4A (1.4404 / 1.4571)	
	Fork light barriers, stainless steel housing									Product description
	30	50 x 60 x 10	■	30	Ø0.3 (min. Ø0.2)	1.0	4,000	0.02	■	OGU 031 G3-T3/V4A
	50	70 x 80 x 10	■	30	Ø0.3 (min. Ø0.2)	1.0	4,000	0.04	■	OGU 051 G3-T3/V4A
	80	100 x 80 x 10	■	30	Ø0.3 (min. Ø0.2)	1.0	4,000	0.06	■	OGU 081 G3-T3/V4A
	120	144 x 90 x 12	■	45	Ø0.5 (min. Ø0.2)	1.0	2,000	0.06	■	OGU 121 G3-T3/V4A

	Air nozzles (FBE)	
	Air nozzles (FBE) See Accessories	

Fork light barriers with small fork width

The OGU 005 is the fork light barrier that has the smallest fork width, featuring a high switching precision of 0.01 mm. The compact design is ideal for narrow installation situations.

The devices work with clocked infrared light and have a high ambient light immunity.



Technical data (typ.)	+20 °C, 24 VDC
Service voltage	10 to 35 VDC (Supply class 2)
Switching output	pnp, 200 mA, NO/NC switchable
Sensitivity adjustment	Potentiometer
Ambient temperature	-10 to 60 °C
Protection type	IP 67
Plug connector	M8, 3-pin
Connection cable	TK... (optionally available)

Fork width (mm)	Housing design Size (mm)	Infrared light, 880 nm	No-load current (mA)	Resolution, smallest detectable part (mm)	Voltage drop (V)	Switching frequency (Hz)	Reproducibility (mm)	Aluminum, black varnished/anodized	
Fork light barriers, standard version									Product description
5	25 x 45 x 10	■	35	Ø0.5	2.5	1,000	0.01	■	OGU 005 P1K-TSSL OGU 005 P2K-TSSL

Fork light barriers with teach function

These devices are set using the teach button.

The autoteach function enables teach-in during an ongoing process while having maximum function reserve.



Technical data (typ.)	+20 °C, 24 VDC
Service voltage	10 to 35 VDC (Supply class 2)
Switching output	pnp, 200 mA, NO/NC switchable
Sensitivity adjustment	Teach button
Ambient temperature	-10 to 60 °C
Protection type	IP 67
Plug connector	M8, 3-pin
Connection cable	TK... (optionally available)

Fork width (mm)	Housing design Size (mm)	Red light, 660 nm, clocked	No-load current (mA)	Resolution, smallest detectable part (mm)	Voltage drop (V)	Switching frequency (Hz)	Reproducibility (mm)	Die-cast zinc, varnished	
Fork light barriers, teach function									Product description
30	50 x 60 x 10	■	30	Ø0.3	2.0	3,000	0.03	■	OGUTI 031 P3K-TSSL
50	70 x 80 x 10		30	Ø0.3		3,000	0.03		OGUTI 051 P3K-TSSL
80	100 x 80 x 10		30	Ø0.3		3,000	0.03		OGUTI 081 P3K-TSSL
120	144 x 90 x 12		50	Ø0.7		1,500	0.05		OGUTI 121 G3K-TSSL

Air nozzles (FBE)	Air nozzles (FBE)	
	See Accessories	

Fork light barriers

Fork light barriers, adjustable on the front side

These devices have been developed for applications for which the sensitivity potentiometer has to be operated from the front side for installation reasons.



Technical data (typ.)	+20 °C, 24 VDC
Service voltage	10 to 35 VDC (Supply class 2)
Switching output	pnp, 200 mA, NO/NC switchable
Sensitivity adjustment	Potentiometer
Ambient temperature	-10 to 60 °C
Protection type	IP 67
Plug connector	M8, 3-pin
Connection cable	TK... (optionally available)

	Fork width (mm)	Housing design Size (mm)	Red light, 660 nm, clocked	Infrared light, 880 nm	No-load current (mA)	Resolution, smallest detectable part (mm)	Voltage drop (V)	Switching frequency (Hz)	Reproducibility (mm)	Die-cast zinc, varnished	Aluminum, black varnished/anodized	Product description
	30	50 x 60 x 10	■	■	30	Ø 0.5	2.8	4,000	0.02	■		OGU 030 VP3K-TSSL
	50	70 x 80 x 10	■	■	30	Ø 0.5	2.8	4,000	0.04	■		OGU 031 VP3K-TSSL OGU 050 VP3K-TSSL OGU 051 VP3K-TSSL
	50	70 x 150 x 10	■	■	30	Ø 0.5	2.8	4,000	0.06		■	OGU 050/125 VP3K-TSSL OGU 051/125 VP3K-TSSL
	80	100 x 80 x 10	■	■	30	Ø 0.5	2.8	4,000	0.06		■	OGU 080 VP3K-TSSL OGU 081 VP3K-TSSL
	80	100 x 150 x 10	■		30	Ø 0.5	2.8	4,000	0.06		■	OGU 081/125 VP3K-TSSL
	120	144 x 155 x 12	■		44	Ø 0.8	2.8	2,000	0.06		■	OGU 121/125 VP3K-TSSL

	Air nozzles (FBE)
	Air nozzles (FBE) See Accessories

Differential fork light barriers



This device series features a 2-beam differential evaluation, which can be used for reliably detecting even glass-clear foils as well as objects of less than Ø 0.07 mm (wires, threads, etc.).

Technical data (typ.)

+20 °C, 24 VDC

Service voltage	10 to 35 V DC
Switching output	pnp, 200 mA, NO/NC switchable
Sensitivity adjustment	4-turn potentiometer
Ambient temperature	-10 to 60 °C
Protection type	IP 67
Plug connector	M8, 3-pin
Connection cable	TK... (optionally available)

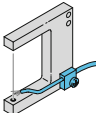

	Fork width (mm)	Housing design Size (mm)	Infrared light, 880 nm	No-load current (mA)	Resolution, smallest detectable part (mm)	Voltage drop (V)	Switching frequency (Hz)	Reproducibility (mm)	Aluminum, black varnished/anodized	
	Differential fork light barriers									Product description
	30	50 x 70 x 10	■	35	Ø0.07	2.5	5,000	0.01	■	ODG 30 P3K-TSSL ¹⁾
	50	70 x 90 x 10			Ø0.1					ODG 50 P3K-TSSL ¹⁾
	90	110 x 115 x 10			Ø0.25					ODG 90 P3K-TSSL ¹⁾
	Air nozzles (FBE)									
	Air nozzles (FBE) See Accessories									

¹⁾Without UL approval

Laser fork light barriers

You can reliably monitor, control, and steer the flow of very small parts using di-soric laser fork light barriers. Very high resolutions can be attained by using collimated laser light.

Laser fork light barriers LGUP ...

- Resolution 100 μm
- Visible laser spot
- Mountable side by side
- High switching frequency
- Reproducibility 20 μm
- Fork widths from 30 to 120 mm
- Laser class 1
- Variants in V4A

- 5-year warranty*

Laser fork light barriers, high-resolution LGU ...





- Resolution 50 μm
- Visible laser spot
- Mountable side by side
- High switching frequency
- Reproducibility 10 μm
- Fork widths from 30 to 120 mm
- Laser class 1
- Aluminum housing, anodized



- 5-year warranty*



*according to our General Conditions of Sales and Delivery

Technical data (typ.)		+20°C, 24 VDC	
Emitted light	Red-light laser, 670 nm, clocked	Laser class	1 - EN 60825-1
Service voltage	10 to 35 VDC (Supply class 2)	Sensitivity adjustment	Potentiometer
Switching output	pnp, 200 mA, NO/NC switchable	Protection type	IP 67
No-load current	30 mA	Plug connector	M8, 3-pin
Switching frequency	3,000 Hz	Connection cable	TK... (optionally available)
Laser power	100 µW		

	Fork width (mm)	Housing design Size (mm)	Resolution, smallest detectable part (mm)	Voltage drop (V)	Switching hysteresis (mm)	Reproducibility (mm)	Ambient temperature (°C)	Die-cast zinc, black varnished	Aluminum, black anodized	Stainless steel V4A	
	Laser fork light barriers, standard version ⚠										Product description
	30	50 x 60 x 10	∅0.1	2.8	50 µm	20 µm	0 to 50	■			LGUP 031 P3K-TSSL
	50	80 x 80 x 10	∅0.1								LGUP 051 P3K-TSSL
	80	100 x 80 x 10	∅0.2								LGUP 081 P3K-TSSL
	120	144 x 90 x 12	∅0.2								LGUP 121 P3K-TSSL
	Laser fork light barriers, stainless steel housing ⚠										
	50	80 x 80 x 10	∅0.1	2.8	50 µm	20 µm	0 to 50		■		LGUP 051 P3K-TSSL/V4A
	80	100 x 80 x 10	∅0.2								LGUP 081 P3K-TSSL/V4A
	120	144 x 90 x 12	∅0.2								LGUP 121 P3K-TSSL/V4A

	Fork width (mm)	Housing design Size (mm)	Resolution, smallest detectable part	Voltage drop (V)	Switching hysteresis (mm)	Reproducibility (mm)	Ambient temperature (°C)	Die-cast zinc, black varnished	Aluminum, black anodized	Stainless steel V4A	
	Laser fork light barriers, high-resolution ⚠										
	30	60 x 60 x 10	50 µm	2.8	20 µm	10 µm	5 to 45	■			LGU 031 P3K-TSSL
	50	80 x 80 x 10									LGU 051 P3K-TSSL
	80	110 x 80 x 10									LGU 081 P3K-TSSL
	120	150 x 90 x 12									LGU 121 P3K-TSSL

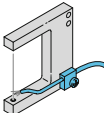
	Air nozzles (FBE)	
	Air nozzles (FBE) See Accessories	

Angled light barriers

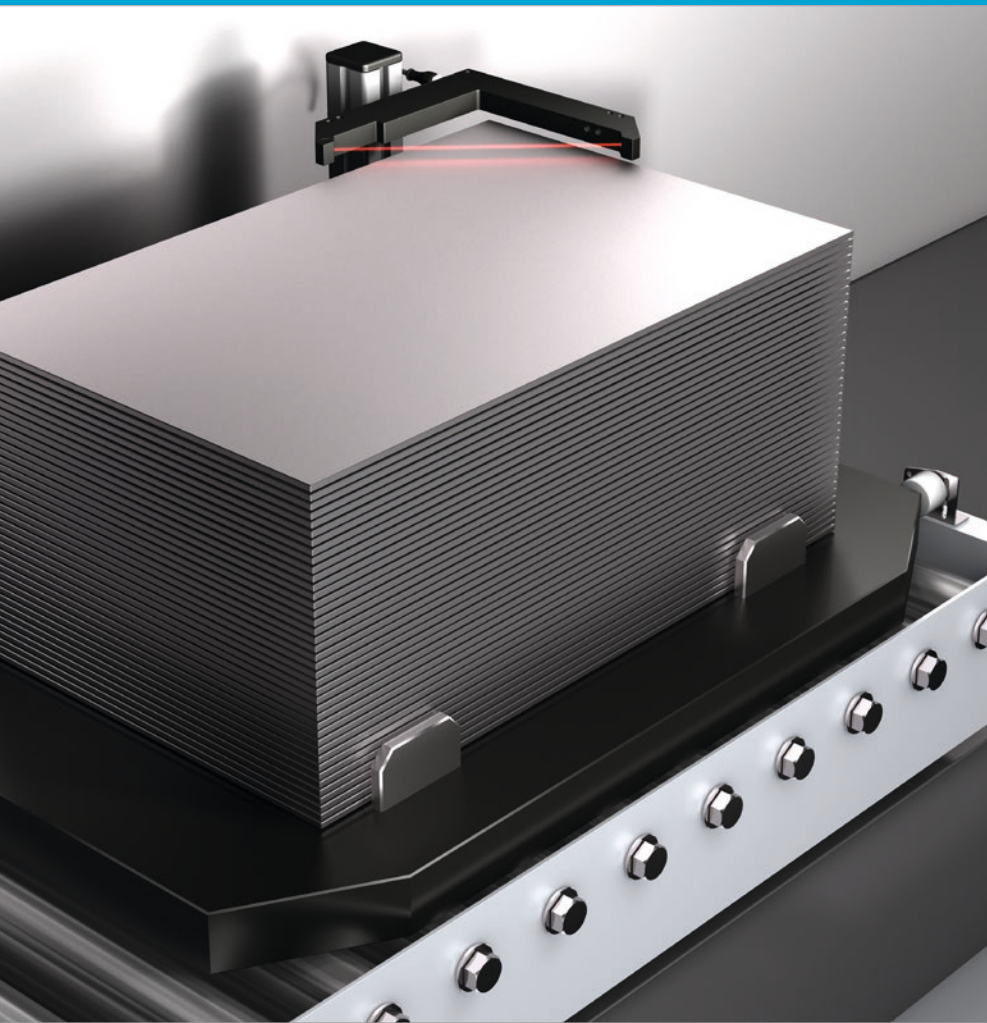

The angled light barrier finds its particular use during removal of workpieces or detection of parts. The high switching frequency, short activation time and high resolution enable maximum positioning accuracy and reliable detection of the fastest motion sequences, even for very small parts.

Angled light barriers

- Red- or infrared-light versions
- High switching frequency
- Sensitivity is adjustable
- Light/dark switching
- Robust metal housing
- All-purpose mounting
- 5-year warranty ¹⁾

Laser angled light barriers

- Very high resolution
- Visible laser spot
- Mountable side by side
- High switching frequency
- Sensitivity is adjustable
- Light/dark switching
- Robust metal housing
- All-purpose mounting
- Laser class 1
- 5-year warranty ¹⁾

High-performance angled light barriers with a contamination indicator/output

- Intelligent contamination output with LED display
- Intelligent contamination indicator
- High function reserve
- Listed in the automotive industry
- Optical axis approachable in x-, y- and z-direction
- All-purpose mounting
- Robust metal housing



Angled light barriers with IO-Link

This new generation of angled light barriers stands out for having a higher switching frequency and a high level of reproducibility at a higher resolution. This expands the range of application of these devices for dynamic tasks and for applications that require high-precision detection of parts and positioning.

The integrated IO-Link interface supports application-specific device configuration. By doing this, these sensors can be optimized for the application and the process stability can be monitored.

The devices are available with clocked infrared or red light and feature a high ambient light immunity.

Technical data (typ.)	+20°C, 24 VDC
Service voltage	10 to 35 VDC (Supply Class 2)
Switching output	Push-pull (pnp/npn can be adjusted by IO-Link) 100 mA, NO/NC (can be switched by potentiometer)
Sensitivity adjustment	Adjustable (potentiometer)
Ambient temperature	-10 to +60°C
Protection type	IP 67
Operation modes	Standard (general applications) High Resolution (for detecting very small objects) Power (increased function reserve) Speed (reliable detection of fast-moving parts)
Plug connector	M8, 3-pin
Connection cable	TK ... (optionally available)



Operation modes	
<p>Standard – General applications</p> <ul style="list-style-type: none"> 5 kHz Reproducibility: 0.02 mm 	<p>Power – Increased function reserve</p> <ul style="list-style-type: none"> Increased transmitting power,
<p>High Resolution – For detecting very small objects</p> <ul style="list-style-type: none"> 30% better reproducibility and resolution 	<p>Speed – Reliable detection of fast-moving parts</p> <ul style="list-style-type: none"> 30% higher switching frequency

	Length of the optical axis (mm)	Housing design Size (mm)	Red light, 660 nm	Infrared light, 880 nm	No-load current (mA)	Resolution (mm)	Switching frequency (Hz)	Reproducibility (mm)			Die-cast zinc, black powder-coated	
	Angled light barriers											Product description
50	75 x 75 x 10	■	■	< 30	∅0.3 (min. ∅0.2)	4,000	0.06	■				OGL 051 G3-T3 ¹⁾ OGL 050 G3-T3 ¹⁾
80	105 x 105 x 10	■	■	< 30	∅0.3 (min. ∅0.2)	4,000	0.06	■				OGL 081 G3-T3 ¹⁾ OGL 080 G3-T3 ¹⁾
120	150 x 150 x 12	■	■	< 40	∅0.5 (min. ∅0.4)	2,000	0.06	■				OGL 121 G3-T3 ¹⁾ OGL 120 G3-T3 ¹⁾

¹⁾ according to our General Conditions of Sales and Delivery

Angled light barriers

Angled light barriers with power electronics

Devices with power electronics feature greater transmitting power. They are available for applications in dirty environments. Versions with an integrated contamination indicator and a corresponding output complete the product range.

Thanks to the increased function reserve, cleaning cycles are reduced to a minimum.

Technical data (typ.)	+20°C, 24 VDC
Service voltage	10 to 35 V DC
Voltage drop	< 2.8 V
Switching hysteresis	< 0.25 mm
Ambient temperature	-10 to +60 °C
Protection type	IP 67
Plug connector	M12, 4-pin
Connection cable	VK .../4 (optionally available)



	Length of the optical axis (mm)	Housing design Size (mm)	Red light, 660 nm	Switching output	Contamination output	No-load current (mA)	Switching frequency (Hz)		Die-cast zinc, natural	
	High-performance angled light barriers, contamination indicator/output									Product description
	40	60 x 83 x 10	■	pnp, 200 mA NO	200 mA	45	200		■	OGL 50/31 P6L-IBS
	60	65 x 106 x 10								OGL 55/54 P6L-IBS

Laser angled light barriers LGL ...



Laser angled light barriers are an advancement of the di-soric angled light barriers. These devices offer extremely high precision in operation and very high repeat accuracy.

The transmitter and receiver optics are protected by a mineral glass screen and are therefore easy to clean. Laser angled light barriers are equipped with a clocked Class 1 red-light laser.

The collimated laser beam creates a clearly visible laser point on the object, which makes mechanical adjustment substantially easier.

Technical data (typ.)	+20 °C, 24 V DC
Service voltage	10 to 35 V DC
Voltage drop	< 2.8 V
Switching hysteresis	< 0.25 mm
Ambient temperature	-10 to +60 °C
Protection type	IP 67
Plug connector	M8, 3-pin
Connection cable	TK ... (optionally available)

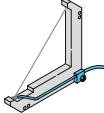

	Length of the optical axis (mm)	Housing design Size (mm)	Red-light laser, 670 nm	Switching output	No-load current (mA)	Resolution (mm)	Switching frequency (Hz)	Reproducibility (mm)	Aluminum, black anodized	
	Laser angled light barriers 									Product description
	50	81 x 81 x 10	■	pnp, 200 mA NO/NC	< 30	Ø0.05	3,000	0.01	■	LGL 051 P3K-TSSL ¹⁾
	80	106 x 106 x 10	■						■	LGL 081 P3K-TSSL ¹⁾
	120	146 x 146 x 12								LGL 121 P3K-TSSL ¹⁾
	Air nozzles (FBE)									
	Air nozzles (FBE) See Accessories									

¹⁾ according to our General Conditions of Sales and Delivery

Frame and ring light barriers

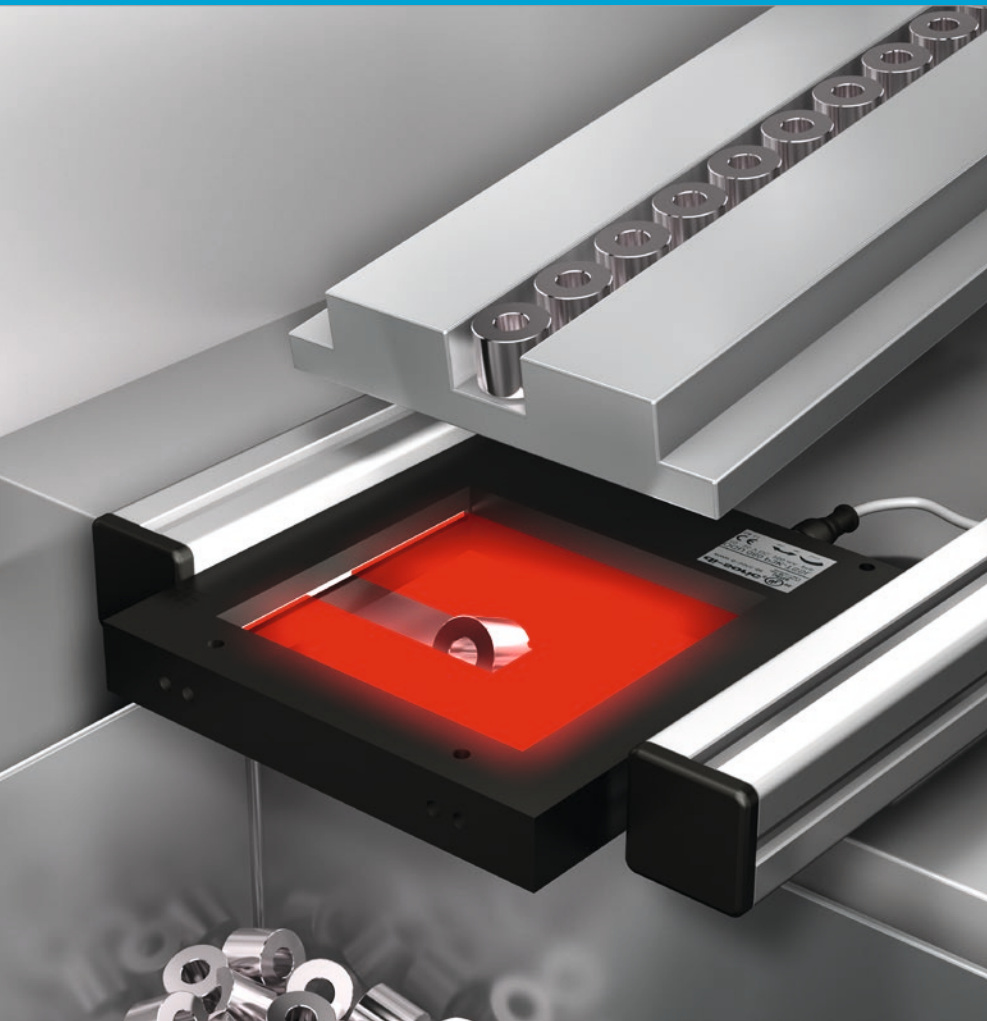

Frame and ring light barriers are used for detecting and counting very small parts and for monitoring the ejection/removal of workpieces in pressing and stamping plants.

Frame light barriers

- Light/dark switching
- Removable crossbar
- Impact protection for protected optics
- Resolution as of $\varnothing 0.7$ mm
- Very short activation time
- Pulse stretching adjustable
- Operating principle static/dynamic switchable
- Air nozzle, optional
- Robust metal housing

Ring light barriers

- Resolution 1.5 mm
- Short activation time
- Pulse stretching adjustable
- Operating principle static/dynamic switchable



Technical data (typ.)	+20°C, 24 VDC	
	OGWSD...	ORSD...
Emitted light	Infrared light, 880 nm	Infrared light, 880 nm
Activation time	0.1 ms	0.1 ms
Release time	0.1 to 150 ms	
Pulse stretching	0.1 to 150 ms	1 to 150 ms
Ambient temperature	0 to 60°C	0 to 60°C
Protection type	IP 67	IP 67
Insulation voltage endurance	500 V	500 V
Housing material	Aluminum, anodized	Plastic PA

Active zone / ring diameter (mm)	Housing design Size (mm)	Functional principle S = static / D = dynamic	Switching output	No-load current (mA)	Resolution, dynamic operation (mm)	Resolution, static operation (mm)	Ambient light immunity (kLx)	Service voltage (VDC)	Plug connector	Connection cable (optionally available)
----------------------------------	--------------------------	---	------------------	----------------------	------------------------------------	-----------------------------------	------------------------------	-----------------------	----------------	---

Frame light barriers											Product description				
	25 x 23	60 x 60 x 15	S/D	pnp	200 mA NO/NC	25	Ø0.7	Ø1.0	30	10 to 35	M8	TK ...	OGWSD 25 P3K-TSSL		
				npn											OGWSD 25 N3K-TSSL
	40 x 49	80 x 125 x 20		pnp		30	Ø0.7	Ø1.0	20	18 to 35			OGWSD 4055 P3K-TSSL		
				npn									OGWSD 4055 N3K-TSSL		
	70 x 62	110 x 123 x 20		pnp		30	Ø1.5	Ø2.0	20	18 to 35			OGWSD 70 P3K-TSSL		
				npn									OGWSD 70 N3K-TSSL		
	100 x 92	140 x 153 x 20		pnp		35	Ø2.5	Ø3.0	20	18 to 35			OGWSD 100 P3K-TSSL		
				npn									OGWSD 100 N3K-TSSL		
	150 x 142	190 x 203 x 20		pnp		45	Ø3.0	Ø5.0	20	18 to 35			OGWSD 150 P3K-TSSL		
				npn									OGWSD 150 N3K-TSSL		
	250 x 242	290 x 303 x 20		pnp		45	Ø5.0	Ø8.0	10	22 to 26			OGWSD 250 P3K-TSSL		
				npn									OGWSD 250 N3K-TSSL		
300 x 397.5	340 x 458.5 x 20	pnp	50	Ø5.0	Ø10.0	8	22 to 26	OGWSD 300 P3K-TSSL							
		npn						OGWSD 300 N3K-TSSL							

Ring light barrier													
	Ø20.6	60 x 85 x 20	S/D	pnp	200 mA NO	30	Ø1.5	Ø1.5	5	10 to 35	M12	VK ...	ORS20 P2K-IBS

Adapter set for ring light barrier ORSD 20 P2K-IBS

- Each with two adapter rings
Ø10 mm / Ø15 mm

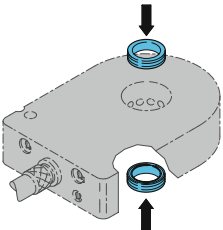
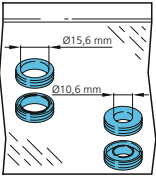
ORS20-AR-10/15

Plastic fiber-optic sensors



Fiber-optic amplifiers and fiber-optic cables are used wherever the space conditions or ambient conditions do not allow for the use of conventional optical devices or only allow their use under certain conditions. The sensitivity is adjusted on the fiber-optic amplifier, which can be installed up to two meters away from the actual detection site, depending on the fiber-optic cable being used.

Amplifiers for plastic fiber-optic cables OLVK 61 ...

- High operating distance
- Easy to operate
- Adjusted with a 12-turn potentiometer
- Light/dark switching switchable
- Version with function reserve output

Amplifiers for plastic fiber-optic cables OLK 71 ...

- High operating distance
- Easy to operate
- Two digital LED displays for the target value and actual value
- Teach-in / fine manual adjustment
- Time function / offset function
- Light/dark switching switchable

Plastic fiber-optic cables

Sensor probes with:

- Straight threaded sleeve
- Smooth sleeve, rigid or flexible
- 90° deflection
- Flat design
- Fixed-focus V-optics
- Ball-shaped optics for cylindrical beam



Technical data (typ.)		+20 °C, 24 VDC	
		OLVK 61 ...	OLK 71 ...
Emitted light		Red light, clocked	Red light, clocked
Switching output		Transistor, 200 mA, NO/NC, switchable	100 mA, NO/NC, programmable
Ambient temperature		-25 to +55 °C	-10 to +55 °C
Protection type		IP 64	IP 54
Housing material		PBTP (Crastin)	ABS / PC

	Housing design Size (mm)	Sensitivity adjustment by means of	Service voltage (V)	Activation time (ms)	Polarity	Digital LED display	Switching hysteresis (%)	Temperature drift (%/K)	No-load current (mA)	Plug connector	Connection cable (optionally available)	Product description
	60 x 31 x 10	Potentiometer	10 to 30	0.33	pnp		10	0.2	15	M8	TK ...	OLVK 61 P3K-TSSL/3
					pnp		10	0.2				TK ... /4
	69 x 33 x 10.5	Teach	12 to 24	0.25 to 1.25	pnp	■			40	M8	TK ... /4	OLK 71 P3-T4
					nnp	■						
	69 x 33 x 10.5	Teach	12 to 24	0.25 to 1.25	pnp	■			40		Cable 2.0 m	OLK 71 P3-3
					nnp	■						

Operating distance specifications for plastic fiber-optic cables













The maximum operating distance specification for fiber-optic cables refers to measurements using the reference amplifier OLK 71 ... with a light intensity of 200% and a standard target of 100x100 mm, white. When using another amplifier or a different amplifier setting, determine the expected range based on the calculation factor.











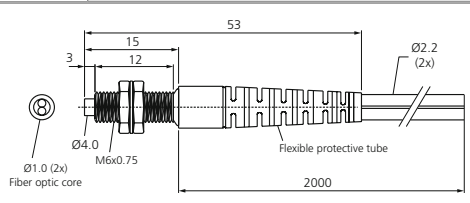









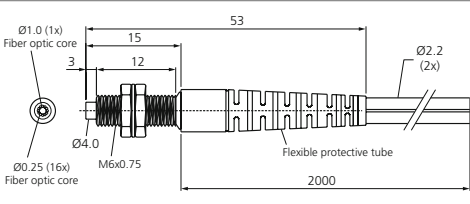









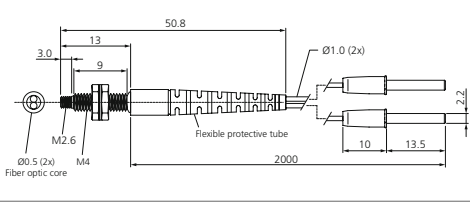









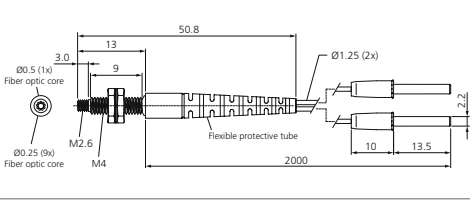







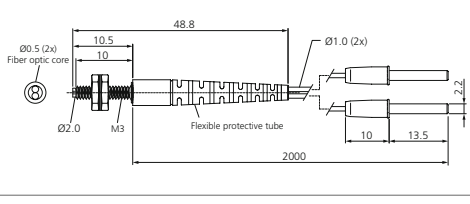

Fiber-optic amplifier	Calculation factor compared to the reference amplifier OLK 71 ... ¹⁾ (typ.)								
OLK 71 ... ¹⁾	100 %			Lichttaster Diffuse reflective sensor Tastkopf (Größe/Material) Sensor probe (Size / Material) Faser Fibre Reichweite ¹⁾ (mm) Operating range ¹⁾ (mm) Auflösung ²⁾ (mm) Resolution ²⁾ (mm) Produktbezeichnung Product-ID	M6 Edelstahl Stainless steel	Parallel 1,0 mm (2x)	200	Ø 0,1	
OLVK 61 P3K-TSSL/3	100 %			Große Reichweite Long operating range KLT-M6-T2-1	M6 Edelstahl Stainless steel	Koaxial 1,0 mm (1x) 0,25 mm (16x)	250	Ø 0,05	
OLVK 61 P3FK-TSSL	100 %			Große Reichweite Kleinteilerkennung Long operating range Small parts detection KLT-M6-T2-1K	M4 Edelstahl Stainless steel	Parallel 0,5 mm (2x)	75	Ø 0,05	
				Genaue Erkennung Optionale Vorsatzoptik Precise detection Optional attachment optics KLT-M4-T2-0.5	M4 Edelstahl Stainless steel	Koaxial 0,5 mm (1x) 0,25 mm (9x)	100	Ø 0,05	
				Kleinteilerkennung Optionale Vorsatzoptik Small parts detection Optional attachment optics KLT-M4-T2-0.5K					

Lichtintensität Light intensity	Faktor Reichweite ¹⁾ Range factor ¹⁾	Ansprechzeit Response time
200 %	100 %	1,25 ms
100 %	75 %	0,63 ms
50 %	70 %	0,42 ms
25 %	40 %	0,31 ms
12 %	25 %	0,25 ms

¹⁾ OLK 71 ... bei Lichtintensität 12 ... 200%
¹⁾ OLK 71 ... at Light intensity 12 ... 200%











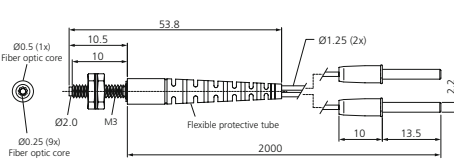

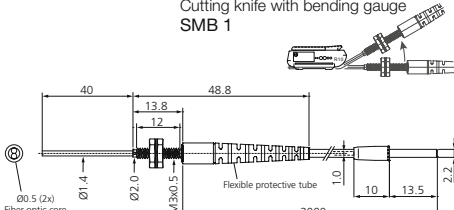

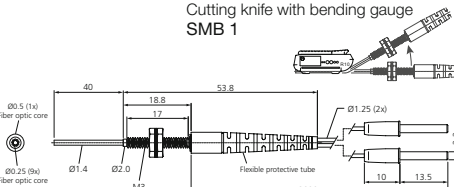
Plastic fiber-optic sensors

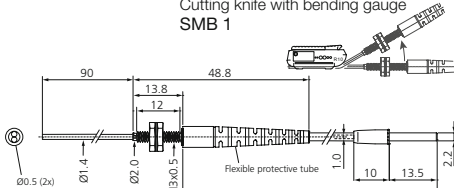
Order information		
 Axial light aperture	 Optional attachment optics	 Minimum permitted bending radius of the fiber-optic cable
 Radial light aperture	 Coaxial fiber arrangement	 Fiber-optic cable can be cut to size, cutting knife included
 Flexible sensor probe	 Ambient temperature	 Fiber-optic cable cannot be cut to size
 Area detection	 Length of the fiber-optic cable	
 Fixed-focus detection	 Cable grommet	

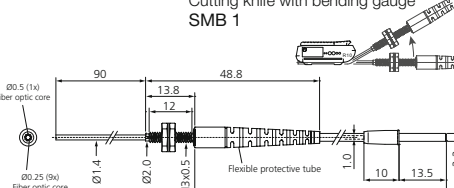
 Plastic fiber-optic cables	Sensor probe (size / material)	Fiber	Operating distance (mm)	Resolution (mm)	Product description
 <p>Technical drawing of KLT-M6-T2-1 sensor probe. Dimensions: 15, 12, 53, 3, 2000, Ø1.0 (2x), Ø4.0, M6x0.75, Ø2.2 (2x), Flexible protective tube.</p>	M6 Stainless steel	Parallel 1.0 mm (2x)	200 ¹⁾	Ø0,1 ²⁾	        
Large operating distance					KLT-M6-T2-1
 <p>Technical drawing of KLT-M6-T2-1K sensor probe. Dimensions: 15, 12, 53, 3, 2000, Ø1.0 (1x), Ø0.25 (16x), M6x0.75, Ø2.2 (2x), Flexible protective tube.</p>	M6 Stainless steel	Coaxial 1.0 mm (1x) 0.25 mm (16x)	250 ¹⁾	Ø0,05 ²⁾	        
Large operating distance Small parts detection					KLT-M6-T2-1K
 <p>Technical drawing of KLT-M4-T2-0.5 sensor probe. Dimensions: 13, 9, 50.8, 3.0, 2000, Ø0.5 (2x), M2.6, M4, Ø1.0 (2x), Flexible protective tube, 10, 13.5, 2.2.</p>	M4 Stainless steel	Parallel 0.5 mm (2x)	75 ¹⁾	Ø0,05 ²⁾	        
Accurate detection Optional attachment optics					KLT-M4-T2-0.5
 <p>Technical drawing of KLT-M4-T2-0.5K sensor probe. Dimensions: 13, 9, 50.8, 3.0, 2000, Ø0.5 (1x), Ø0.25 (9x), M2.6, M4, Ø1.25 (2x), Flexible protective tube, 10, 13.5, 2.2.</p>	M4 Stainless steel	Coaxial 0.5 mm (1x) 0.25 mm (9x)	100 ¹⁾	Ø0,05 ²⁾	        
Small parts detection Optional attachment optics					KLT-M4-T2-0.5K
 <p>Technical drawing of KLT-M3-T2-0.5 sensor probe. Dimensions: 10.5, 10, 48.8, 2000, Ø0.5 (2x), Ø2.0, M3, Ø1.0 (2x), Flexible protective tube, 10, 13.5, 2.2.</p>	M3 Stainless steel	Parallel 0.5 mm (2x)	75 ¹⁾	Ø0,05 ²⁾	        
Accurate detection Optional attachment optics					KLT-M3-T2-0.5

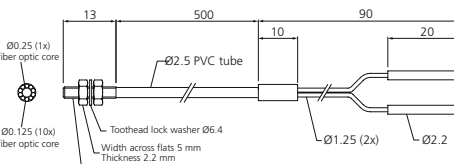
¹⁾ Maximum values (typ.) for a standard target 100 x 100 mm, white.

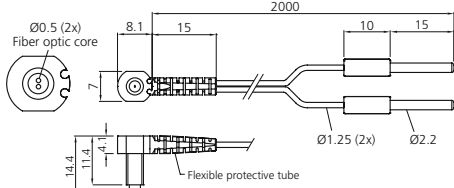





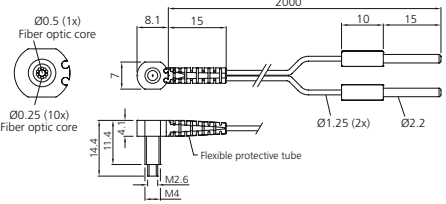
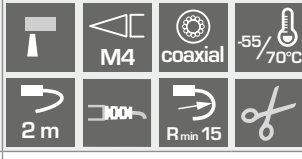
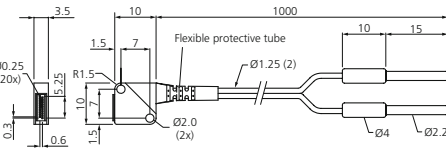

²⁾ Resolution (typ.) for optimal settings and measuring distances (sensor approx. 5 mm, one-way: approx. 100 mm).

 Plastic fiber-optic cables Diffuse sensors	Sensor probe (size / material)	Fiber	Operating distance (mm)	Resolution (mm)	Product description
	M3 Stainless steel	Coaxial 0.5 mm (1x) 0.25 mm (9x)	100 ¹⁾	Ø0,05 ²⁾	
Small parts detection Optional attachment optics					KLT-M3-T2-0.5K
	M3 / Ø1.4 Stainless steel	Parallel 0.5 mm (2x)	75 ¹⁾	Ø0,1 ²⁾	
Flexible sensor probe / R min. > 10mm Accurate detection					KLT-M3-B40-T2-0.5
	M3 / Ø1.4 Stainless steel	Coaxial 0.5 mm (1x) 0.25 mm (9x)	100 ¹⁾	Ø0,05 ²⁾	
Flexible sensor probe / R min. > 10mm Small parts detection					KLT-M3-B40-T2-0.5K
	M3 / Ø1.4 Stainless steel	Parallel 0.5 mm (1x)	75 ¹⁾	Ø0,1 ²⁾	
Flexible sensor probe / R min. > 10mm Accurate detection					KLT-M3-B90-T2-0.5
	M3 / Ø1.4 Stainless steel	Coaxial 0.5 mm (1x) 0.25 mm (9x)	100 ¹⁾	Ø0,05 ²⁾	
Flexible sensor probe / R min. > 10mm Small parts detection					KLT-M3-B90-T2-0.5K
	M3 Stainless steel	Coaxial Ø0.25 (1x) Ø0.125 (10x)	40 ¹⁾	Ø0.02 ²⁾	
Highly accurate detection Optional attachment optics					KLT-M3-S0.5-0.25K
	M4 Stainless steel	Parallel 0.5 mm (2x)	60 ¹⁾	Ø0,1 ²⁾	
Low installation depth 90° deflection Accurate detection Optional attachment optics					KLTR-M4-T2-0.5

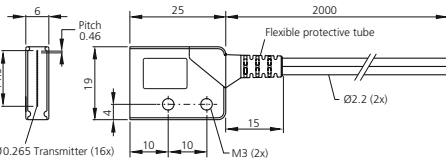
¹⁾ Maximum values (typ.) for a standard target 100 x 100 mm, white.

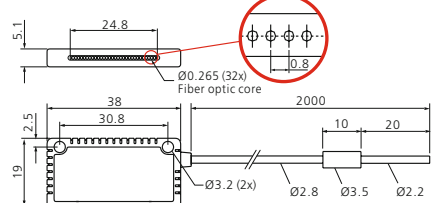
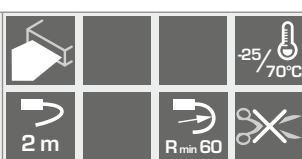
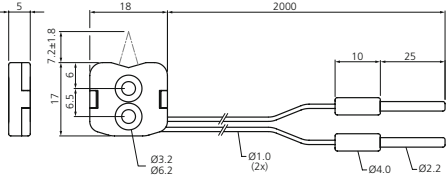
²⁾ Resolution (typ.) for optimal settings and measuring distances (sensor approx. 5mm, one-way: approx. 100 mm).

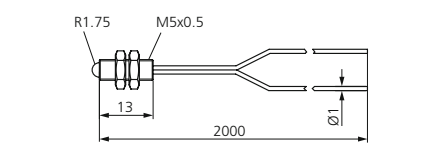
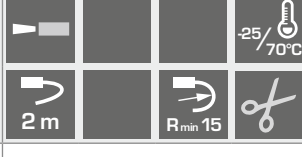
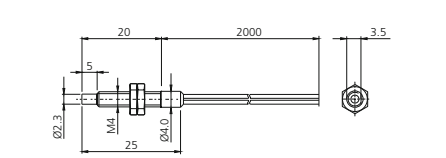
Plastic fiber-optic sensors

	Plastic fiber-optic cables Diffuse sensors	Sensor probe (size/material)	Fiber	Operating distance (mm)	Resolution (mm)	Product description
		M4 Stainless steel	Coaxial 0.5 mm (1x) 0.25 mm (10x)	90 ¹⁾	Ø0,05 ²⁾	 KLTR-M4-T2-0.5K
<p>Low installation depth 90° deflection Small parts detection Optional attachment optics</p>						
		10 x 10 x 3.5 mm Stainless steel	5.25 mm Transmitter 0.265 mm (16x) Receiver	100 ¹⁾	Ø0,1 ²⁾	 KLTM-Q10-T1-5
<p>Area detection without gaps Accurate detection</p>						
		19 x 25 x 6 mm Plastic	14.5 mm Transmitter 0.265 mm (16x) Receiver 0.265 mm (16x)	240 ¹⁾	Ø0,5 ²⁾	 KLTM-Q25K-T1-14
<p>Area detection Large operating distance</p>						
		38 x 19 x 5 mm Plastic	24.8 mm Transmitter 0.265 mm (32x) Receiver	200 ¹⁾	Ø1,0 ²⁾	 KLTMR-Q38K-1-24
<p>Area detection 90° deflection Large operating distance</p>						
		18 x 17 x 5 mm Plastic	A: 7.2 mm parallel Ø0.5 (2x)	5 to 10 ¹⁾	Ø0,1 ²⁾	 KLTVR-Q18-2-10
<p>Fixed-focus detection 90° deflection Low installation depth</p>						
		M5 Edelstahl Stainless steel	0.5 mm	200 ¹⁾	Ø0,1 ²⁾	 WRBT 2000 K-M5-Z8
<p>Ball-shaped optics for cylindrical beam Ø 8 mm</p>						
		M4 Stainless steel	Parallel 0.5 mm (2x)	75 ¹⁾	Ø0,05 ²⁾	 WRBT 2000 K-M4-1.0
<p>Accurate detection Optional attachment optics</p>						

¹⁾ Maximum values (typ.) for a standard target 100 x 100 mm, white.











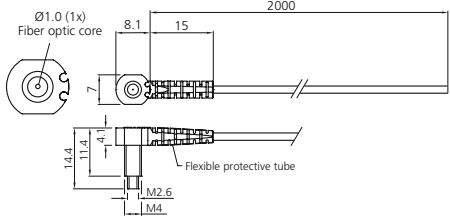







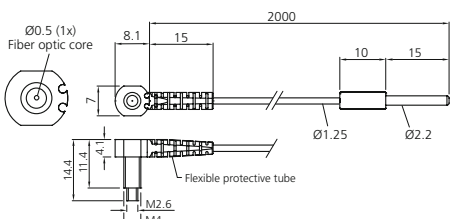







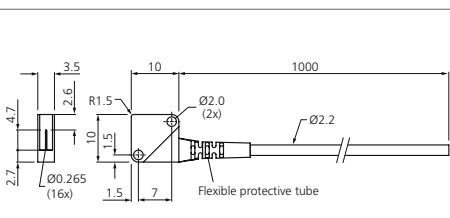





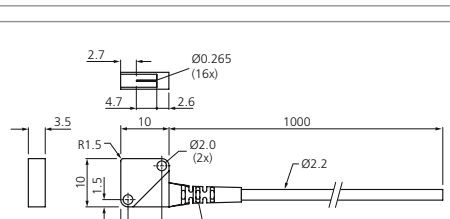





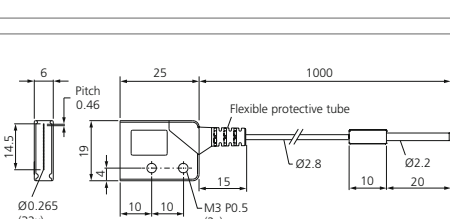





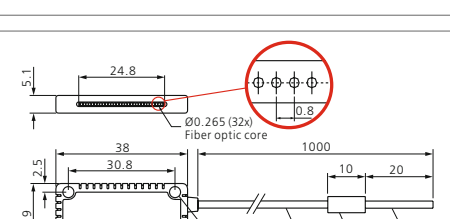

²⁾ Resolution (typ.) for optimal settings and measuring distances (sensor approx. 5 mm, one-way: approx. 100 mm).

	Plastic fiber-optic cables Diffuse sensors	Sensor probe (size / material)	Fiber	Operating distance (mm)	Resolution (mm)	Product description
	2000 $\varnothing 2.0$ M3 13.8 12 6 $\varnothing 1$	M3 Stainless steel	Parallel 0.5 mm (2x)	75 ¹⁾	$\varnothing 0,05$ ²⁾	
Accurate detection Optional attachment optics						WRBT 2000 K-M3-0.5
	20 15 2000 2.5 $\varnothing 2$ $\varnothing 5$ 1.6 7 $\varnothing 2.2$ Seitlicher Lichtaustritt Lateral light emission Klemmbereich Screw tightening range	$\varnothing 5$ Stainless steel	$\varnothing 0.8$ mm	100 ¹⁾	$\varnothing 0,2$ ²⁾	
Low installation depth Small sensor probe						WRBT 2000 KR-5.0-2.0
	Plastic fiber-optic cables Through-beam sensor	Sensor probe (size / material)	Fiber	Operating distance (mm)	Resolution (mm)	Product description
	15 53 3 12 $\varnothing 2.2$ (2x) $\varnothing 1.0$ (1x) Fiber optic core $\varnothing 4.0$ M6x0.75 Flexible protective tube 2000	M6 Stainless steel	1.0 mm	1,000 ¹⁾	$\varnothing 0,2$ ²⁾	
Large operating distance						KLE-M6-T2-1
	13 50.8 3.0 9 $\varnothing 2.2$ $\varnothing 1.0$ (1x) Fiber optic core M2.6 M4 Flexible protective tube 2000	M6 Stainless steel	1.0 mm	1,000 ¹⁾	$\varnothing 0,2$ ²⁾	
Large operating distance						KLE-M4-T2-1
	13 50.8 3.0 9 $\varnothing 2.2$ $\varnothing 0.5$ (1x) Fiber optic core M2.6 M4 Flexible protective tube 2000	M4 Stainless steel	0.5 mm	250 ¹⁾	$\varnothing 0,1$ ²⁾	
Accurate detection Optional attachment optics						KLE-M4-T2-0.5
	10.5 48.8 10 $\varnothing 2.2$ $\varnothing 1.0$ (1x) Fiber optic core $\varnothing 2.0$ M3 Flexible protective tube 2000	M3 Stainless steel	1.0 mm	1,000 ¹⁾	$\varnothing 0,2$ ²⁾	
Large operating distance						KLE-M3-T2-1
	10.5 48.8 10 $\varnothing 1.0$ $\varnothing 2.2$ $\varnothing 0.5$ (1x) Fiber optic core $\varnothing 2.0$ M3 Flexible protective tube 10 13.5 2.2 2000	M3 Stainless steel	0.5 mm	250 ¹⁾	$\varnothing 0,1$ ²⁾	
Accurate detection						KLE-M3-T2-0.5

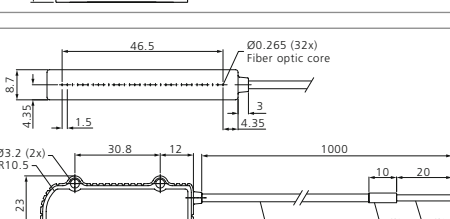
¹⁾Maximum values (typ.) for a standard target 100 x 100 mm, white.

²⁾Resolution (typ.) for optimal settings and measuring distances (sensor approx. 5 mm, one-way: approx. 100 mm).

Plastic fiber-optic sensors

 Plastic fiber-optic cables Through-beam sensor	Sensor probe (size/material)	Fiber	Operating distance (mm)	Resolution (mm)	Product description
	M4 Stainless steel	1.0mm	400 ¹⁾	Ø0,2 ²⁾	      
Low installation depth 90° deflection Large operating distance Optional attachment optics					KLER-M4-T2-1
	M4 Stainless steel	0.5mm	200 ¹⁾	Ø0,1 ²⁾	      
Low installation depth 90° deflection Accurate detection Optional attachment optics					KLER-M4-T2-0.5
	10 x 10 x 3.5mm Stainless steel	4.24 mm 0.265 mm (16x)	200 ¹⁾	Ø0,1 ²⁾	     
Area detection without gaps Large operating distance Accurate detection					KLEM-Q10-T1-4
	10 x 10 x 3.5mm Stainless steel	4.24 mm 0.265 mm (16x)	200 ¹⁾	Ø0,1 ²⁾	     
Area detection without gaps 90° deflection Large operating distance Accurate detection					KLEMR-Q10-T1-4
	19 x 25 x 6 mm Plastic	14.5 mm 0.265 (32x)	1,000 ¹⁾	Ø0,5 ²⁾	     
Area detection Large operating distance					KLEM-Q25K-T1-14
	38 x 19 x 5 mm Plastic	24.8mm 0.265 (32x)	800 ¹⁾	Ø1,0 ²⁾	     
Area detection 90° deflection Large operating distance					KLEMR-Q38K-1-24
	55 x 23 x 9 mm Plastic	46.5mm 0.265 (32x)	800 ¹⁾	Ø2,0 ²⁾	     
Area detection 90° deflection Large operating distance					KLEMR-Q55K-1-46

¹⁾ Maximum values (typ.) for a standard target 100 x 100 mm, white.

²⁾ Resolution (typ.) for optimal settings and measuring distances (sensor approx. 5 mm, one-way: approx. 100 mm).

	Plastic fiber-optic cables Through-beam sensor	Sensor probe (size / material)	Fiber	Operating distance (mm)	Resolution (mm)	Product description			
	Ø 2.98 mm Stainless steel	1.0 mm	600 ¹⁾	Ø0,2 ²⁾					
Low installation depth 90° deflection Large operating distance		KLER-D3-30-S2-1							
	Ø 4.75 mm Stainless steel	Ø0.5 mm	200 ¹⁾	Ø0,05 ²⁾					
Low installation depth 90° deflection Highly accurate object detection		KLER-D4.75-19-S2-0.5							
	10 x 10 x 3 mm Metal	Ø0.5 mm	200 ¹⁾	Ø0,05 ²⁾					
Accurate detection Flat design		KLE-Q10M-1-0.5							
	M6 Brass	Ø 1.0 mm	1,200 ¹⁾	Ø0,2 ²⁾					
Low installation depth Large operating distance		WRBE 2000 KR-M6-1.0							
		Accessories for fiber-optic cables				Accessories for fiber-optic cables; see the Accessories chapter			

¹⁾Maximum values (typ.) for a standard target 100 x 100 mm, white.

²⁾Resolution (typ.) for optimal settings and measuring distances (sensor approx. 5mm, one-way: approx. 100 mm).

Glass fiber-optic sensors

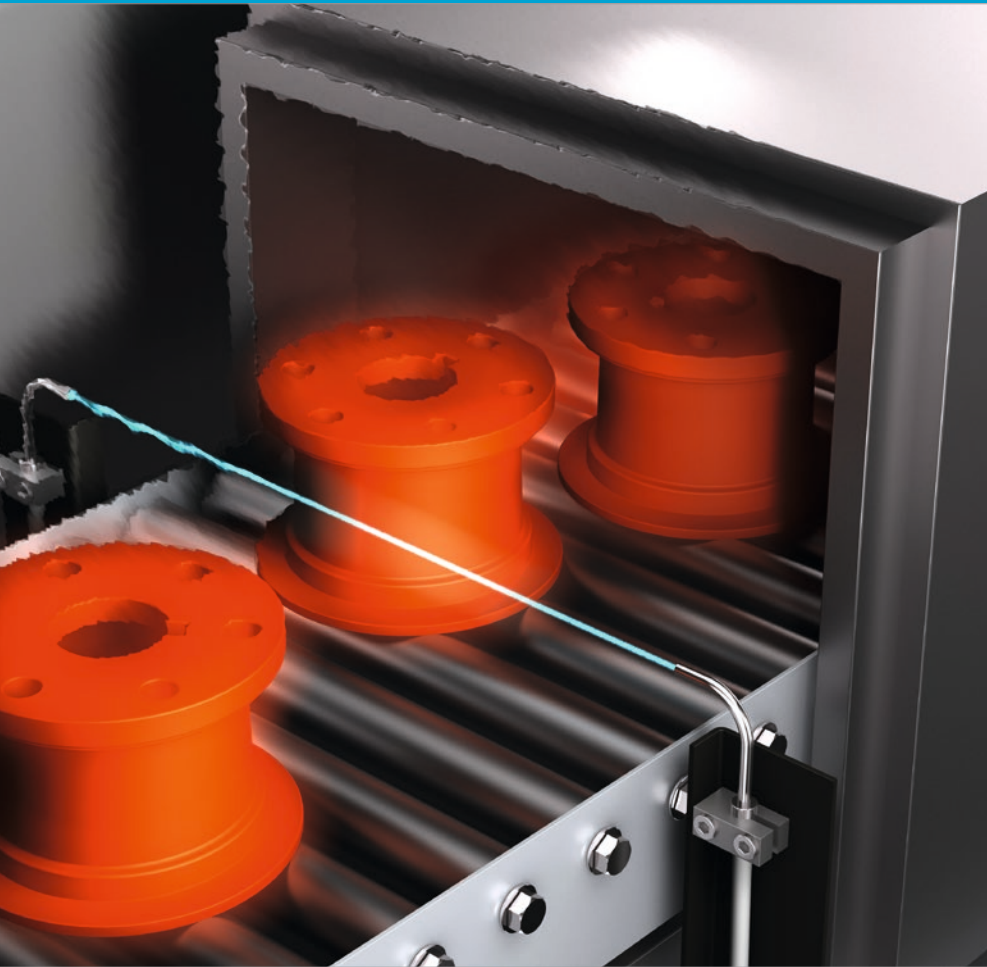

Glass fiber-optic sensors are used in confined spatial conditions.

Glass fiber-optic cables feature high mechanical durability and a large temperature range.

Glass fiber-optic cables

Variants with:

- Silicone-metal sleeve for high mechanical stress and high protection type
- Metal sleeve for high temperatures
- Polyurethane protective jacket
- Wide detection range
- Attachment optics for large operating distances

Amplifiers for glass fiber-optic cables

- Auto-teach and manual teach
- Robust housing made of die-cast zinc
- High scan widths and operating distances
- Green-light variants for detecting glass
- Switch-on/off delay

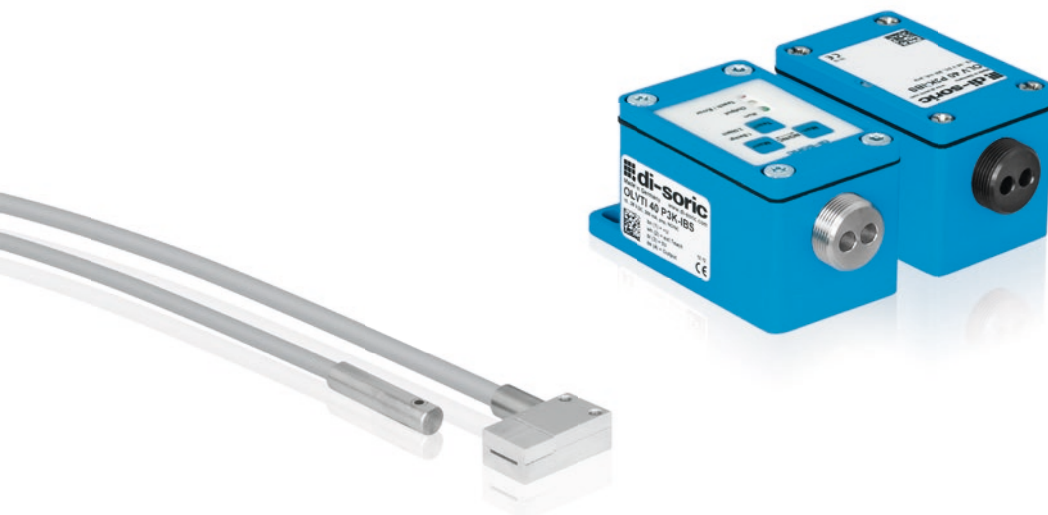

Technical data (typ.)
+20 °C, 24 VDC
Amplifiers for glass fiber-optic cables OLV ...

Switching output	Transistor, pnp, 200 mA, NO/NC, switchable
Ambient temperature	-10 to +60 °C
Housing material	Die-cast zinc
Protection type	IP 65

	Housing design Size (mm)	Sensitivity adjustment by means of	Service voltage (V)	Switching frequency (KHz)	Infrared light, clocked	Red light, clocked	Green light, clocked	Switching hysteresis (%)	Temperature drift (%/K)	Ambient light immunity (KLx)	No-load current (mA)	Plug connector	Connection cable (optionally available)	
Amplifiers for glass fiber-optic cables														Product description
	40 x 41 x 75	Potentiometer	12 to 35	1.5	■									OLV 40 P3K-IBS
				1.5		■		10	0.3	20	55	M12	VK ... /4	OLV 41 P3K-IBS
				0.5			■							
	40 x 41 x 75	Potentiometer	12 to 35	1.5	■			10	0.3	20	55	Clamps		OLV 40 P4K
						■								
	40 x 41 x 75	Teach	10 to 35	1.5	■	■		12	0.1	50	45	M12	VK ... /4	OLVTI 40 P3K-IBS
									0.25					

Technical data (typ.)
+20 °C, 24 VDC
Glass fiber-optic sensors WRB ... (see pages 50-53)

Housing material	V2A
	Aluminum (...SQ... / ...MQ... / WRB 220 SW)
Single fiber	50 µm
Opening angle	67°
Temperature resistance	-40 to +180 °C, for short periods up to +250 °C (silicone-metal sleeve)
	-40 to +180 °C, for short periods up to +300 °C (metal sleeve)

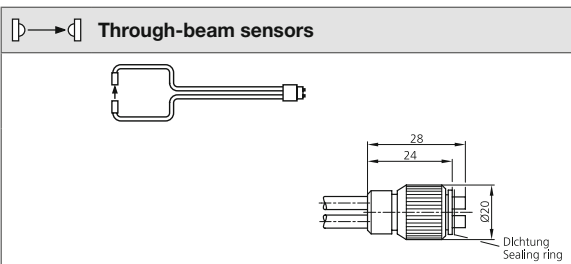
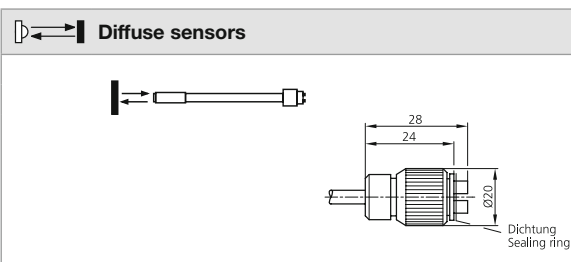

Installation instructions for glass fiber-optic cables

- For permanently installed fiber-optic cables.
- All specified scan widths and operating distances are average values in conjunction with the fiber-optic amplifier in infrared light. If necessary, adjust the sensitivity range using the basic sensitivity potentiometer P2. The specified scan widths and operating distances are reduced to about 80% in red light and to about 30% in green light. The values depend on the fiber-optic cables and on the object to be scanned (size, shape, surface, color, etc.).
- With attachment optics and axial light aperture. Only possible for fiber-optic cables of corresponding length.

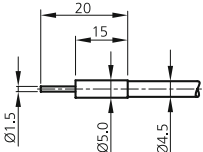
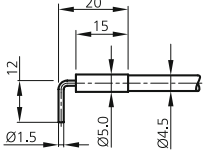
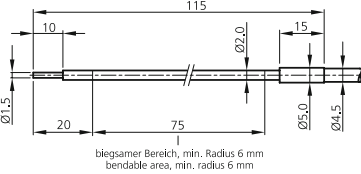
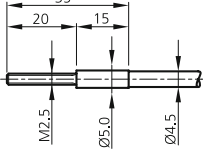
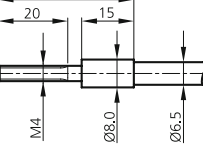
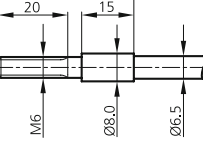
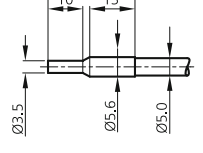
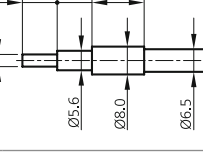
Glass fiber-optic sensors

	Glass fiber-optic cables Diffuse sensors	Fiber bundle	Scan width ³⁾ (mm)	Cable jacket	Cable length (mm)	Bending radius	Protection type	Product description
		Ø 1.0	up to 20	Silicone metal sleeve	300 600 1,000	> 3x tube Ø	IP 67	WRB 110 S-1.5-1.0 WRB 120 S-1.5-1.0 WRB 130 S-1.5-1.0
				metal sleeve	300 600 1,000	> 10x tube Ø		WRB 110 M-1.5-1.0 WRB 120 M-1.5-1.0 WRB 130 M-1.5-1.0
		Ø 1.0	up to 15	Silicone metal sleeve	300 600 1,000	> 3x tube Ø	IP 67	WRB 110 S-90-1.5-1.0 WRB 120 S-90-1.5-1.0 WRB 130 S-90-1.5-1.0
				metal sleeve	300 600 1,000	> 10x tube Ø		IP 60
 <small>biegsamer Bereich, min. Radius 6 mm bendable area, min. radius 6 mm</small>		Ø 1.0	up to 20	Silicone metal sleeve	300 600 1,000	> 3x tube Ø	IP 67	WRB 110 SB-2.0-1.0 WRB 120 SB-2.0-1.0 WRB 130 SB-2.0-1.0
				metal sleeve	300 600 1,000	> 10x tube Ø		IP 60
		Ø 1.5	up to 30	Silicone metal sleeve	300 600 1,000	> 3x tube Ø	IP 67	WRB 110 S-M2.5-1.5 WRB 120 S-M2.5-1.5 WRB 130 S-M2.5-1.5
				metal sleeve	300 600 1,000	> 10x tube Ø		IP 60
		Ø 2.5	up to 85	Silicone metal sleeve	300 600 1,000	> 3x tube Ø	IP 67	WRB 110 S-M4-2.5 WRB 120 S-M4-2.5 WRB 130 S-M4-2.5
				metal sleeve	300 600 1,000	> 10x tube Ø		IP 60
		Ø 2.5	up to 85	Silicone metal sleeve	300 600 1,000	> 3x tube Ø	IP 67	WRB 110 S-M6-2.5 WRB 120 S-M6-2.5 WRB 130 S-M6-2.5
				metal sleeve	300 600 1,000	> 10x tube Ø		IP 60
		Ø 2.5	up to 85	Polyurethane metal sleeve	300 600 1,000	> 5x tube Ø	IP 67	WRB 110 P-5.6-2.5 WRB 120 P-5.6-2.5 WRB 130 P-5.6-2.5
		Ø 2.5	up to 85	Silicone metal sleeve	300 600 1,000	> 3x tube Ø	IP 67	WRB 110 S-8.0-2.5 WRB 120 S-8.0-2.5 WRB 130 S-8.0-2.5
				metal sleeve	300 600 1,000	> 10x tube Ø		IP 60

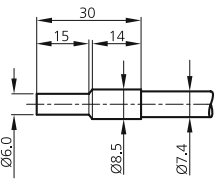
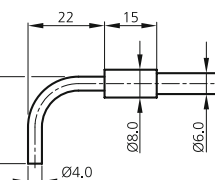
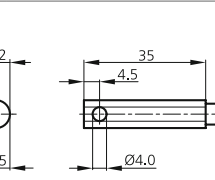
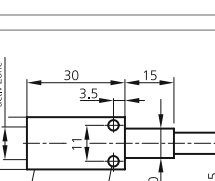
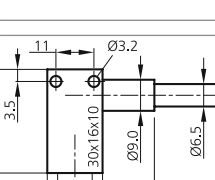
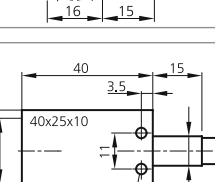
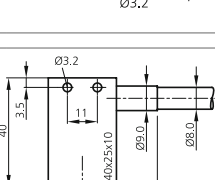
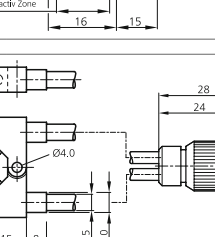
Installation instructions ^{1), 2)} and ³⁾ see page 51

	Glass fiber-optic cables Diffuse sensors	Fiber bundle	Scan width ³⁾ (mm)	Cable jacket	Cable length (mm)	Bending radius	Protection type	Product description
		Ø4.0	up to 150	Silicone metal sleeve	300 600 1,000	>3x tube Ø	IP 67	WRB 110 S-8.5-4.0 WRB 120 S-8.5-4.0 WRB 130 S-8.5-4.0
		Ø4.0	up to 150	metal sleeve	300 600 1,000	>10x tube Ø	IP 60	WRB 110 M-8.5-4.0 WRB 120 M-8.5-4.0 WRB 130 M-8.5-4.0
		Ø2.5	up to 80	Silicone metal sleeve	300 600 1,000	>3x tube Ø	IP 67	WRB 110 S-90-4.0-2.5 WRB 120 S-90-4.0-2.5 WRB 130 S-90-4.0-2.5
		Ø2.5	up to 80	metal sleeve	300 600 1,000	>10x tube Ø	IP 60	WRB 110 M-90-4.0-2.5 WRB 120 M-90-4.0-2.5 WRB 130 M-90-4.0-2.5
		Ø2.5	up to 70	Silicone metal sleeve	300 600 1,000	>3x tube Ø	IP 67	WRB 110 SR-8.0-2.5 WRB 120 SR-8.0-2.5 WRB 130 SR-8.0-2.5
		Ø2.5	up to 70	metal sleeve	300 600 1,000	>10x tube Ø	IP 60	WRB 110 MR-8.0-2.5 WRB 120 MR-8.0-2.5 WRB 130 MR-8.0-2.5
		Ø0.6 (10x) Ø0.3 (10x)	up to 90	Silicone metal sleeve	300 600 1,000	>3x tube Ø	IP 67	WRB 110 SQ-10-0.6 WRB 120 SQ-10-0.6 WRB 130 SQ-10-0.6
		Ø0.6 (10x) Ø0.3 (10x)	up to 90	metal sleeve	300 600 1,000	>10x tube Ø	IP 60	WRB 110 MQ-10-0.6 WRB 120 MQ-10-0.6 WRB 130 MQ-10-0.6
		Ø0.6 (10x) Ø0.3 (10x)	up to 85	Silicone metal sleeve	300 600 1,000	>3x tube Ø	IP 67	WRB 110 SQ-90-10-0.6 WRB 120 SQ-90-10-0.6 WRB 130 SQ-90-10-0.6
		Ø0.6 (10x) Ø0.3 (10x)	up to 85	metal sleeve	300 600 1,000	>10x tube Ø	IP 60	WRB 110 MQ-90-10-0.6 WRB 120 MQ-90-10-0.6 WRB 130 MQ-90-10-0.6
		Ø0.6 (20x) Ø0.3 (20x)	up to 210	Silicone metal sleeve	300 600 1,000	>3x tube Ø	IP 67	WRB 110 SQ-20-0.6 WRB 120 SQ-20-0.6 WRB 130 SQ-20-0.6
		Ø0.6 (20x) Ø0.3 (20x)	up to 210	metal sleeve	300 600 1,000	>10x tube Ø	IP 60	WRB 110 MQ-20-0.6 WRB 120 MQ-20-0.6 WRB 130 MQ-20-0.6
		Ø0.6 (20x) Ø0.3 (20x)	up to 200	Silicone metal sleeve	300 600 1,000	>3x tube Ø	IP 67	WRB 110 SQ-90-20-0.6 WRB 120 SQ-90-20-0.6 WRB 130 SQ-90-20-0.6
		Ø0.6 (20x) Ø0.3 (20x)	up to 200	metal sleeve	300 600 1,000	>10x tube Ø	IP 60	WRB 110 MQ-90-20-0.6 WRB 120 MQ-90-20-0.6 WRB 130 MQ-90-20-0.6
		Ø2.5	10-100	Silicone metal sleeve	300 600 1,000	>3x tube Ø	IP 67	WRB 220 SW

Installation instructions ^{1), 2)} and ³⁾ see page 51

Glass fiber-optic sensors

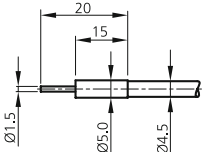
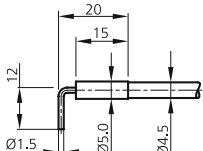
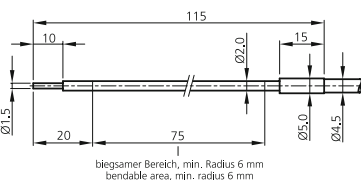
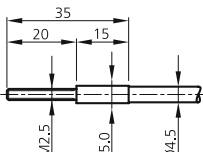
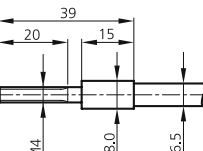
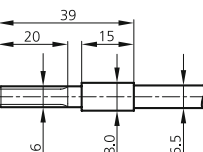
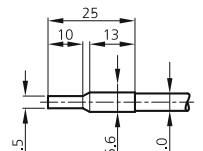
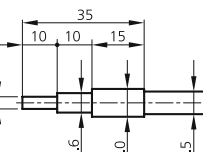
	Glass fiber-optic cables Through-beam sensors	Fiber bundle	Scan width ³⁾ (mm)	Cable jacket	Cable length (mm)	Bending radius	Protection type	Product description
		Ø1.0	up to 150	Silicone metal sleeve	300 600 1,000	>3x ¹⁾ tube Ø	IP 67	WRB 210 S-1.5-1.0 WRB 220 S-1.5-1.0 WRB 230 S-1.5-1.0
		Ø1.0	up to 150	metal sleeve	300 600 1,000	>10x ¹⁾ tube Ø	IP 60	WRB 210 M-1.5-1.0 WRB 220 M-1.5-1.0 WRB 230 M-1.5-1.0
		Ø1.0	up to 120	Silicone metal sleeve	300 600 1,000	>3x ¹⁾ tube Ø	IP 67	WRB 210 S-90-1.5-1.0 WRB 220 S-90-1.5-1.0 WRB 230 S-90-1.5-1.0
		Ø1.0	up to 120	metal sleeve	300 600 1,000	>10x ¹⁾ tube Ø	IP 60	WRB 210 M-90-1.5-1.0 WRB 220 M-90-1.5-1.0 WRB 230 M-90-1.5-1.0
		Ø1.0	up to 150	Silicone metal sleeve	300 600 1,000	>3x ¹⁾ tube Ø	IP 67	WRB 210 SB-2.0-1.0 WRB 220 SB-2.0-1.0 WRB 230 SB-2.0-1.0
		Ø1.0	up to 150	metal sleeve	300 600 1,000	>10x ¹⁾ tube Ø	IP 60	WRB 210 MB-2.0-1.0 WRB 220 MB-2.0-1.0 WRB 230 MB-2.0-1.0
		Ø1.5	up to 250 (500 ⁴⁾)	Silicone metal sleeve	300 600 1,000	>3x ¹⁾ tube Ø	IP 67	WRB 210 S-M2.5-1.5 WRB 220 S-M2.5-1.5 WRB 230 S-M2.5-1.5
		Ø1.5	up to 250 (500 ⁴⁾)	metal sleeve	300 600 1,000	>10x ¹⁾ tube Ø	IP 60	WRB 210 M-M2.5-1.5 WRB 220 M-M2.5-1.5 WRB 230 M-M2.5-1.5
		Ø2.5	up to 900 (1,800 ⁴⁾)	Silicone metal sleeve	300 600 1,000	>3x ¹⁾ tube Ø	IP 67	WRB 210 S-M4-2.5 WRB 220 S-M4-2.5 WRB 230 S-M4-2.5
		Ø2.5	up to 900 (1,800 ⁴⁾)	metal sleeve	300 600 1,000	>10x ¹⁾ tube Ø	IP 60	WRB 210 M-M4-2.5 WRB 220 M-M4-2.5 WRB 230 M-M4-2.5
		Ø2.5	up to 900	Silicone metal sleeve	300 600 1,000	>3x ¹⁾ tube Ø	IP 67	WRB 210 S-M6-2.5 WRB 220 S-M6-2.5 WRB 230 S-M6-2.5
		Ø2.5	up to 900	metal sleeve	300 600 1,000	>10x ¹⁾ tube Ø	IP 60	WRB 210 M-M6-2.5 WRB 220 M-M6-2.5 WRB 230 M-M6-2.5
		Ø2.5	up to 85	Polyurethane metal sleeve	300 600 1,000	>5x ¹⁾ tube Ø	IP 67	WRB 210 P-5.6-2.5 WRB 220 P-5.6-2.5 WRB 230 P-5.6-2.5
		Ø2.5	up to 85	Silicone metal sleeve	300 600 1,000	>3x ¹⁾ tube Ø	IP 67	WRB 210 S-8.0-2.5 WRB 220 S-8.0-2.5 WRB 230 S-8.0-2.5
		Ø2.5	up to 85	metal sleeve	300 600 1,000	>10x ¹⁾ tube Ø	IP 60	WRB 210 M-8.0-2.5 WRB 220 M-8.0-2.5 WRB 230 M-8.0-2.5

Installation instructions ^{1), 2)} and ³⁾ see page 51

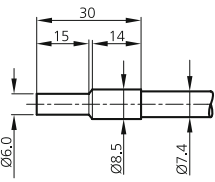
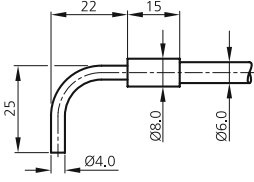
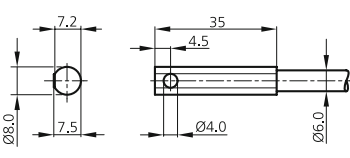
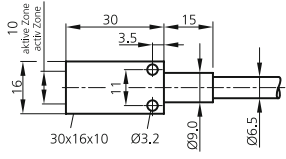
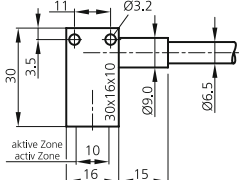
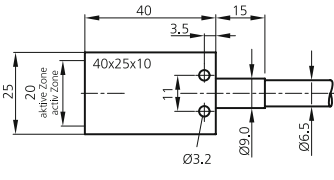
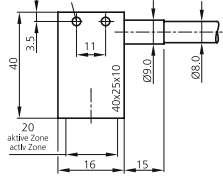
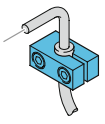
	Glass fiber-optic cables Through-beam sensors	Fiber bundle	Scan width ³⁾ (mm)	Cable jacket	Cable length (mm)	Bending radius	Protection type	Product description
		Ø4.0	up to 150	Silicone metal sleeve	300 600 1,000	>3x tube Ø	IP 67	WRB 210 S-8.5-4.0 WRB 220 S-8.5-4.0 WRB 230 S-8.5-4.0
		Ø4.0	up to 150	metal sleeve	300 600 1,000	>10x tube Ø	IP 60	WRB 210 M-8.5-4.0 WRB 220 M-8.5-4.0 WRB 230 M-8.5-4.0
		Ø2.5	up to 900	Silicone metal sleeve	300 600 1,000	>3x tube Ø	IP 67	WRB 210 S-90-4.0-2.5 WRB 220 S-90-4.0-2.5 WRB 230 S-90-4.0-2.5
		Ø2.5	up to 900	metal sleeve	300 600 1,000	>10x tube Ø	IP 60	WRB 210 M-90-4.0-2.5 WRB 220 M-90-4.0-2.5 WRB 230 M-90-4.0-2.5
		Ø2.5	up to 800	Silicone metal sleeve	300 600 1,000	>3x tube Ø	IP 67	WRB 210 SR-8.0-2.5 WRB 220 SR-8.0-2.5 WRB 230 SR-8.0-2.5
		Ø2.5	up to 800	metal sleeve	300 600 1,000	>10x tube Ø	IP 60	WRB 210 MR-8.0-2.5 WRB 220 MR-8.0-2.5 WRB 230 MR-8.0-2.5
		Ø0.6 (10x) Ø0.3 (10x)	up to 700	Silicone metal sleeve	300 600 1,000	>3x tube Ø	IP 67	WRB 210 SQ-10-0.3 WRB 220 SQ-10-0.3 WRB 230 SQ-10-0.3
		Ø0.6 (10x) Ø0.3 (10x)	up to 700	metal sleeve	300 600 1,000	>10x tube Ø	IP 60	WRB 210 MQ-10-0.3 WRB 220 MQ-10-0.3 WRB 230 MQ-10-0.3
		Ø0.6 (10x) Ø0.3 (10x)	up to 650	Silicone metal sleeve	300 600 1,000	>3x tube Ø	IP 67	WRB 210 SQ-90-10-0.3 WRB 220 SQ-90-10-0.3 WRB 230 SQ-90-10-0.3
		Ø0.6 (10x) Ø0.3 (10x)	up to 650	metal sleeve	300 600 1,000	>10x tube Ø	IP 60	WRB 210 MQ-90-10-0.3 WRB 220 MQ-90-10-0.3 WRB 230 MQ-90-10-0.3
		Ø0.6 (20x) Ø0.3 (20x)	up to 1,200	Silicone metal sleeve	300 600 1,000	>3x tube Ø	IP 67	WRB 210 SQ-20-0.3 WRB 220 SQ-20-0.3 WRB 230 SQ-20-0.3
		Ø0.6 (20x) Ø0.3 (20x)	up to 1,200	metal sleeve	300 600 1,000	>10x tube Ø	IP 60	WRB 220 MQ-20-0.3 WRB 230 MQ-20-0.3
		Ø0.6 (20x) Ø0.3 (20x)	up to 1,100	Silicone metal sleeve	300 600 1,000	>3x tube Ø	IP 67	WRB 210 SQ-90-20-0.3 WRB 220 SQ-90-20-0.3 WRB 230 SQ-90-20-0.3
		Ø0.6 (20x) Ø0.3 (20x)	up to 1,100	metal sleeve	300 600 1,000	>10x tube Ø	IP 60	WRB 210 MQ-90-20-0.3 WRB 220 MQ-90-20-0.3 WRB 230 MQ-90-20-0.3
	Accessories for fiber-optic cables							
	Accessories for fiber-optic cables; see the Accessories chapter							

Installation instructions ^{1), 2)} and ³⁾ see page 51

Light grids

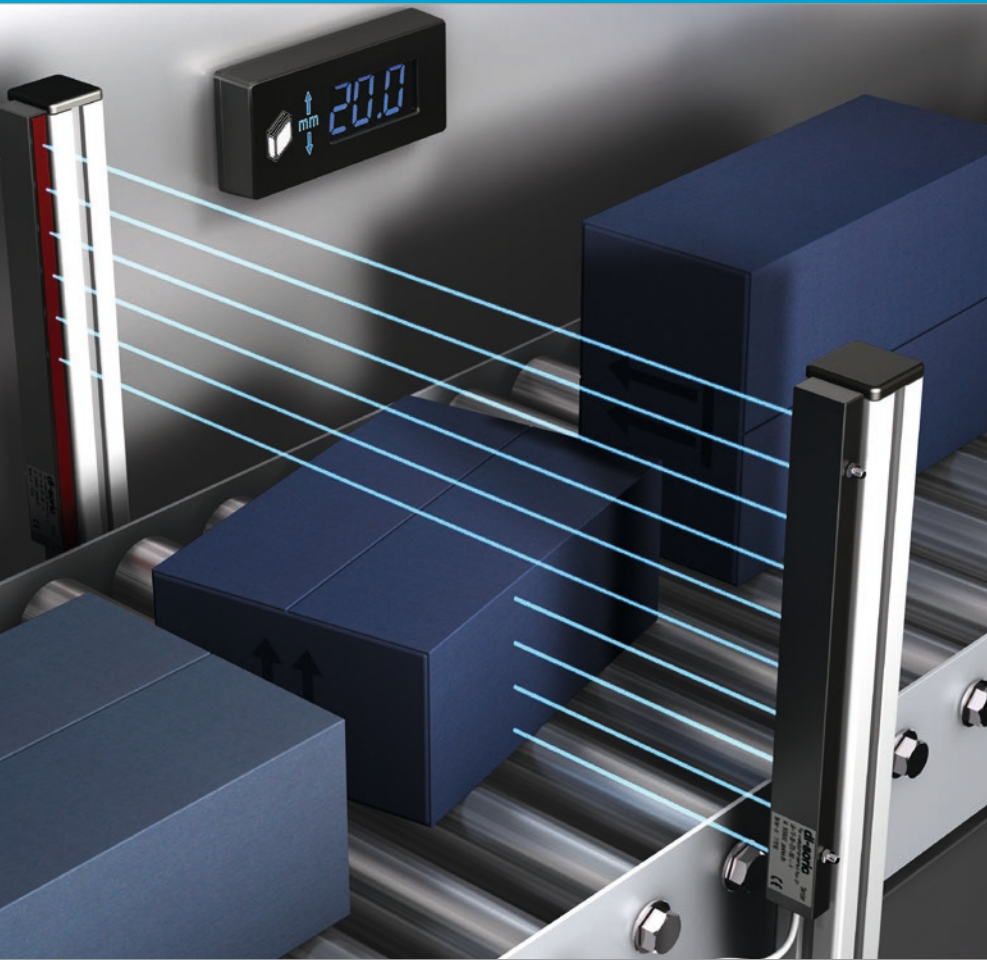

di-soric light grids monitor a defined control area with multiple invisible infrared light beams. The light grid systems operate on the principle of multiple through-beam sensors whose output signals are either interlinked (switching light grids) or evaluated individually (measuring light grids).

Each light grid system consists of a transmitter and receiver array made of anodized aluminum.

Depending on the light grid type, the evaluation electronics are integrated into the light grid array or act as an external amplifier in a separate housing.



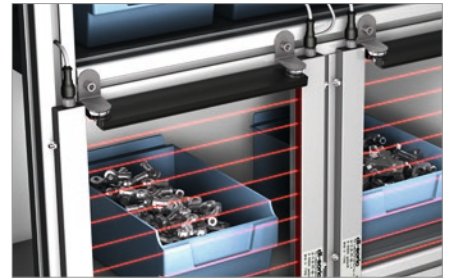
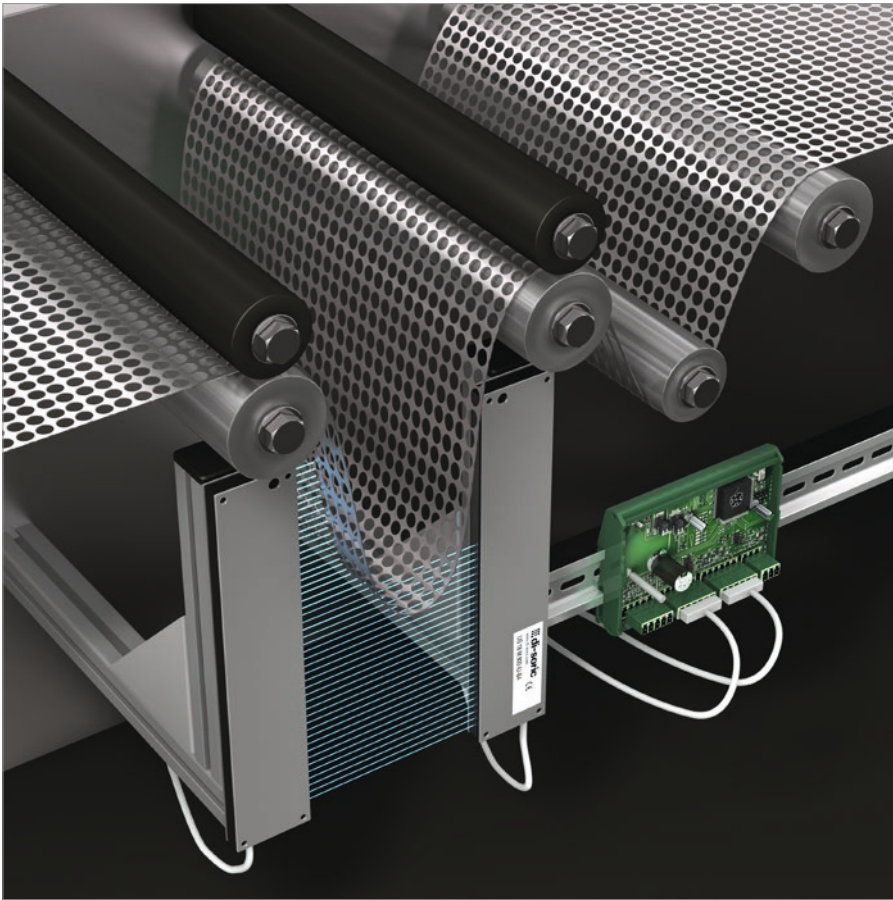

The low beam separation of 5 mm enables sag monitoring of very thin foils. Cut-outs in sheet metal can be reliably hidden using evaluation electronics.



Light grids with integrated electronics

Light grid LA... – horizontal beam evaluation

The various beam separations of 12.5 to 112 mm and the large selection in regard to the number of beams enable monitoring heights of 88 to 2.6 m.

The evaluation electronics are integrated into the receiver profile, which minimizes the wiring effort.

The transmitter and receiver array are optically synchronized by the first light beam. If necessary, failed or manipulated light beams can be hidden so that the light grid can continue to be operated in such cases.

In the standard profile variant I, multiple M4 x 10 threaded bolts are used for fastening. Profile variant Q is available as an option.

Light grid LA-D ... – diagonal beam evaluation

These light grids have the same functional range as the type LA..., but additional evaluation of the diagonal beams further improves the resolution in the middle between transmitter and receiver.

Light grid LA ... with integrated electronics

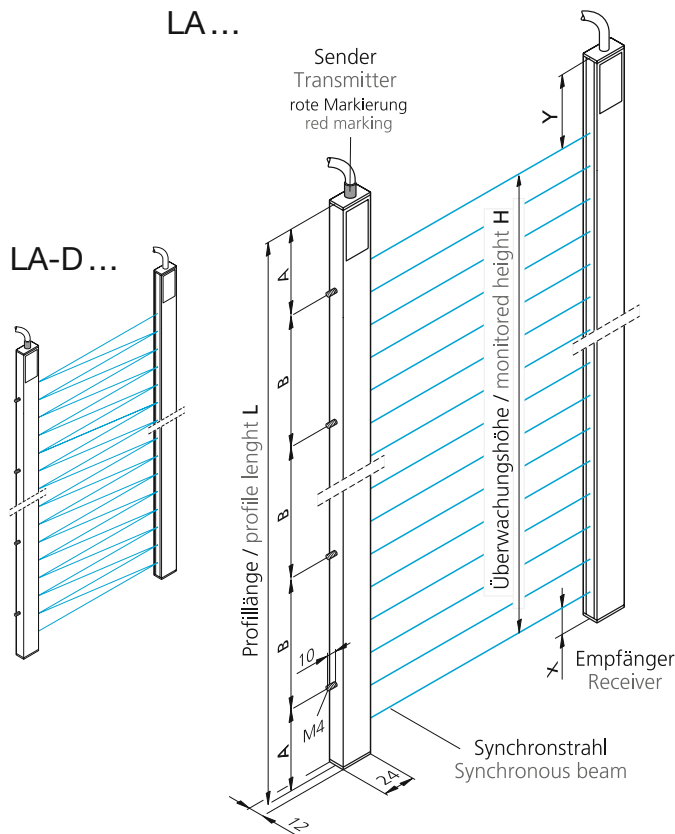

- Transistor outputs
- Alarm output in the event of contamination
- Beam separation 12.5 to 112 mm
- Monitoring heights up to 2,350 mm
- Compact design
- Aluminum housing
- Easy to install

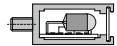
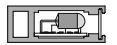

Profile cross sections	Design	Profile	Beam separation
	LA...I	12.5x24 mm (standard)	10 to 112 mm
	LA...Q	10x27 mm (on request)	10 to 112 mm (optionally available)





Technical data (typ.)				+20°C, 24 VDC			
Operating distance	0.7 to 4.0 m / set to 4.0 m at the factory			Outputs	Transistor pnp (switching output and alarm output)		
Number of beams	8 to 112			Current-carrying capacity	200 mA, short-circuit proof		
Beam separation	12.5/25/50/112 mm			Ambient temperature	-10 to +45 °C		
Monitoring height	88 to 2571 mm			Protection type	IP 54, optionally IP 65		
Emitted light	Infrared light, 880 nm, clocked			EMC directives	EN 61000-6-3:2001/EN 61000-6-1:2001		
Service voltage	20.4 to 28.8 V DC			Housing material	Aluminum bar profile		



Beam separation (mm)	Number of beams	Monitoring height H (mm)	Profile length L ca. (mm)	Design	Number of threaded bolts	Dimension A (mm)	Dimension B (mm)	Dimension X (mm)	Dimension Y (mm)	Light switching	Dark switching					
LA... / LA-D... integrated electronics											 Horizontal beam evaluation	 Diagonal beam evaluation				
12.5	8	88	260	I	2	30	200	13.5	153.5	■	■	LA 8-12.5-88-260 I-H	LA-D 8-12.5-88-260 I-H			
													■	■	LA 8-12.5-88-260 I-D	LA-D 8-12.5-88-260 I-D
	16	188	360		2	30	300			■	■	LA 16-12.5-188-360 I-H	LA-D 16-12.5-188-360 I-H			
										■	■	LA 16-12.5-188-360 I-D	LA-D 16-12.5-188-360 I-D			
	24	288	460		2	80	300			■	■	LA 24-12.5-288-460 I-H	LA-D 24-12.5-288-460 I-H			
										■	■	LA 24-12.5-288-460 I-D	LA-D 24-12.5-288-460 I-D			
	32	388	560		2	80	400			■	■	LA 32-12.5-388-560 I-H	LA-D 32-12.5-388-560 I-H			
										■	■	LA 32-12.5-388-560 I-D	LA-D 32-12.5-388-560 I-D			
	40	488	660		2	80	500			■	■	LA 40-12.5-488-660 I-H	LA-D 40-12.5-488-660 I-H			
										■	■	LA 40-12.5-488-660 I-D	LA-D 40-12.5-488-660 I-D			
	48	588	760		2	30	700			■	■	LA 48-12.5-588-760 I-H	LA-D 48-12.5-588-760 I-H			
										■	■	LA 48-12.5-588-760 I-D	LA-D 48-12.5-588-760 I-D			
	56	688	860		2	80	700			■	■	LA 56-12.5-688-860 I-H	LA-D 56-12.5-688-860 I-H			
										■	■	LA 56-12.5-688-860 I-D	LA-D 56-12.5-688-860 I-D			
64	788	960	3	80	400	■	■	LA 64-12.5-788-960 I-H	LA-D 64-12.5-788-960 I-H							
						■	■	LA 64-12.5-788-960 I-D	LA-D 64-12.5-788-960 I-D							
72	888	1,060	3	130	400	■	■	LA 72-12.5-888-1060 I-H								
						■	■	LA 72-12.5-888-1060 I-D								
80	988	1,160	3	80	500	■	■	LA 80-12.5-988-1160 I-H								
						■	■	LA 80-12.5-988-1160 I-D								
88	1,088	1,260	3	30	600	■	■	LA 88-12.5-1088-1260 I-H								
						■	■	LA 88-12.5-1088-1260 I-D								
96	1,188	1,360	3	80	600	■	■	LA 96-12.5-1188-1360 I-H								
						■	■	LA 96-12.5-1188-1360 I-D								
104	1,288	1,460	3	130	400	■	■	LA 104-12.5-1288-1460 I-H								
						■	■	LA 104-12.5-1288-1460 I-D								
112	1,388	1,560	4	30	500	■	■	LA 112-12.5-1388-1560 I-H								
						■	■	LA 112-12.5-1388-1560 I-D								

Light grids in housing design LA... Q are available on request!

Light grids with integrated electronics

Light grids LA... with integrated electronics

Beam separation (mm)	Number of beams	Monitoring height H (mm)	Profile length L ca. (mm)	Design	Number of threaded bolts	Dimension A (mm)	Dimension B (mm)	Dimension X (mm)	Dimension Y (mm)	Light switching	Dark switching				
LA... / LA-D... integrated electronics											 Horizontal beam evaluation	 Diagonal beam evaluation			
25	8	175	360	I	2	30	300	20	160	■	LA 8-25-175-360 I-H	LA-D 8-25-175-360 I-H			
													■	LA 8-25-175-360 I-D	LA-D 8-25-175-360 I-D
	16	375	560		2	80	400			■	LA 16-25-375-560 I-H	LA-D 16-25-375-560 I-H			
											■	LA 16-25-375-560 I-D	LA-D 16-25-375-560 I-D		
	24	575	760		2	30	700			■	LA 24-25-575-760 I-H	LA-D 24-25-575-760 I-H			
											■	LA 24-25-575-760 I-D	LA-D 24-25-575-760 I-D		
	32	775	960		3	80	400			■	LA 32-25-775-960 I-H	LA-D 32-25-775-960 I-H			
											■	LA 32-25-775-960 I-D	LA-D 32-25-775-960 I-D		
	40	975	1,160		3	80	500			■	LA 40-25-975-1160 I-H	LA-D 40-25-975-1160 I-H			
											■	LA 40-25-975-1160 I-D	LA-D 40-25-975-1160 I-D		
	48	1,175	1,360		3	80	600			■	LA 48-25-1175-1360 I-H	LA-D 48-25-1175-1360 I-H			
											■	LA 48-25-1175-1360 I-D	LA-D 48-25-1175-1360 I-D		
	56	1,375	1,560		4	80	500			■	LA 56-25-1375-1560 I-H	LA-D 56-25-1375-1560 I-H			
							■	LA 56-25-1375-1560 I-D	LA-D 56-25-1375-1560 I-D						
64	1,575	1,760	4	130	500	■	LA 64-25-1575-1760 I-H	LA-D 64-25-1575-1760 I-H							
							■	LA 64-25-1575-1760 I-D	LA-D 64-25-1575-1760 I-D						
72	1,775	1,960	4	80	600	■	LA 72-25-1775-1960 I-H								
							■	LA 72-25-1775-1960 I-D							
80	1,975	2,160	5	80	500	■	LA 80-25-1975-2160 I-H								
							■	LA 80-25-1975-2160 I-D							
88	2,175	2,360	5	140	520	■	LA 88-25-2175-2360 I-H								
							■	LA 88-25-2175-2360 I-D							
Light grids in housing design LA... Q are available on request!															

Beam separation (mm)	Number of beams	Monitoring height H (mm)	Profile length L ca. (mm)	Design	Number of threaded bolts	Dimension A (mm)	Dimension B (mm)	Dimension X (mm)	Dimension Y (mm)	Light switching	Dark switching				
LA... / LA-D... integrated electronics											 Horizontal beam evaluation	 Diagonal beam evaluation			
50	8	350	560	I	2	80	400	20	185	■		LA 8-50-350-560 I-H	LA-D 8-50-350-560 I-H		
												■		LA 8-50-350-560 I-D	LA-D 8-50-350-560 I-D
	16	750	960		3	80	400			■		LA 16-50-750-960 I-H	LA-D 16-50-750-960 I-H		
												■		LA 16-50-750-960 I-D	LA-D 16-50-750-960 I-D
	24	1,150	1,360		3	80	600			■		LA 24-50-1150-1360 I-H	LA-D 24-50-1150-1360 I-H		
												■		LA 24-50-1150-1360 I-D	LA-D 24-50-1150-1360 I-D
	32	1,550	1,760		4	130	500			■		LA 32-50-1550-1760 I-H	LA-D 32-50-1550-1760 I-H		
												■		LA 32-50-1550-1760 I-D	LA-D 32-50-1550-1760 I-D
	40	1,950	2,160	5	130	500	■		LA 40-50-1950-2160 I-H	LA-D 40-50-1950-2160 I-H					
									■		LA 40-50-1950-2160 I-D	LA-D 40-50-1950-2160 I-D			
	48	2,350	2,560	5	80	600	■		LA 48-50-2350-2560 I-H	LA-D 48-50-2350-2560 I-H					
										■		LA 48-50-2350-2560 I-D	LA-D 48-50-2350-2560 I-D		
Light grids in housing design LA... Q are available on request!															
112	8	783	1,050	I	3	125	400	20	245	■		LA 8-112-783-1050 I-H	LA-D 8-112-783-1050 I-H		
												■		LA 8-112-783-1050 I-D	LA-D 8-112-783-1050 I-D
	16	1,677	1,950		4	75	600			■		LA 16-112-1677-1950 I-H	LA-D 16-112-1677-1950 I-H		
												■		LA 16-112-1677-1950 I-D	LA-D 16-112-1677-1950 I-D
Light grids in housing design LA... Q are available on request!															

Light grids for operation with external electronics

Light grid LI... – for operation with external evaluation electronics LV...

Profile variant T, beam separation 5 mm (LI... T):

The monitoring range of these light grids extends from 35 to 1,715 mm.
The profile cross section of these light grids is 12x58 mm (LI... T);
M4 threaded holes on the side are used for mounting.

Profile variant I, beam separation 10 to 112 mm (LI... I):

Light grids with beam separations of 10 to 112 mm are found in the profile variant I (LI... I).
This profile features a very compact cross section of 12x24 mm; mounting is done
with M4 threaded bolts, the number of which is determined by the respective profile
length.

Optionally, light grids can be delivered with beam separations from 10 to 112 mm in
the profile variant LI... Q.

The profile cross section of this is 10x27 mm; holes drilled in the flat side with
a 4.5 mm diameter are used for mounting.

The transmitter and receiver array is connected to the external evaluation electronics
as standard by a 4-m-long connection cable with coded system plug connectors.
10m cable lengths and 0.75m pigtail variants with an M12 connector are optionally
available on request.



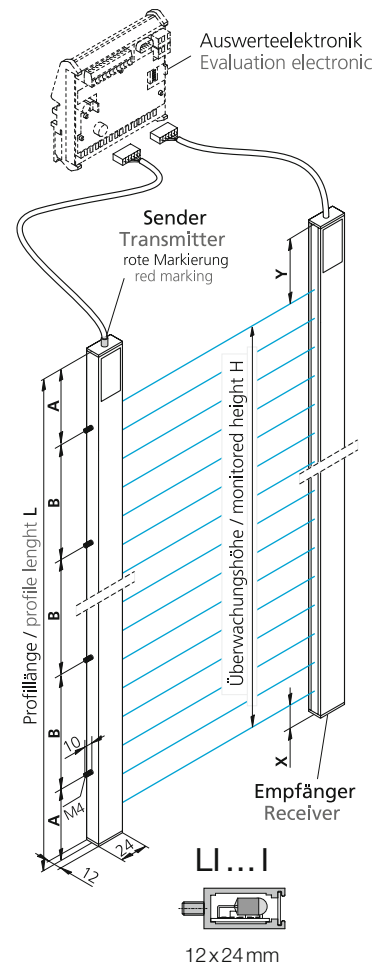
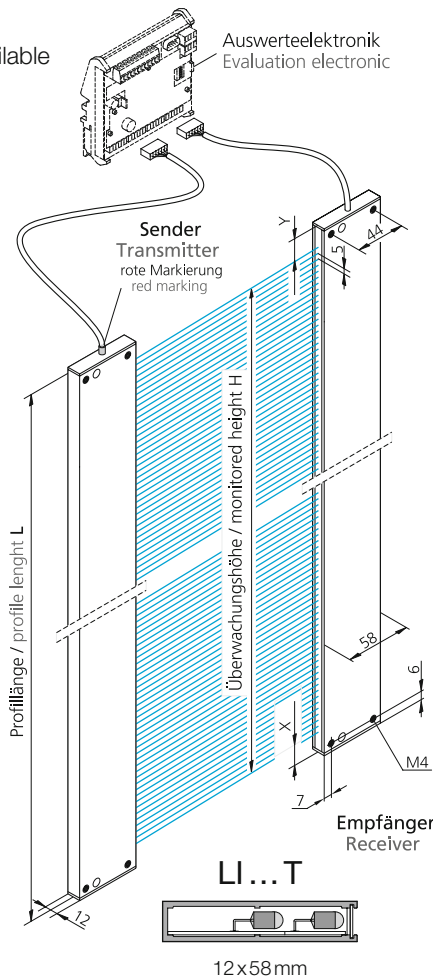

- For switching and measuring amplifiers
- Beam separations 5 to 112 mm
- Monitoring heights up to 2,375 mm
- Compact design
- Various profile cross sections are available
- Aluminum housing
- Easy to install





Light grid LI... for operation with evaluation electronics LVE... / LVX... or LVB...

Technical data (typ.)		+20 °C, 24 VDC	
Operating distance	0.25 to 6.0 m can be adjusted using the evaluation electronics		for evaluation electronics LVB... (switching)
Number of beams	8 to 344		for evaluation electronics LVE... / LVX... (measuring)
Beam separation	5/10/12.5/25/50/112 mm	Ambient temperature	-10 to +40 °C
Monitoring height	35 to 2375 mm	Protection type	IP 54, optionally IP 65
Emitted light	Infrared light, 880 nm		
Service voltage	-	Housing material	Aluminum bar profile



	Beam separation (mm)	Number of beams	Monitoring height H (mm)	Profile length L ca. (mm)	Design	Dimension X (mm)	Dimension Y (mm)		
	LI... T for operation with external evaluation electronics LVE... / LVX... or LVB...							Horizontal or diagonal beam evaluation	
	5		8	35	70	T	17.5	17.5	LI 8-5-35-70 T
			16	75	110				LI 16-5-75-110 T
			24	115	150				LI 24-5-115-150 T
			32	155	190				LI 32-5-155-190 T
			40	195	230				LI 40-5-195-230 T
			48	235	270				LI 48-5-235-270 T
			56	275	310				LI 56-5-275-310 T
			64	315	350				LI 64-5-315-350 T
			72	355	390				LI 72-5-355-390 T
			80	395	430				LI 80-5-395-430 T
			88	435	470				LI 88-5-435-470 T
			96	475	510				LI 96-5-475-510 T
			104	515	550				LI 104-5-515-550 T
			112	555	590				LI 112-5-555-590 T
			120	595	630				LI 120-5-595-630 T
			128	635	670				LI 128-5-635-670 T
			136	675	710				LI 136-5-675-710 T
			144	715	750				LI 144-5-715-750 T
			152	755	790				LI 152-5-755-790 T
			160	795	830				LI 160-5-795-830 T
			168	835	870				LI 168-5-835-870 T
			176	875	910				LI 176-5-875-910 T
			184	915	950				LI 184-5-915-950 T
			192	955	990				LI 192-5-955-990 T
			200	995	1,030				LI 200-5-995-1030 T
			208	1,035	1,070				LI 208-5-1035-1070 T
216	1,075	1,110	LI 216-5-1075-1110 T						
224	1,115	1,150	LI 224-5-1115-1150 T						
232	1,155	1,190	LI 232-5-1155-1190 T						
240	1,195	1,230	LI 240-5-1195-1230 T						
248	1,235	1,270	LI 248-5-1235-1270 T						
256	1,275	1,310	LI 256-5-1275-1310 T						
264	1,315	1,350	LI 264-5-1315-1350 T						
272	1,355	1,390	LI 272-5-1355-1390 T						
280	1,395	1,430	LI 280-5-1395-1430 T						
288	1,435	1,470	LI 288-5-1435-1470 T						
296	1,475	1,510	LI 296-5-1475-1510 T						
344	1,715	1,750	LI 344-5-1715-1750 T						

Light grids for operation with external electronics

Light grid LI... for operation with evaluation electronics LVE... / LVX... or LVB...

	Beam separation (mm)	Number of beams	Monitoring height H (mm)	Profile length L ca. (mm)	Design	Number of threaded bolts	Dimension A (mm)	Dimension B (mm)	Dimension X (mm)	Dimension Y (mm)	
											
 LI... I for operation with external evaluation electronics LVE... / LVX... or LVB...											
											Horizontal or diagonal beam evaluation
	10	8	70	130	I	2	20	90	13.5	38.5	LI 8-10-70-130 I
		16	150	210		2	55	100			LI 16-10-150-210 I
		24	230	290		2	45	200			LI 24-10-230-290 I
		32	310	370		2	35	300			LI 32-10-310-370 I
		40	390	450		2	75	300			LI 40-10-390-450 I
		48	470	530		2	65	400			LI 48-10-470-530 I
		56	550	610		2	105	400			LI 56-10-550-610 I
		64	630	690		2	45	600			LI 64-10-630-690 I
		72	710	770		2	35	700			LI 72-10-710-770 I
		80	790	850		2	75	700			LI 80-10-790-850 I
		88	870	930		2	65	800			LI 88-10-870-930 I
		96	950	1,010		3	105	400			LI 96-10-950-1010 I
		104	1,030	1,090		3	145	400			LI 104-10-1030-1090 I
		112	1,110	1,170		3	85	500			LI 112-10-1110-1170 I
		120	1,190	1,250		3	125	500			LI 120-10-1190-1250 I
		128	1,270	1,330		3	65	600			LI 128-10-1270-1330 I
		136	1,350	1,410		3	105	600			LI 136-10-1350-1410 I
		144	1,430	1,490		4	145	400			LI 144-10-1430-1490 I
	152	1,510	1,570	4	35	500	LI 152-10-1510-1570 I				
	160	1,590	1,650	4	75	500	LI 160-10-1590-1650 I				
¹⁾ Light grids with a larger monitoring height H (max. 196 beams) are available upon request!											
	12.5	8	88	140	I	2	25	90	13.5	38.5	LI 8-12.5-88-140 I
		16	188	240		2	70	100			LI 16 - 12.5-188-240 I
		24	288	340		2	70	200			LI 24-12.5-288-340 I
		32	388	440		2	70	300			LI 32-12.5-388-440 I
		40	488	540		2	70	400			LI 40-12.5-488-540 I
		48	588	640		2	70	500			LI 48-12.5-588-640 I
		56	688	740		2	70	600			LI 56-12.5-688-740 I
		64	788	840		2	70	700			LI 64-12.5-788-840 I
		72	888	940		2	70	800			LI 72-12.5-888-940 I
		80	988	1,040		3	120	400			LI 80-12.5-988-1040 I
		88	1,088	1,140		3	70	500			LI 88-12.5-1088-1140 I
		96	1,188	1,240		3	120	500			LI 96-12.5-1188-1240 I
		104	1,288	1,340		3	70	600			LI 104-12.5-1288-1340 I
		112	1,388	1,440		3	120	600			LI 112-12.5-1388-1440 I
		120	1,488	1,540		4	170	400			LI 120-12.5-1488-1540 I
		128	1,588	1,640		4	70	500			LI 128-12.5-1588-1640 I
		136	1,688	1,740		4	120	500			LI 136-12.5-1688-1740 I
		144	1,788	1,840		4	170	500			LI 144-12.5-1788-1840 I
¹⁾ Light grids with a larger monitoring height H (max. 196 beams) are available upon request!											

Light grid LI... for operation with evaluation electronics LVE... / LVX... or LVB...

	Beam separation (mm)	Number of beams	Monitoring height H (mm)	Profile length L ca. (mm)	Design	Number of threaded bolts	Dimension A (mm)	Dimension B (mm)	Dimension X (mm)	Dimension Y (mm)		
 LI... I for operation with external evaluation electronics LVE... / LVX... or LVB...											Horizontal or diagonal beam evaluation	
	25	8	175	240	I	2	70	100	20	45	LI 8-25-175-240 I	
		16	375	440		2	70	300			LI 16-25-375-440 I	
		24	575	640		2	70	500			LI 24-25-575-640 I	
		32	775	840		2	70	700			LI 32-25-775-840 I	
		40	975	1,040		3	120	400			LI 40-25-975-1040 I	
		48	1,175	1,240		3	125	500			LI 48-25-1175-1240 I	
		56	1,375	1,440		3	120	600			LI 56-25-1375-1440 I	
		64	1,575	1,640		4	70	500			LI 64-25-1575-1640 I	
		72	1,775	1,840		4	170	500			LI 72-25-1775-1840 I	
		80	1,975	2,040		4	120	600			LI 80-25-1975-2040 I	
		88	2,175	2,240		5	120	500			LI 88-25-2175-2240 I	
		96	2,375	2,440		5	165	520			LI 96-25-2375-2440 I	
	50	8	350	440	I	2	70	300	20	70	LI 8-50-350-440 I	
		16	750	840		2	70	700			LI 16-50-750-840 I	
		24	1,150	1,240		3	120	500			LI 24-50-1150-1240 I	
		32	1,550	1,640		4	70	500			LI 32-50-1550-1640 I	
		40	1,950	2,040		4	120	600			LI 40-50-1950-2040 I	
		48	2,350	2,440		5	180	520			LI 48-50-2350-2440 I	
	112	4	336	490	I	2	95	300	20	130	LI 4-112-336-490 I	
		8	783	940		2	70	800			LI 8-112-783-940 I	
		12	1,230	1,380		3	90	600			LI 12-112-1230-1380 I	
		16	1,677	1,830		4	165	500			LI 16-112-1677-1830 I	
		20	2,124	2,280		5	175	500			LI 20-112-2124-2280 I	
	Profile cross section LI...Q											
	 10x27mm	10	Light grids in housing design LI...Q are optionally available upon request									
		12.5										
		25										
		50										
		112										

Evaluation electronics for light grids of the series LI...



The combination of light grid LI... with evaluation electronics LVB... enables all the individual beams to be linked. If any light beam in the control area between the transmitter and receiver is interrupted, the output of the evaluation electronics switches immediately. The optimum operating distance is set using the integrated autocalibration. Fault evaluations are displayed by the signaling LEDs. The evaluation electronics LVB... are encased in a robust plastic housing.

Evaluation electronics LVB..., switching

- Evaluation electronics for 1 light grid LI...
- Relative switching threshold, thus very reliable object detection
- Increased safety: Safe shutoff if a contact gets jammed, no blanking in the event of errors
- 1 relay switching output
- High switching frequency
- Operating distance can be set by autocalibration



Technical data (typ.)	at +20 °C, 24 VDC		
Operating distance	0.4 to 6.0m, autocalibration	LED display	Status indicator/ error indicator
Number of beams	See Light grid LI...	Ambient temperature	0 to +40 °C
Switching capacity	250VDC, 250W 400V AC, 2000VA	Protection type	IP 54
Output function	Light switching	Protection class	III, operation on protective low voltage
Beam evaluation	Multiplexing	EMC directives	EN 61000-6-1: 2001
Cycle time per light beam	starting at 0.08 ms/beam (depending on operating distance)		EN 61000-6-3: 2001
Switching frequency	10Hz	Housing material	ABS gray

	Number of light grids to be operated	Switching output (relay 10Hz)	Analog outputs	Service voltage (VDC)	Profibus interface D-Sub, 9-pin (address can be adjusted)	Ethernet / IP	Profinet	Dimensions L x W x H (mm)	
Evaluation electronics LVB..., switching									Product description
	1	1		19 to 30				57.5 x 120 x 200	LVB-24VDC
	1	1		230 (+5/-10%)				57.5 x 120 x 200	LVB-230VAC

One light grid pair can be connected to the LVE evaluation unit; up to two light grid pairs of the LI... series can be connected to the LVX variant. Thanks to the integrated RS232 interface, freely configurable functions are possible; for example, a resolution of 2.5 mm can be achieved for a light grid pair LI...T using diagonal beam evaluation. Expansion modules for Profibus, Profinet, Ethernet-IP, analog outputs, LED display panels and additional switching outputs are optionally available.

Thanks to the evaluation electronics being configured to the respective customer requirements at the factory and to the integrated autocalibration through DIP switches, the start-up time can be reduced to a minimum. LVE / LVX is mounted on a standard top-hat rail.

Evaluation electronics LVE... / LVX..., measuring

- Evaluation electronics for 1 or 2 light grids LI ...
- Interfaces: 1x configurable input,
- 3x combined inputs/outputs, 3x outputs, RS232, CANopen, Profibus, Profinet, Ethernet/IP
- Modular system
- Diagnosis LEDs
- Freely configurable functions



Technical data (typ.)		at +20 °C, 24 VDC	
Operating distance	0.25 to 6.0m, adjustable	LED display	Error indicator
Number of beams	max. 500	Ambient temperature	0 to +40 °C
Service voltage	20 to 26 V DC	Protection type	IP 00
Outputs	See the graphic above		IP 65 with optional outer housing
Switching capacity	250mA	Protection class	III, operation on protective low voltage
Output function	Configurable	EMC directives	EN 61000-6-1: 2001
beam evaluation	Parameters can be configured horizontally / diagonally		EN 61000-6-3: 2001
Cycle time per light beam	0.05 ms (depends on configuration)	Housing material	Plastic
	and operating distance of the light grid arrays		

Evaluation electronics LVE... / LVX..., measuring												Product description														
Number of light grids to be operated		Configurable inputs (24 VDC, 12mA, 3,000Hz)		Outputs (24 VDC, 0.25A, PNP)		Analog outputs (0 to 10V)		3 combined IOs		RS 232		Configuration by means of DIP series		CANopen interface		Profibus interface D-Sub, 9-pin (address can be adjusted)		Ethernet / IP		Profinet		Dimensions L x W x H (mm)				
1	1	1																					88 x 126 x 60	LVE ¹⁾		
		1																						163 x 126 x 60	LVE-PBI ¹⁾	
		1																						130 x 126 x 60	LVE-ENI ¹⁾	
		1																						163 x 126 x 60	LVE-PNI ¹⁾	
		1	2																						124 x 126 x 60	LVE-ALX ¹⁾
		17																							147 x 126 x 60	LVE-016 ¹⁾
2	1	3																						125 x 126 x 60	LVX ¹⁾	
		3																						200 x 126 x 60	LVX-PBI ¹⁾	
		3																						200 x 126 x 60	LVX-PNI ¹⁾	
		3	2																					161 x 126 x 60	LVX-ALX ¹⁾	
		19																							184 x 126 x 60	LVX-016 ¹⁾

¹⁾ The evaluation electronics are configured at the factory using the customer's application.



Color sensors

These quality sensors detect nuances in a change in color or surface structure and are often used for quality checks.

- Perceptive method (based on perception)
- Measurement in colorimetric color spaces such as L*a*b and L*u*v
- Differentiation of very small shades of color ($\Delta E < 1$)
- Up to 350 channels
- 2-channel differential evaluation
- Adjustable color tolerance
- Very short response time
- High ambient light immunity
- Reflection compensation
- Measured values for computer applications (.xls, .csv) exportable
- Extensive options for using a computer to configure settings
- Control of the surface structure
- Separate evaluation of brightness and color value
- Lighting with aging-compensated white-light LED
- Key lock function
- Fixed optics or fiber-optic cable adaptation
- Fiber-optic cable with various attachment optics
- Visualization of the color values with computer software
- FS software is included in the scope of delivery







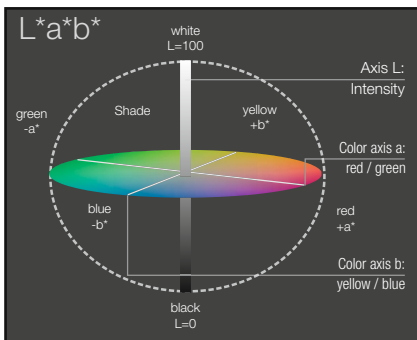

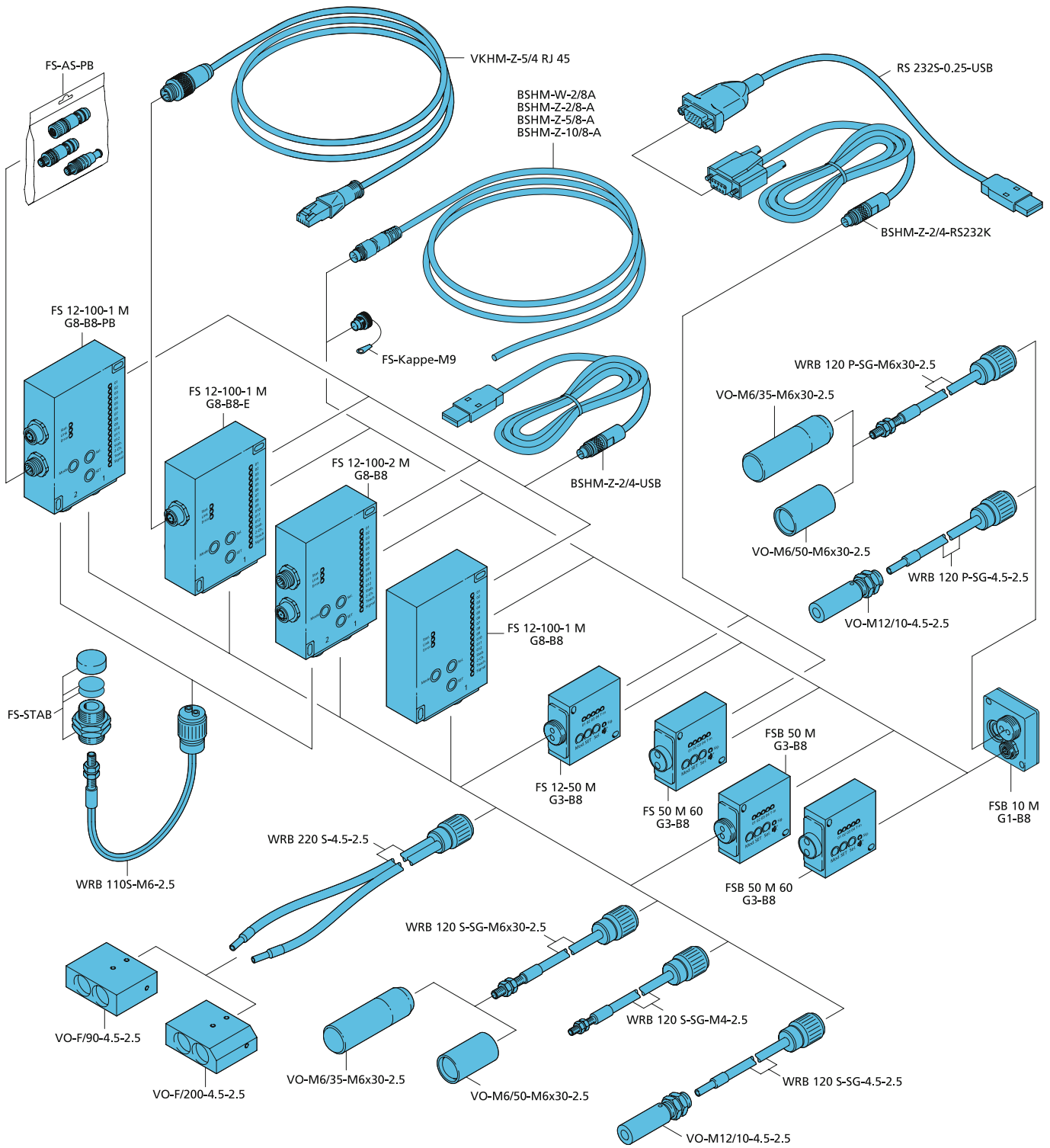

Technical data (typ.)	+20°C, 24 VDC
Emitting light source	White-light LED, can be turned off
Color resolution	DE Lab < 1
Activation time / scanning frequency	0.2 ms 5,000Hz: up to 350 colors can be evaluated
	0.1 ms 10,000Hz: up to 30 colors can be evaluated
	0.05 ms 20,000Hz: 3 colors can be evaluated
	0.5 ms Off-Delay / -
No-load current	80 mA (24 V DC)
Protection type	IP 54
	IP 67 (FSB 10...)

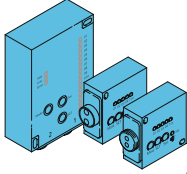
	Operating distance (mm)	Measuring channels (number)	Number of color channels (Teach-in via button)	Number of outputs npn + pnp (push-pull)	Service voltage (VDC)	Color memory internal	Operation using software	Operation using buttons	Color channels with binary coding (number)	Fiber-optic cable adapter	Fixed optics	Lighting with aging-compensating white-light LED	Profibus	Ethernet	Product description
	See fiber-optic cables	1	1	1	10 to 28	1	■		■		■				FSB 10 M G1-B8
	See fiber-optic cables	1	4	4	18 to 28	4	■		■		■				FSB 50 M G3-B8
	30 to 60									■	■				FSB 50 M 60 G3-B8
	See fiber-optic cables	1	4	4	18 to 28	100	■	■	15	■		■			FS 12-50 M G3-B8
	30 to 60									■	■				FS 50 M 60 G3-B8
	See fiber-optic cables	1	12	12	18 to 28	100	■	■	100	■		■			FS 12-100-1 M G8-B8
										■			■		FS 12-100-1 M G8-B8-E
										■					FS 12-100-1 M G8-B8-E
	See fiber-optic cables	2	12	12	18 to 28	100	■	■	100	■		■			FS 12-100-2 M G8-B8
										■		■			FS 12-100-2 M G8-B8-PB

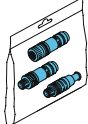

Overview of components and matching accessories

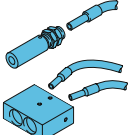
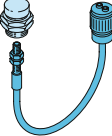

											Connections	Cable length (m)	Protection type	
FSB 10 M G1-B8 FSB 50 M 60 G3-B8 FSB 50 M G3-B8 FS 50 M 60 G3-B8 FS 50 M G3-B8 FS 12-100-1 M G3-B8 FS 12-100-1 M G3-B8-E FS 12-100-2 M G3-B8 FS 12-100-2 M G3-B8-PB														
Connection cable											Product description			
	■	■	■	■	■	■	■	■	■	■	Angled M9 connector, 8-pin / flying leads	2.0	IP 67	BSHM-W-2/8A
	■	■	■	■	■	■	■	■	■	■	Straight connector M9, 8-pin / flying leads	2.0	IP 67	BSHM-Z-2/8A
	■	■	■	■	■	■	■	■	■	■		5.0	IP 67	BSHM-Z-5/8A
	■	■	■	■	■	■	■	■	■	■		10.0	IP 67	BSHM-Z-10/8A
Connection cable for computer, connection set for Profibus / Ethernet														
				■	■	■	■	■	■	■	computer / RS 232	2.0		BSHM-Z-2/4-RS232K
						■	■	■	■		computer / USB	2.0		BSHM-Z-2/4-USB
								■			computer / Ethernet	5.0		VKHM-Z-5/4-RJ45
										■	computer / Profibus	M12, B-coded		FS-AS-PB
Adapter RS232 / USB														
				■	■	■	■	■	■	■	USB / RS 232	0.25		RS232S-0.25-USB
Cover for M9 sockets (USB / RS232, for two or more sockets)														
				■	■	■	■	■	■	■				FS-Kappe-M9
Fiber-optic cables / focus optics														
	■		■		■	■	■	■	■					Articles, see pages 72 to 73
Stabilization system														
								■	■			0.3	IP 67	WRB 110 S-M6-2.5
								■	■					FS-STAB

Fiber-optic cables / focus optics

Glass fiber-optic cables feature high temperature resistance and a robust design.

One- or two-armed fiber-optic cables with different sensor probes are available.

Focus optics focus the light beam down to a small measuring spot diameter, enabling color measurement on very small surfaces.

The operating range of the focus optics is 10 to 300mm.

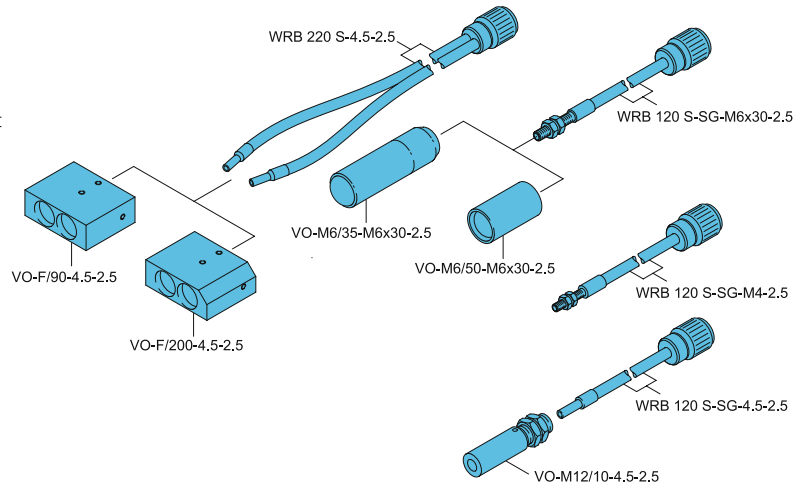

Focus optics

for operation with 1-arm fiber

VO-M12/10-4.5-2.5	VO-M6/35-M6x30-2.5	VO-M6/50-M6x30-2.5

for operation with 2-arm fiber









VO-F/90-4.5-2.5	VO-F/200-4.5-2.5

mm (typ.)

Technical data (typ.)

Fiber-optic cable	WRB 120 S-SG ... / WRB 220 S-4.5-2.5	WRB 120 P-SG ...
Active Ø	Ø 2.5mm	Ø 2.5mm
Protection type	IP 67	IP 67
Bending radius	≥ 3 x tube Ø	≥ 2 x tube Ø
Material of sensor probe	VA	VA
Material of fibers	Glass fibers	Glass fibers
Material of sheathing	Silicone-metal sleeve	PVC
Length of fiber-optic cable	600mm	600mm

Focus optics	VO ...
Fiber bundle	Ø 2.5mm
Material of focus optics	Aluminum, anodized

		FSB 10 M G1-B8	FSB 50 M G3-B8	FS 50 M G3-B8	FS 12-100-1 M G3-B8	FS 12-100-2 M G3-B8 / ... G3-B8-PB	Fastening for fiber-optic cable / focus optics	Measuring spot Ø (mm)	Working distance (mm)	Length (mm)	Single fiber (mm)	Operating range (mm)	Opening angle	Temperature resistance (°C)	
		Fiber optics and matching focus optics												Product description	
	Fiber optic cable:	■	■	■	■	■	Ø4.5			600	0.05 ¹⁾		67°	-40 to +180	WRB 120 S-SG-4.5-2.5
	Fiber optic cable:	■					Ø4.5			600			68°	+80	WRB 120 P-SG-4.5-2.5
	Focus optics	■	■	■	■	■	Ø4.5	2.0	10			10 to 15			VO-M12/10-4.5-2.5
	Fiber optic cable:		■	■	■	■	M4			600			67°	-40 to +180	WRB 120 S-SG-M4-2.5
	Fiber optic cable:		■	■	■	■	M6			600	0.05 ¹⁾		67°	-40 to +180	WRB 120 S-SG-M6x30-2.5
	Fiber optic cable:	■					M6			600			68°	+80	WRB 120 P-SG-M6x30-2.5
	Focus optics	■	■	■	■	■	M6	6.0	35			30 to 60			VO-M6/35-M6x30-2.5
	Focus optics	■	■	■	■	■	M6	6.0	50			35 to 60			VO-M6/50-M6x30-2.5
  	Fiber optic cable:		■	■	■	■	Ø4.5			600	0.05		67°	-40 to +180	WRB 220 S-4.5-2.5
	Focus optics		■	■	■	■	Ø4.5	14	90			70 to 150			VO-F/90-4.5-2.5
	Focus optics		■	■	■	■	Ø4.5	20	200			150 to 300			VO-F/200-4.5-2.5

¹⁾ Fiber arrangement statistically mixed

Ring and wire-break sensors



Inductive ring and wire-break sensors are available with static or dynamic evaluation for various ring diameters.

The very high detection sensitivity enables detection of metal parts with very low mass at a very high part speed.

There are various fastening options and accessories available for easy integration into machines and systems. A special shield enables multiple sensors to be lined up without impacting one another. Both the sensitivity and the pulse stretching can be adapted to the requirements of the application.



Inductive ring sensors with static evaluation IRB ...



- Quick commissioning, no setting elements
- Static operating principle
- No risk of incorrect adjustments
- Short activation time
- Ring diameter 10 to 27 mm



Inductive ring sensors with static evaluation IRB ... have no setting elements, so they are quickly put into operation and are ready for most application areas straight out of the box

Technical data (typ.)	+20 °C, 24 VDC
Service voltage	10 to 35 V DC
Voltage drop	2.0 V
Speed of parts	< 35 m/s
Ambient temperature	-25 to 70 °C
Protection type	IP 67
Insulation voltage endurance	1,000 V
Housing material	Polyamide, ring POM

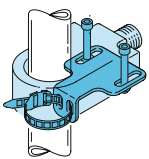

Ring diameter (mm)	Evaluation: Static (S)	No-load current (mA)	Resolution, steel ball (mm)	Switching output	Pulse stretching (ms)	Cable length, Plug connector	Connection cable (optionally available)	
Inductive ring sensors, basic								
	10.1	T	11	2.0	pnp, 200 mA, NO	150	M12	VK ...
					npn, 200 mA, NO			IRB 10 PS-B3 IRB 10 NS-B3
	15.1	T	11	2.5	pnp, 200 mA, NO	150	M12	VK ...
					npn, 200 mA, NO			IRB 15 PS-B3 IRB 15 NS-B3
	20.1	T	11	3.0	pnp, 200 mA, NO	150	M12	VK ...
					npn, 200 mA, NO			IRB 20 PS-B3 IRB 20 NS-B3
	27.1	T	11	4.0	pnp, 200 mA, NO	150	M12	VK ...
								IRB 27 PS-B3

Mounting angle for ring sensors IRB 6-27	Product description
	BWS-IR01

Ring and wire-break sensors

Inductive ring sensors with static evaluation IR...

- High resolution
- Static operating principle
- Sensitivity adjustment
- Short activation time
- Pulse stretching adjustable
- NO/NC function, switchable











Inductive ring sensors with static evaluation are used for detecting and counting parts. The static evaluation principle enables a simple accumulation monitoring to be implemented.

Technical data (typ.)	+20 °C, 24 VDC
Service voltage	10 to 35 V DC
Sensitivity adjustment	Potentiometer
Voltage drop	2.0 V
Speed of parts	< 35 m/s
Ambient temperature	-25 to 70 °C
Protection type	IP 67
Insulation voltage endurance	1,000V
Housing material	Polyamide, ring POM
	Die-cast aluminum, ring POM (only IR 150...)

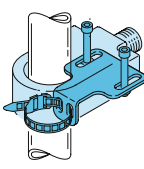

	Ring diameter (mm)	Evaluation: Static (S) / Dynamic (D)	No-load current (mA)	Resolution, steel ball (mm)	Switching output	Pulse stretching (ms)	Cable length, Plug connector	Connection cable (optionally available)	
Inductive ring sensors, static evaluation									Product description
	6.1	T	11	1.0	pnp, 200 mA, NO/NC	10 to 150	M12	VK ...	IR 6 PSOK-IBS
					npn, 200 mA, NO/NC		IR 6 NSOK-IBS		
					pnp, 200 mA, NO/NC		0.3m/M12		IR 6 PSOK-K-BS
	10.1	T	11	1.5	pnp, 200 mA, NO/NC	10 to 150	M12	VK ...	IR 10 PSOK-IBS
					npn, 200 mA, NO/NC		IR 10 NSOK-IBS		
					pnp, 200 mA, NO/NC		0.3m/M12		IR 10 PSOK-K-BS
	15.1	T	11	2.0	pnp, 200 mA, NO/NC	10 to 150	M12	VK ...	IR 15 PSOK-IBS
					npn, 200 mA, NO/NC		IR 15 NSOK-IBS		
					pnp, 200 mA, NO/NC		0.3m/M12		IR 15 PSOK-K-BS

	Ring diameter (mm)	Evaluation: Static (S) / Dynamic (D)	No-load current (mA)	Resolution, steel ball (mm)	Switching output	Pulse stretching (ms)	Cable length, Plug connector	Connection cable (optionally available)	
Inductive ring sensors, static evaluation									Product description
	20.1	T	11	2.5	pnp, 200 mA, NO/NC	10 to 150	M12	VK ...	IR 20 PSOK-IBS
					npn, 200 mA, NO/NC		0.3m/M12		IR 20 NSOK-IBS
	20.1	T	11	2.5	pnp, 200 mA, NO/NC	10 to 150	M12	VK ...	IR 20 PSOK-K-BS
					npn, 200 mA, NO/NC		0.3m/M12		IR 20 NSOK-K-BS
	25.1	T	11	3.0	pnp, 200 mA, NO/NC	10 to 150	M12	VK ...	IR 25 PSOK-IBS
					npn, 200 mA, NO/NC		0.3m/M12		IR 25 NSOK-IBS
	25.1	T	11	3.0	pnp, 200 mA, NO/NC	10 to 150	M12	VK ...	IR 25 PSOK-K-BS
					npn, 200 mA, NO/NC		0.3m/M12		IR 25 NSOK-K-BS
	35.2	T	11	4.5	pnp, 200 mA, NO/NC	10 to 150	M12	VK ...	IR 35 PSOK-IBS
					npn, 200 mA, NO/NC		M12		IR 35 NSOK-IBS
	51.0	T	11	6.0	pnp, 200 mA, NO/NC	10 to 150	M12	VK ...	IR 50 PSOK-IBS
					npn, 200 mA, NO/NC		M12		IR 50 NSOK-IBS
	101.0	T	15	10.0	pnp, 200 mA, NO/NC	10 to 150	M12	VK ...	IR 100 PSOK-IBS
					npn, 200 mA, NO/NC		M12		IR 100 NSOK-IBS
	151.0	T	15	19.0	pnp, 200 mA, NO/NC	10 to 150	M12	VK ...	IR 150 PSOK-IBS
					npn, 200 mA, NO/NC		M12		IR 150 NSOK-IBS
Mounting angle for ring sensors IR 6-25									Product description
									
									BWS-IR01

Ring and wire-break sensors

Inductive ring sensors with dynamic evaluation IRD...

- High resolution
- Dynamic operating principle
- Sensitivity adjustment
- Short activation time
- Pulse stretching adjustable
- NO/NC function, switchable
- Insensitive to dirt



Ring sensors with dynamic evaluation have a higher resolution than ring sensors with static resolution, so they are particularly suited for detecting very small parts with a low mass. The dynamic operating principle independently compensates for contamination in the supply tube.

Technical data (typ.)	+20 °C, 24 VDC
Service voltage	10 to 35 V DC
Sensitivity adjustment	Potentiometer
Voltage drop	2.0V
Speed of parts	<35 m/s
Ambient temperature	-25 to 70 °C
Protection type	IP 67
Insulation voltage endurance	1,000V
Housing material	Polyamide, ring POM
	Die-cast aluminum, ring POM (only IRD 150...)



	Ring diameter (mm)	Evaluation: Static (S) / Dynamic (D)	No-load current (mA)	Resolution, steel ball (mm)	Switching output	Pulse stretching (ms)	Cable length Plug connector	Connector cable (optionally available)	Product description
	6.1	D	<20	0.5	pnp, 200 mA, NO/NC	0.1 to 150	M12	VK ...	IRD 6 PSOK-IBS
					npn, 200 mA, NO/NC				IRD 6 NSOK-IBS
	10.1	D	<20	0.6	pnp, 200 mA, NO/NC	0.1 to 150	M12	VK ...	IRD 10 PSOK-IBS
					npn, 200 mA, NO/NC				IRD 10 NSOK-IBS
	15.1	D	<20	0.8	pnp, 200 mA, NO/NC	0.1 to 150	M12	VK ...	IRD 15 PSOK-IBS
					npn, 200 mA, NO/NC		300, M12		IRD 15 NSOK-IBS
					pnp, 200 mA, NO/NC				IRD 15 PSOK-K-BS
	20.1	D	<20	1.0	pnp, 200 mA, NO/NC	0.1 to 150	M12	VK ...	IRD 20 PSOK-IBS
					npn, 200 mA, NO/NC		300, M12		IRD 20 NSOK-IBS
					pnp, 200 mA, NO/NC				IRD 20 PSOK-K-BS
	25.1	D	<20	1.2	pnp, 200 mA, NO/NC	0.1 to 150	M12	VK ...	IRD 25 PSOK-IBS
					npn, 200 mA, NO/NC		300, M12		IRD 25 NSOK-IBS
					pnp, 200 mA, NO/NC				IRD 25 PSOK-K-BS
	35.2	D	<20	2.0	pnp, 200 mA, NO/NC	0.1 to 150	M12	VK ...	IRD 35 PSOK-IBS
					npn, 200 mA, NO/NC				IRD 35 NSOK-IBS
	51.0	D	<20	2.5	pnp, 200 mA, NO/NC	0.1 to 150	M12	VK ...	IRD 50 PSOK-IBS
					npn, 200 mA, NO/NC				IRD 50 NSOK-IBS

Inductive ring sensors with dynamic evaluation IRD...

	Ring diameter (mm)	Evaluation: Static (S) / Dynamic (D)	No-load current (mA)	Resolution, steel ball (mm)	Switching output	Pulse stretching (ms)	Cable length, Plug connector	Connection cable (optionally available)	
	101.0	D	<20	5.0	pnp, 200 mA, NO/NC	0.1 to 150	M12	VK ...	IRD 100 PSOK-IBS
					npn, 200 mA, NO/NC				IRD 100 NSOK-IBS
	151.0	D	<20	10.0	pnp, 200 mA, NO/NC	0.1 to 150	M12	VK ...	IRD 150 PSOK-IBS
					npn, 200 mA, NO/NC				IRD 150 NSOK-IBS

Wire-break sensors with static/dynamic evaluation

- Particularly high resolution
- Static or dynamic operating principle
- Sensitivity adjustment
- Short activation time
- Pulse stretching adjustable
- NO/NC function, switchable
- Ring diameters 4 and 6.1 mm
- Insensitive to dirt



Wire-break sensors with particularly high resolution are available in static and dynamic versions. The static version detects very thin wires made of various alloys that are fed through the detection field. Wire-break sensors in the dynamic version are used for detecting very small wire movements. Thus, for example, a wire break is reliably detected even if the wire stays in the detection field.

Technical data (typ.)	+20 °C, 24 VDC
Service voltage	10 to 35 V DC
Sensitivity adjustment	Potentiometer
Voltage drop	2.0 V
Speed of parts	< 35 m/s
Ambient temperature	-25 to 70 °C
Protection type	IP 67
Insulation voltage endurance	1,000 V
Housing material	Polyamide, ring POM, ceramic insert (IRDBx 4...) Polyamide, ring POM (IRDBx 6...)



	Ring diameter (mm)	Evaluation: Static (S) / Dynamic (D)	No-load current (mA)	Resolution, Cu wire (mm)	Switching output	Pulse stretching (ms)	Cable length, Plug connector	Connection cable (optionally available)	
Wire-break sensors									Product description
	4.0	T	11	0.2	pnp, 200 mA, NO	10 to 150	M12	VK ...	IRDB 4 PSOK-IBS
		D	<20	0.1	npn, 200 mA, NO				IRDB 4 NSOK-IBS
	6.1	T	11	0.2	pnp, 200 mA, NO	10 to 150	M12	VK ...	IRDB 6 PSOK-IBS
		D	<20	0.1	npn, 200 mA, NO				IRDB 6 NSOK-IBS

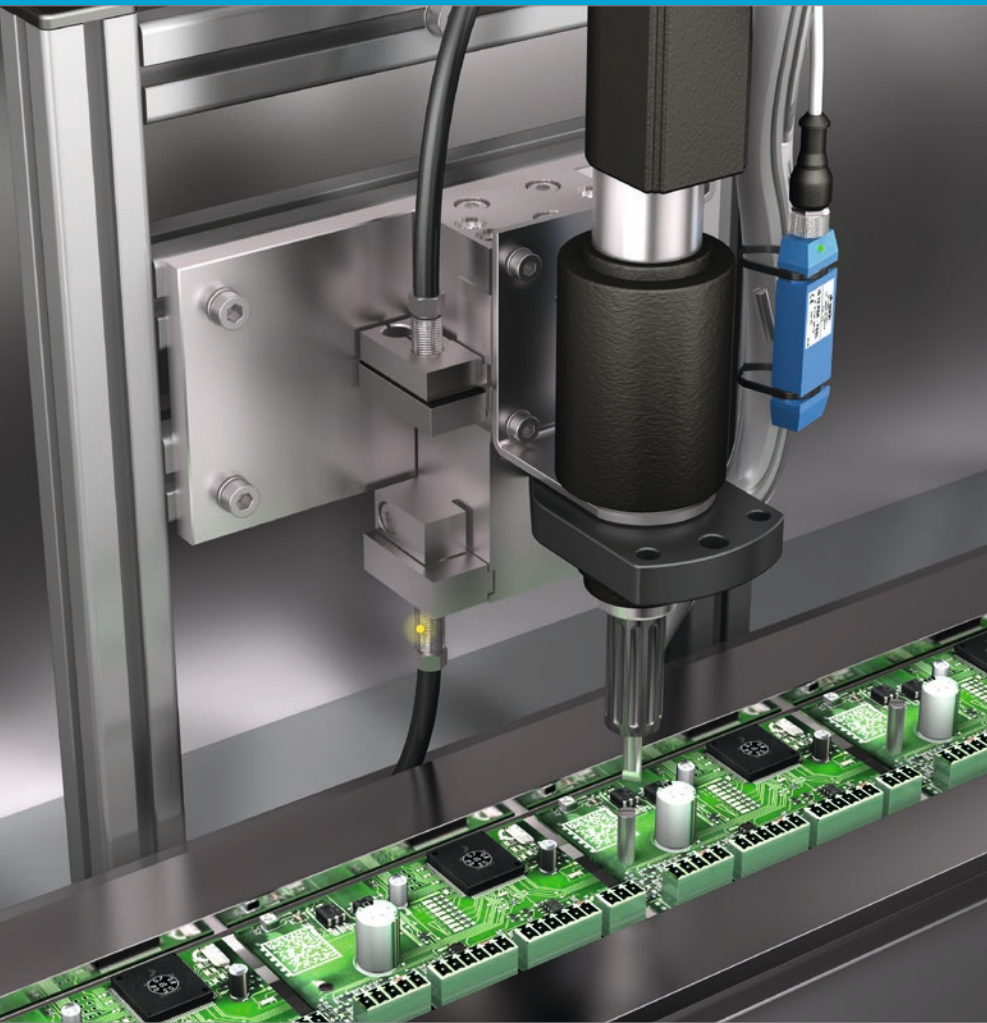

Inductive tube sensors are available with static or dynamic evaluation. The very high detection sensitivity enables detection of metal parts with very low mass at a very high part speed. A special shield enables multiple sensors to be lined up without impacting one another. Tube sensors can be very quickly adapted to various tube cross sections thanks to their compact design and universal mounting system, even without removing the supply tube.

Inductive tube sensors with static/dynamic evaluation

- Dynamic or static operating principle
- High resolution
- Short activation time
- Automatic blanking of metalliferous contaminations (ISDP)
- For retrofitting
- Quick mounting by using cable ties
- Low weight
- Compact design
- High protection type IP 67
- Metal connector



Inductive tube sensors with static/dynamic evaluation

Technical data (typ.)	+20°C, 24 VDC
Service voltage	10 to 35 V DC
Voltage drop	2.0 V
Shock/vibration load	30 g _n /10 to 55 Hz, 1 mm
Speed of parts	< 35 m/s
Ambient temperature	-25 to 70 °C
Protection type	IP 67
Insulation voltage endurance	500 V
LED display	Switching output yellow, operation green
Housing material	Polycarbonate

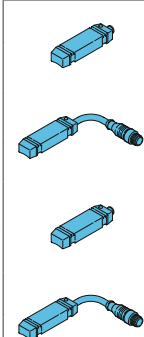
	Housing design Size (mm)	Evaluation: Static (S) / Dynamic (D)	No-load current (mA)	Resolution, steel ball (mm)	Switching output	Pulse stretching (ms)	Cable length (mm), Plug connector	Connection cable (optionally available)	Product description
	70 x 20 x 12	T	15	**	pnp, 200 mA, NO	100	M8	TK ...	IS 70 PSK-TSSL
					npn, 200 mA, NO		50/M12	VK ...	IS 70 NSK-TSSL
					pnp, 200 mA, NO				IS 70 PSLK-K-BS
					npn, 200 mA, NO		IS 70 NSLK-K-BS		
	70 x 20 x 12	D	25	**	pnp, 200 mA, NO	100	M8	TK ...	ISDP 70 PSK-TSSL
					npn, 200 mA, NO		50/M12	VK ...	ISDP 70 NSK-TSSL
					pnp, 200 mA, NO				ISDP 70 PSLK-K-BS
					npn, 200 mA, NO		ISDP 70 NSLK-K-BS		

** Depends on the supply tube used

Label sensors



Are you a labeling machine manufacturer, or do you process labels and want to position them on a product with precision?

di-soric label sensors detect all label materials and have a high repeat accuracy.

Optical label sensors

- Can be integrated directly on the dispensing edge
- Auto-teach during a running process
- Remote teach option
- Key lock function
- LED indicator for the teach procedure
- Detection of an extremely wide range of different labels
- Robust metal housing

Capacitive label sensors

- Detection of all label materials, even metallic ones
- High switching frequency
- Auto-teach during a running process
- Remote teach option
- Key lock function
- LED indicator for the teach procedure
- Temperature and air humidity compensation
- Separable housing for cleaning the sensor slot

Ultrasonic label sensor





- Detection of metallic foil labels, transparent labels and paper labels
- Intuitive teach-in using a membrane keyboard and with fine adjustment
- Remote teach with key-lock function
- Robust metal housing
- Large fork width and fork depth
- High reproducibility
- Short activation time
- Warning output (PIN 2)
- IO-Link
- Parallel operation switching output (Pin2) and IO-Link communication (Pin4)



Detection	Optical	Capacitive	Ultrasonic
Series	OGUTI	KSSTI	UGUTI
Very small labels	✓	✓	✓
Transparent labels		✓	✓
Metallic labels	✓		✓
Very thin labels	✓	✓	✓
Thick labels	✓	✓	✓
Booklets	✓		✓
Thick carrier material		✓	✓

Special requirements	Optical	Capacitive	Ultrasonic
Exact positioning	✓	✓	✓
Maximum belt speed	✓		
Maximum reproducibility	✓		
Mounting directly on the dispensing edge	✓		
IO-Link			✓
Manual teach			✓
Auto-teach	✓	✓	✓
Remote teach	✓	✓	✓
Adjustable pulse stretching (using IO-Link)			✓
Warning output			✓

Technical data (typ.)	+20 °C, 24 VDC
Service voltage	10 to 35 V DC
Ambient temperature	-10 to +60 °C (OGUTI...)
	0 to +60 °C (KSSTI... / UGUTI...)
Housing material	Die-cast zinc, varnished (OGUTI...)
	Aluminum, black anodized (KSSTI... / UGUTI 6/70...)

	Fork/slot width (mm)	Slot depth (mm)	Infrared light, 880 nm, clocked	Switching output	IO-Link interface	No-load current (mA)	Activation time (µs)	Max. belt speed (m/min)	Reproducibility (µm)	Sensitivity adjustment using teach button	Sensitivity adjustment using remote teaching	Plug connector	Connection cable (optionally available)	Product description
Optical label sensors														
	2	40	■	pnp 200 mA, NO/NC		35	166	500	< 50	■	■	M8	TK ... TK ... /4	OGUTI 002 P3K-TSSL OGUTI 002 FP3K-TSSL
	5	50	■	Push-pull 200 mA, NO/NC		35	166	500	< 50	■	■	M8	TK ... TK ... /4	OGUTI 005/50 G3K-TSSL OGUTI 005/50 FG3K-TSSL
Capacitive label sensors														
	0.4	50		Push-pull 200 mA, NO/NC		70	< 600	300 ¹⁾	< 150 ²⁾	■	■	M8	TK ... TK ... /4	KSSTI 400 G3K-TSSL KSSTI 400 FG3K-TSSL
	0.6	50		Push-pull 200 mA, NO/NC		70	< 600	300 ¹⁾	< 150 ²⁾	■	■	M8	TK ... TK ... /4	KSSTI 600 G3K-TSSL KSSTI 600 FG3K-TSSL
	1.0	50		Push-pull 200 mA, NO/NC		70	< 600	300 ¹⁾	< 150 ²⁾	■	■	M8	TK ... TK ... /4	KSSTI 1000 G3K-TSSL KSSTI 1000 FG3K-TSSL
	0.6	85		Push-pull 200 mA, NO/NC		70	< 600	300 ¹⁾	< 150 ²⁾	■	■	M12	VK .../4	KSSTI 600/80 FG3LK-IBS KSSTI 1000/80 FG3LK-IBS
	1.0	85		Push-pull 200 mA, NO/NC		70	< 600	300 ¹⁾	< 150 ²⁾	■	■	M12 (radial)	VK .../4	KSSTI 600/80 FG3LK-AIBS KSSTI 1000/80 FG3LK-AIBS
Ultrasonic label sensors with IO-Link														
	6	70		2 independent outputs, push-pull, 100 mA, NO/NC	■	40	< 250	250 ¹⁾	< 200 ²⁾	■	■	M12 M12 (radial)	VK .../5	UGUTI 6/70 G6-B5 UGUTI 6/70 G6-RB5

¹⁾ 2mm label and 2mm gap

²⁾ Depends on the label material and carrier material

Inductive proximity switch

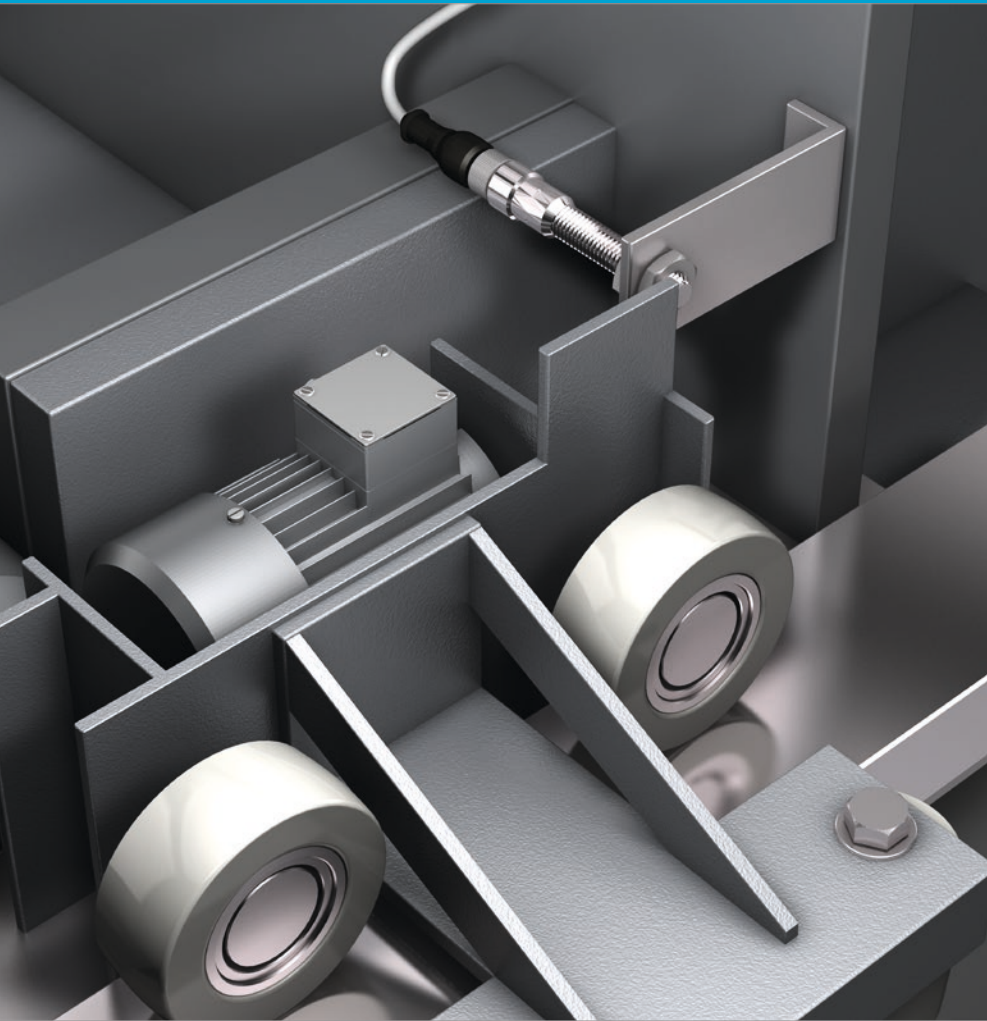

Inductive proximity switches

- High-temperature resistant versions up to 230 °C
- Pressure-resistant versions up to 500 bar
- Versions with a closed stainless-steel sleeve
- Switching distances up to 3 times more than the standard switching distance
- Versions with analog output
- Food-safe and saltwater-resistant versions
- Designs Ø3mm up to M30
- Rectangular designs 5x5 up to 41x80x100 mm









Miniature design

- Small design suitable for installation in the tightest of spaces
- Up to 3 times the switching distance
- High switching frequency for fast applications



Technical data (typ.)	+20 °C, 24 VDC
Installation instructions	flush / non-flush / quasi-flush (see page 121)
For more information, visit	www.di-soric.com







	Housing design Size (mm)	Switching distance (mm)	flush (f) / non-flush (nf) / quasi-flush (qf)	Switching output	Housing material	Cable length, plug connector	Connection cable (optionally available)	Product description
Inductive proximity switch cylindrical design								
	Ø3.0x22	0.6	f	pnp, 200 mA, NO pnp, 200 mA, NC npn, 200 mA, NO npn, 200 mA, NC	V2A	2.0m		DCC 3.0 V 0.6 PSLK DCC 3.0 V 0.6 POLK DCC 3.0 V 0.6 NSLK DCC 3.0 V 0.6 NOLK
	Ø3.0x22	0.6	f	pnp, 200 mA, NO pnp, 200 mA, NC npn, 200 mA, NO npn, 200 mA, NC	V2A	0.2m/M8	TK ...	DCC 3.0 V 0.6 PSK-K-TSL DCC 3.0 V 0.6 POK-K-TSL DCC 3.0 V 0.6 NSK-K-TSL DCC 3.0 V 0.6 NOK-K-TSL
	Ø3.0x22	1.0	f	pnp, 200 mA, NO pnp, 200 mA, NC npn, 200 mA, NO npn, 200 mA, NC	V2A	2.0m		DCC 3.0 V 1.0 PSLK DCC 3.0 V 1.0 POLK DCC 3.0 V 1.0 NSLK DCC 3.0 V 1.0 NOLK
	Ø3.0x22	1.0	f	pnp, 200 mA, NO pnp, 200 mA, NC npn, 200 mA, NO npn, 200 mA, NC	V2A	0.15m/M8	TK ...	DCC 3.0 V 1.0 PSK-K-TSL DCC 3.0 V 1.0 POK-K-TSL DCC 3.0 V 1.0 NSK-K-TSL DCC 3.0 V 1.0 NOK-K-TSL
	Ø4.0x25	0.8	f	pnp, 100 mA, NO pnp, 100 mA, NC npn, 100 mA, NO npn, 100 mA, NC	V2A	2.0m		DCC 4.0 V 0.8 PSLK DCC 4.0 V 0.8 POLK DCC 4.0 V 0.8 NSLK DCC 4.0 V 0.8 NOLK
	Ø4.0x25	0.8	f	pnp, 100 mA, NO pnp, 100 mA, NC npn, 100 mA, NO npn, 100 mA, NC	V2A	0.2m/M8	TK ...	DCC 4.0 V 0.8 PSK-KR-TSL DCC 4.0 V 0.8 POK-KR-TSL DCC 4.0 V 0.8 NSK-KR-TSL DCC 4.0 V 0.8 NOK-KR-TSL
	Ø4.0x38	0.8	f	pnp, 100 mA, NO pnp, 100 mA, NC npn, 100 mA, NO npn, 100 mA, NC	V2A	M8	TK ...	DCC 4.0 V 0.8 PSK-TSL DCC 4.0 V 0.8 POK-TSL DCC 4.0 V 0.8 NSK-TSL DCC 4.0 V 0.8 NOK-TSL









Inductive proximity switch

Miniature design

	Housing design Size (mm)	Switching distance (mm)	flush (f) / non-flush (nf) / quasi-flush (qf)	Switching output	Housing material	Cable length, plug connector	Connection cable (optionally available)	Product description
Inductive proximity switch cylindrical design								
	Ø4.0x25	1.5	f	pnp, 100 mA, NO pnp, 100 mA, NC npn, 100 mA, NO npn, 100 mA, NC	V2A	2.0m		DCC 4.0 V 1.5 PSLK DCC 4.0 V 1.5 POLK DCC 4.0 V 1.5 NSLK DCC 4.0 V 1.5 NOLK
	Ø4.0x38	1.5	f	pnp, 100 mA, NO pnp, 100 mA, NC npn, 100 mA, NO npn, 100 mA, NC	V2A	M8	TK ...	DCC 4.0 V 1.5 PSK-TSL DCC 4.0 V 1.5 POK-TSL DCC 4.0 V 1.5 NSK-TSL DCC 4.0 V 1.5 NOK-TSL
	Ø4.0x25	2.5	f	pnp, 200 mA, NO pnp, 200 mA, NC npn, 200 mA, NO npn, 200 mA, NC	V2A	2.0m		DCC 4.0 V 2.5 PSLK DCC 4.0 V 2.5 POLK DCC 4.0 V 2.5 NSLK DCC 4.0 V 2.5 NOLK
	Ø4.0x38	2.5	f	pnp, 200 mA, NO pnp, 200 mA, NC npn, 200 mA, NO npn, 200 mA, NC	V2A	M8	TK ...	DCC 4.0 V 2.5 PSK-TSL DCC 4.0 V 2.5 POK-TSL DCC 4.0 V 2.5 NSK-TSL DCC 4.0 V 2.5 NOK-TSL

	Housing design Size (mm)	Switching distance (mm)	flush (f) / non-flush (nf) / quasi-flush (qf)	Switching output	Housing material	Cable length, plug connector	Connection cable (optionally available)	Product description
Inductive proximity switch helical design								
	M4 x 22	0.6	f	pnp, 200 mA, NO pnp, 200 mA, NC npn, 200 mA, NO npn, 200 mA, NC	V2A	2.0m		DCC 04 M 0.6 PSLK DCC 04 M 0.6 POLK DCC 04 M 0.6 NSLK DCC 04 M 0.6 NOLK
	M4 x 22	0.6	f	pnp, 200 mA, NO pnp, 200 mA, NC npn, 200 mA, NO npn, 200 mA, NC	V2A	0.2 m/M8	TK ...	DCC 04 M 0.6 PSK-K-TSL DCC 04 M 0.6 POK-K-TSL DCC 04 M 0.6 NSK-K-TSL DCC 04 M 0.6 NOK-K-TSL
	M4 x 22	1.0	f	pnp, 200 mA, NO pnp, 200 mA, NC npn, 200 mA, NO npn, 200 mA, NC	V2A	2.0m		DCC 04 V 1.0 PSLK DCC 04 V 1.0 POLK DCC 04 V 1.0 NSLK DCC 04 V 1.0 NOLK
	M4 x 22	1.0	f	pnp, 200 mA, NO pnp, 200 mA, NC npn, 200 mA, NO npn, 200 mA, NC	V2A	0.2 m/M8	TK ...	DCC 04 V 1.0 PSK-K-TSL DCC 04 V 1.0 POK-K-TSL DCC 04 V 1.0 NSK-K-TSL DCC 04 V 1.0 NOK-K-TSL
	M5 x 25	0.8	f	pnp, 100 mA, NO pnp, 100 mA, NC npn, 100 mA, NO npn, 100 mA, NC	V2A	2.0m		DCC 05 V 0.8 PSLK DCC 05 V 0.8 POLK DCC 05 V 0.8 NSLK DCC 05 V 0.8 NOLK

Miniature design

	Housing design Size (mm)	Switching distance (mm)	flush (f) / non-flush (nf) / quasi-flush (qf)	Switching output	Housing material	Cable length, plug connector	Connection cable (optionally available)	
Inductive proximity switch helical design								Product description
	M5 x 38	0.8	f	pnp, 100 mA, NO pnp, 100 mA, NC npn, 100 mA, NO npn, 100 mA, NC	V2A	M8	TK ...	DCC 05 V 0.8 PSK-TSL DCC 05 V 0.8 POK-TSL DCC 05 V 0.8 NSK-TSL DCC 05 V 0.8 NOK-TSL
	M5 x 25	1.5	f	pnp, 100 mA, NO pnp, 100 mA, NC npn, 100 mA, NO npn, 100 mA, NC	V2A	2.0m		DCC 05 V 1.5 PSLK DCC 05 V 1.5 POLK DCC 05 V 1.5 NSLK DCC 05 V 1.5 NOLK
	M5 x 38	1.5	f	pnp, 100 mA, NO pnp, 100 mA, NC npn, 100 mA, NO npn, 100 mA, NC	V2A	M8	TK ...	DCC 05 V 1.5 PSK-TSL DCC 05 V 1.5 POK-TSL DCC 05 V 1.5 NSK-TSL DCC 05 V 1.5 NOK-TSL
	M5 x 25	2.5	f	pnp, 200 mA, NO pnp, 200 mA, NC npn, 200 mA, NO	V2A	2.0m		DCC 05 V 2.5 PSLK DCC 05 V 2.5 POLK DCC 05 V 2.5 NSLK
	M5 x 38	2.5	f	pnp, 200 mA, NO pnp, 200 mA, NC npn, 200 mA, NO npn, 200 mA, NC	V2A	M8	TK ...	DCC 05 V 2.5 PSK-TSL DCC 05 V 2.5 POK-TSL DCC 05 V 2.5 NSK-TSL DCC 05 V 2.5 NOK-TSL
Inductive proximity switch rectangular design								Product description
	5 x 5 x 25	0.8	f	pnp, 200 mA, NO pnp, 200 mA, NC npn, 200 mA, NO npn, 200 mA, NC	Brass nickel plated	2.0m		DCCQ 05 M 0.8 PSLK DCCQ 05 M 0.8 POLK DCCQ 05 M 0.8 NSLK DCCQ 05 M 0.8 NOLK
	5 x 5 x 25	0.8	f	pnp, 200 mA, NO pnp, 200 mA, NC npn, 200 mA, NO npn, 200 mA, NC	Brass nickel plated	0.2m/M8	TK ...	DCCQ 05 M 0.8 PSK-K-TSL DCCQ 05 M 0.8 POK-K-TSL DCCQ 05 M 0.8 NSK-K-TSL DCCQ 05 M 0.8 NOK-K-TSL
	5 x 5 x 25	1.5	f	pnp, 200 mA, NO pnp, 200 mA, NC npn, 200 mA, NO npn, 200 mA, NC	Brass nickel plated	2.0m		DCCQ 05 M 1.5 PSLK DCCQ 05 M 1.5 POLK DCCQ 05 M 1.5 NSLK DCCQ 05 M 1.5 NOLK
	5 x 5 x 25	1.5	f	pnp, 200 mA, NO pnp, 200 mA, NC npn, 200 mA, NO npn, 200 mA, NC	Brass nickel plated	0.2m/M8	TK ...	DCCQ 05 M 1.5 PSK-K-TSL DCCQ 05 M 1.5 POK-K-TSL DCCQ 05 M 1.5 NSK-K-TSL DCCQ 05 M 1.5 NOK-K-TSL

Inductive proximity switch

Standard switching distance Sn









- Designs M8–M30
- Standard switching distance
- Very high switching frequencies
- Very high function reserves

Technical data (typ.)	+20 °C, 24 VDC
Installation instructions	flush / non-flush / quasi-flush (see page 121)
For more information, visit	www.di-soric.com









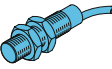
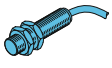

	Housing design Size (mm)	Switching distance (mm)	flush (f) / non-flush (nf)	Switching output	Housing material	Cable length, plug connector	Connection cable (optionally available)	Product description
	M8 x 45	1.5	f	pnp, 200 mA, NO	Brass nickel plated	2.0m		DCB 08 MB 1.5 PS-3
				nnp, 200 mA, NO				DCB 08 MB 1.5 NS-3
	M8 x 50	1.5	f	pnp, 200 mA, NO	Brass nickel plated	M8	TK ...	DCB 08 MB 1.5 PS-T3
				nnp, 200 mA, NO				DCB 08 MB 1.5 NS-T3
	M8 x 36	1.5	f	pnp, 200 mA, NO	Brass nickel plated	2.0m		DCBK 08 MB 1.5 PS-3
				nnp, 200 mA, NO				DCBK 08 MB 1.5 NS-3
	M8 x 40	1.5	f	pnp, 200 mA, NO	Brass nickel plated	M8	TK ...	DCBK 08 MB 1.5 PS-T3
				nnp, 200 mA, NO				DCBK 08 MB 1.5 NS-T3
	M8 x 35	1.5	f	pnp, 200 mA, NO	Brass nickel plated	2.0m		DCC 08 M 1.5 PSLK
				pnp, 200 mA, NC				DCC 08 M 1.5 POLK
				nnp, 200 mA, NO				DCC 08 M 1.5 NSLK
				nnp, 200 mA, NC				DCC 08 M 1.5 NOLK
	M8 x 22	1.5	f	pnp, 200 mA, NO	Brass nickel plated	2.0m		DCC 08 M 1.5 PSLK/22
				pnp, 200 mA, NC				DCC 08 M 1.5 POLK/22
				nnp, 200 mA, NO				DCC 08 M 1.5 NSLK/22
				nnp, 200 mA, NC				DCC 08 M 1.5 NOLK/22
	M8 x 30	1.5	f	pnp, 200 mA, NO	Brass nickel plated	2.0m		DCC 08 M 1.5 PSLK/30
				pnp, 200 mA, NC				DCC 08 M 1.5 POLK/30
				nnp, 200 mA, NO				DCC 08 M 1.5 NSLK/30
				nnp, 200 mA, NC				DCC 08 M 1.5 NOLK/30
	M8 x 45	1.5	f	pnp, 200 mA, NO	Brass nickel plated	M8	TK ...	DCC 08 M 1.5 PSK-TSL
				pnp, 200 mA, NC				DCC 08 M 1.5 POK-TSL
				nnp, 200 mA, NO				DCC 08 M 1.5 NSK-TSL
				nnp, 200 mA, NC				DCC 08 M 1.5 NOK-TSL
	M8 x 32	1.5	f	pnp, 200 mA, NO	Brass nickel plated	M8	TK ...	DCC 08 M 1.5 PSK-TSL/32
				pnp, 200 mA, NC				DCC 08 M 1.5 POK-TSL/32
				nnp, 200 mA, NO				DCC 08 M 1.5 NSK-TSL/32
				nnp, 200 mA, NC				DCC 08 M 1.5 NOK-TSL/32

Standard switching distance Sn









	Housing design Size (mm)	Switching distance (mm)	flush (f) / non-flush (nf)	Switching output	Housing material	Cable length, plug connector	Connection cable (optionally available)	Product description
Inductive proximity switch helical design								
	M8 x 40	1.5	f	pnp, 200 mA, NO pnp, 200 mA, NC npn, 200 mA, NO npn, 200 mA, NC	V2A	M8	TK ...	DCC 08 M 1.5 PSK-TSL/40 DCC 08 M 1.5 POK-TSL/40 DCC 08 M 1.5 NSK-TSL/40 DCC 08 M 1.5 NOK-TSL/40
	M8 x 45	1.5	f	pnp, 200 mA, NO pnp, 200 mA, NC npn, 200 mA, NO npn, 200 mA, NC	V2A	M12	VK ...	DCC 08 M 1.5 PSK-IBSL DCC 08 M 1.5 POK-IBSL DCC 08 M 1.5 NSK-IBSL DCC 08 M 1.5 NOK-IBSL
	M8 x 16	1.5	f	pnp, 200 mA, NO pnp, 200 mA, NC npn, 200 mA, NO npn, 200 mA, NC	V2A	2.0m		DCCK 08 M 1.5 PSLK DCCK 08 M 1.5 POLK DCCK 08 M 1.5 NSLK DCCK 08 M 1.5 NOLK
	M8 x 45	1.5	f	pnp, 200 mA, NO npn, 200 mA, NO	Brass nickel plated	2.0m		DCB 08 MN 2.5 PS-3 DCB 08 MN 2.5 NS-3
	M8 x 50	2.5	nf	pnp, 200 mA, NO npn, 200 mA, NO	Brass nickel plated	M8	TK ...	DCB 08 MN 2.5 PS-T3 DCB 08 MN 2.5 NS-T3
	M8 x 36	2.5	nf	pnp, 200 mA, NO npn, 200 mA, NO	Brass nickel plated	2.0m		DCBK 08 MN 2.5 PS-3 DCBK 08 MN 2.5 NS-3
	M8 x 40	2.5	nf	pnp, 200 mA, NO npn, 200 mA, NO	Brass nickel plated	M8	TK ...	DCBK 08 MN 2.5 PS-T3 DCBK 08 MN 2.5 NS-T3
	M8 x 45	2.5	nf	pnp, 200 mA, NO pnp, 200 mA, NC npn, 200 mA, NO npn, 200 mA, NC	V2A	M8	TK ...	DCC 08 M 2.5 PSK-TSL DCC 08 M 2.5 POK-TSL DCC 08 M 2.5 NSK-TSL DCC 08 M 2.5 NOK-TSL
	M8 x 48	2.5	nf	pnp, 200 mA, NO pnp, 200 mA, NC npn, 200 mA, NO npn, 200 mA, NC	V2A	M12	VK ...	DCC 08 M 2.5 PSK-IBSL DCC 08 M 2.5 POK-IBSL DCC 08 M 2.5 NSK-IBSL DCC 08 M 2.5 NOK-IBSL

Inductive proximity switch

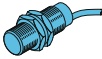
Standard switching distance S_n





	Housing design Size (mm)	Switching distance (mm)	flush (f) / non-flush (nf)	Switching output	Housing material	Cable length, plug connector	Connection cable (optionally available)	Product description
	M12 x 50	2.0	f	pnp, 200 mA, NO	Brass nickel plated	2.0m		DCB 12 MB 02 PS-3
				nnp, 200 mA, NO				DCB 12 MB 02 NS-3
	M12 x 50	2.0	f	pnp, 200 mA, NC	Brass nickel plated	2.0m		DCC 12 M 02 POLK
				nnp, 200 mA, NC				DCC 12 M 02 NOLK
	M12 x 35	2.0	f	pnp, 200 mA, NO	Brass nickel plated	2.0m		DCCK 12 M 02 PSLK
				pnp, 200 mA, NC				DCCK 12 M 02 POLK
				nnp, 200 mA, NO				DCCK 12 M 02 NSLK
				nnp, 200 mA, NC				DCCK 12 M 02 NOLK
	M12 x 65	2.0	f	pnp, 200 mA, NO	Brass nickel plated	M12	VK ...	DCB 12 MB 02 PS-B3
				nnp, 200 mA, NO				DCB 12 MB 02 NS-B3
	M12 x 53	2.0	f	pnp, 200 mA, NO	Brass nickel plated	M12	VK ...	DCBK 12 MB 02 PS-B3
				pnp, 200 mA, NC				DCBK 12 MB 02 PO-B3
				nnp, 200 mA, NO				DCBK 12 MB 02 NS-B3
	M12 x 60	2.0	f	pnp, 200 mA, NC	Brass nickel plated	M12	VK ...	DCC 12 M 02 POK-IBSL
				nnp, 200 mA, NC				DCC 12 M 02 NOK-IBSL
	M12 x 45	2.0	f	pnp, 200 mA, NO	Brass nickel plated	M12	VK ...	DCCK 12 M 02 PSK-IBSL
				pnp, 200 mA, NC				DCCK 12 M 02 POK-IBSL
				nnp, 200 mA, NO				DCCK 12 M 02 NSK-IBSL
				nnp, 200 mA, NC				DCCK 12 M 02 NOK-IBSL
	M12 x 50	4.0	nf	pnp, 200 mA, NO	Brass nickel plated	2.0m		DCB 12 MN 04 PS-3
				nnp, 200 mA, NO				DCB 12 MN 04 NS-3
	M12 x 65	4.0	nf	pnp, 200 mA, NO	Brass nickel plated	M12	VK ...	DCB 12 MN 04 PS-B3
				nnp, 200 mA, NO				DCB 12 MN 04 NS-B3
	M12 x 50	4.0	nf	pnp, 200 mA, NO	Brass nickel plated	2.0m		DCC 12 M 04 PSLK
				pnp, 200 mA, NC				DCC 12 M 04 POLK
				nnp, 200 mA, NO				DCC 12 M 04 NSLK
				nnp, 200 mA, NC				DCC 12 M 04 NOLK

Standard switching distance S_n



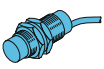

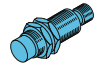
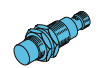
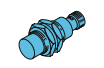
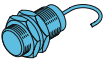



	Housing design Size (mm)	Switching distance (mm)	flush (f) / non-flush (nf)	Switching output	Housing material	Cable length, plug connector	Connection cable (optionally available)	
Inductive proximity switch helical design								Product description
	M12 x 35	4.0	nf	pnp, 200 mA, NO	Brass nickel plated	2.0m		DCCK 12 M 04 PSLK
				pnp, 200 mA, NC				DCCK 12 M 04 POLK
				npn, 200 mA, NO				DCCK 12 M 04 NSLK
				npn, 200 mA, NC				DCCK 12 M 04 NOLK
	M12 x 60	4.0	nf	pnp, 200 mA, NO	Brass nickel plated	M12	VK...	DCC 12 M 04 PSK-IBSL
				pnp, 200 mA, NC				DCC 12 M 04 POK-IBSL
				npn, 200 mA, NO				DCC 12 M 04 NSK-IBSL
				npn, 200 mA, NC				DCC 12 M 04 NOK-IBSL
	M12 x 45	4.0	nf	pnp, 200 mA, NO	Brass nickel plated	M12	VK...	DCCK 12 M 04 PSK-IBSL
				pnp, 200 mA, NC				DCCK 12 M 04 POK-IBSL
				npn, 200 mA, NO				DCCK 12 M 04 NSK-IBSL
				npn, 200 mA, NC				DCCK 12 M 04 NOK-IBSL
	M18 x 50	5.0	f	pnp, 400 mA, NO	Brass nickel plated	2.0m		DCB 18 MB 05 PS-3
				npn, 400 mA, NO				DCB 18 MB 05 NS-3
	M18 x 50	5.0	f	pnp, 200 mA, NO	Brass nickel plated	2.0m		DCC 18 M 05 PSLK
				pnp, 200 mA, NC				DCC 18 M 05 POLK
				npn, 200 mA, NO				DCC 18 M 05 NSLK
				npn, 200 mA, NC				DCC 18 M 05 NOLK
	M18 x 35	5.0	f	pnp, 200 mA, NO	Brass nickel plated	2.0m		DCCK 18 M 05 PSLK
				pnp, 200 mA, NC				DCCK 18 M 05 POLK
				npn, 200 mA, NO				DCCK 18 M 05 NSLK
				npn, 200 mA, NC				DCCK 18 M 05 NOLK
	M18 x 64	5.0	f	pnp, 400 mA, NO	Brass nickel plated	M12	VK...	DCB 18 MB 05 PS-B3
				npn, 400 mA, NO				DCB 18 MB 05 NS-B3
	M18 x 65	5.0	f	pnp, 200 mA, NO	Brass nickel plated	M12	VK...	DCC 18 M 05 PSK-IBSL
				pnp, 200 mA, NC				DCC 18 M 05 POK-IBSL
				npn, 200 mA, NO				DCC 18 M 05 NSK-IBSL
				npn, 200 mA, NC				DCC 18 M 05 NOK-IBSL
	M18 x 50	5.0	f	pnp, 200 mA, NO	Brass nickel plated	M12	VK...	DCCK 18 M 05 PSK-IBSL
				pnp, 200 mA, NC				DCCK 18 M 05 POK-IBSL
				npn, 200 mA, NO				DCCK 18 M 05 NSK-IBSL
				npn, 200 mA, NC				DCCK 18 M 05 NOK-IBSL

Inductive proximity switch

Standard switching distance S_n







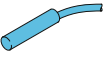

	Housing design Size (mm)	Switching distance (mm)	flush (f) / non-flush (nf)	Switching output	Housing material	Cable length, plug connector	Connection cable (optionally available)	Product description
Inductive proximity switch helical design								
	M18 x 50	8.0	nf	pnp, 400 mA, NO	Brass nickel plated	2.0m		DCB 18 MN 08 PS-3
				npn, 400 mA, NO				DCB 18 MN 08 NS-3
	M18 x 50	8.0	nf	pnp, 200 mA, NO	Brass nickel plated	2.0m		DCC 18 M 08 PSLK
				pnp, 200 mA, NC				DCC 18 M 08 POLK
				npn, 200 mA, NO				DCC 18 M 08 NSLK
				npn, 200 mA, NC				DCC 18 M 08 NOLK
	M18 x 35	8.0	nf	pnp, 200 mA, NO	Brass nickel plated	2.0m		DCCK 18 M 08 PSLK
				pnp, 200 mA, NC				DCCK 18 M 08 POLK
				npn, 200 mA, NO				DCCK 18 M 08 NSLK
				npn, 200 mA, NC				DCCK 18 M 08 NOLK
	M18 x 64	8.0	nf	pnp, 400 mA, NO	Brass nickel plated	M12	VK ...	DCB 18 MN 08 PS-B3
				npn, 400 mA, NO				DCB 18 MN 08 NS-B3
	M18 x 65	8.0	nf	pnp, 200 mA, NO	Brass nickel plated	M12	VK ...	DCC 18 M 08 PSK-IBSL
				pnp, 200 mA, NC				DCC 18 M 08 POK-IBSL
				npn, 200 mA, NO				DCC 18 M 08 NSK-IBSL
				npn, 200 mA, NC				DCC 18 M 08 NOK-IBSL
	M18 x 50	8.0	nf	pnp, 200 mA, NO	Brass nickel plated	M12	VK ...	DCCK 18 M 08 PSK-IBSL
				pnp, 200 mA, NC				DCCK 18 M 08 POK-IBSL
				npn, 200 mA, NO				DCCK 18 M 08 NSK-IBSL
				npn, 200 mA, NC				DCCK 18 M 08 NOK-IBSL
	M30 x 60	10.0	f	pnp, 400 mA, NO	Brass nickel plated	2.0m		DCB 30 MB 10 PS-3
				npn, 400 mA, NO				DCB 30 MB 10 NS-3
	M30 x 52	10.0	f	pnp, 200 mA, NO	Brass nickel plated	2.0m		DCC 30 M 10 PSLK
				pnp, 200 mA, NC				DCC 30 M 10 POLK
				npn, 200 mA, NO				DCC 30 M 10 NSLK
				npn, 200 mA, NC				DCC 30 M 10 NOLK
	M30 x 36	10.0	f	pnp, 200 mA, NO	Brass nickel plated	2.0m		DCCK 30 M 10 PSLK
				pnp, 200 mA, NC				DCCK 30 M 10 POLK
				npn, 200 mA, NO				DCCK 30 M 10 NSLK
				npn, 200 mA, NC				DCCK 30 M 10 NOLK

Standard switching distance S_n





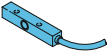





	Housing design Size (mm)	Switching distance (mm)	flush (f) / non-flush (nf)	Switching output	Housing material	Cable length, plug connector	Connection cable (optionally available)	Product description
	M30 x 76	10.0	f	pnp, 400 mA, NO	Brass nickel plated	M12	VK...	DCB 30 MB 10 PS-B3
				npn, 400 mA, NO				DCB 30 MB 10 NS-B3
	M30 x 64	10.0	f	pnp, 200 mA, NO	Brass nickel plated	M12	VK...	DCC 30 M 10 PSK-IBSL
				pnp, 200 mA, NC				DCC 30 M 10 POK-IBSL
				npn, 200 mA, NO				DCC 30 M 10 NOK-IBSL
				npn, 200 mA, NC				DCC 30 M 10 NSK-IBSL
	M30 x 50	10.0	f	pnp, 200 mA, NO	Brass nickel plated	M12	VK...	DCCK 30 M 10 PSK-IBSL
				pnp, 200 mA, NC				DCCK 30 M 10 POK-IBSL
				npn, 200 mA, NO				DCCK 30 M 10 NSK-IBSL
				npn, 200 mA, NC				DCCK 30 M 10 NOK-IBSL
	M30 x 53	15.0	nf	pnp, 200 mA, NO	Brass nickel plated	2.0m		DCC 30 M 15 PSLK
				pnp, 200 mA, NC				DCC 30 M 15 POLK
				npn, 200 mA, NO				DCC 30 M 15 NSLK
				npn, 200 mA, NC				DCC 30 M 15 NOLK
	M30 x 60	15.0	f	pnp, 400 mA, NO	Brass nickel plated	2.0m		DCB 30 MN 15 PS-3
				npn, 400 mA, NO				DCB 30 MN 15 NS-3
	M30 x 76	15.0	f	pnp, 400 mA, NO	Brass nickel plated	M12	VK...	DCB 30 MN 15 PS-B3
				npn, 400 mA, NO				DCB 30 MN 15 NS-B3
	M30 x 35	15.0	nf	pnp, 200 mA, NO	Brass nickel plated	2.0m		DCCK 30 M 15 PSLK
				pnp, 200 mA, NC				DCCK 30 M 15 POLK
				npn, 200 mA, NO				DCCK 30 M 15 NSLK
				npn, 200 mA, NC				DCCK 30 M 15 NOLK
	M30 x 66	15.0	nf	pnp, 200 mA, NO	Brass nickel plated	M12	VK...	DCC 30 M 15 PSK-IBSL
				pnp, 200 mA, NC				DCC 30 M 15 POK-IBSL
				npn, 200 mA, NO				DCC 30 M 15 POK-IBSL
				npn, 200 mA, NC				DCC 30 M 15 NOK-IBSL
	M30 x 52	15.0	nf	pnp, 200 mA, NO	Brass nickel plated	M12	VK...	DCCK 30 M 15 PSK-IBSL
				pnp, 200 mA, NC				DCCK 30 M 15 POK-IBSL
				npn, 200 mA, NO				DCCK 30 M 15 NSK-IBSL
				npn, 200 mA, NC				DCCK 30 M 15 NOK-IBSL

Inductive proximity switch

Standard switching distance S_n

	Housing design Size (mm)	Switching distance (mm)	flush (f) / non-flush (nf)	Switching output	Housing material	Cable length, plug connector	Connection cable (optionally available)	Product description
Inductive proximity switch cylindrical design								Product description
	Ø 6.5x36	1.5	f	pnp, 200 mA, NO pnp, 200 mA, NC npn, 200 mA, NO npn, 200 mA, NC	V2A	2.0m		DCC 6.5 V 1.5 PSLK DCC 6.5 V 1.5 POLK DCC 6.5 V 1.5 NSLK DCC 6.5 V 1.5 NOLK
	Ø 6.5x45	1.5	f	pnp, 200 mA, NO pnp, 200 mA, NC npn, 200 mA, NO npn, 200 mA, NC	V2A	M8	TK ...	DCC 6.5 V 1.5 PSK-TSL DCC 6.5 V 1.5 POK-TSL DCC 6.5 V 1.5 NSK-TSL DCC 6.5 V 1.5 NOK-TSL
	Ø 6.5x16	1.5	f	pnp, 200 mA, NO pnp, 200 mA, NC npn, 200 mA, NO npn, 200 mA, NC	V2A	2.0m		DCCK 6.5 V 1.5 PSLK DCCK 6.5 V 1.5 POLK DCCK 6.5 V 1.5 NSLK DCCK 6.5 V 1.5 NOLK
	Ø 6.5x29	1.5	f	pnp, 200 mA, NO pnp, 200 mA, NC npn, 200 mA, NO npn, 200 mA, NC	V2A	M8	TK ...	DCCK 6.5 V 1.5 PSK-TSL DCCK 6.5 V 1.5 POK-TSL DCCK 6.5 V 1.5 NSK-TSL DCCK 6.5 V 1.5 NOK-TSL
	Ø 6.5x17	1.5	f	pnp, 200 mA, NO pnp, 200 mA, NC npn, 200 mA, NO npn, 200 mA, NC	V2A	2.0m		DCCKR 6.5 V 1.5 PSLK DCCKR 6.5 V 1.5 POLK DCCKR 6.5 V 1.5 NSLK DCCKR 6.5 V 1.5 NOLK
	Ø 6.5x22	1.5	f	pnp, 200 mA, NO pnp, 200 mA, NC npn, 200 mA, NO npn, 200 mA, NC	V2A	2.0m		DCC 6.5 V 1.5 PSLK/22 DCC 6.5 V 1.5 POLK/22 DCC 6.5 V 1.5 NSLK/22 DCC 6.5 V 1.5 NOLK/22
Inductive proximity switch rectangular design								Product description
	8 x 8 x 40	1.5	f	pnp, 200 mA, NO	Brass nickel plated	2.0m		DCQZ 08 M 1.5 PSL
	8 x 8 x 40	1.5	f	pnp, 200 mA, NO	Brass nickel plated	M8	TK ...	DCQZ 08 M 1.5 PSK-TSL
	8 x 8 x 40	1.5	f	pnp, 200 mA, NO pnp, 200 mA, NC npn, 200 mA, NO npn, 200 mA, NC	Brass nickel plated	2.0m		DCCQ 08 M 1.5 PSLK DCCQ 08 M 1.5 POLK DCCQ 08 M 1.5 NSLK DCCQ 08 M 1.5 NOLK

Standard switching distance S_n

	Housing design Size (mm)	Switching distance (mm)	flush (f) / non-flush (nf)	Switching output	Housing material	Cable length, plug connector	Connection cable (optionally available)	
Inductive proximity switch rectangular design								Product description
	8 x 8 x 50	1.5	f	pnp, 200 mA, NO pnp, 200 mA, NC npn, 200 mA, NO npn, 200 mA, NC	Brass nickel plated	M8	TK ...	DCCQ 08 M 1.5 PSK-TSL DCCQ 08 M 1.5 POK-TSL DCCQ 08 M 1.5 NSK-TSL DCCQ 08 M 1.5 NOK-TSL
	28 x 16 x 10	2.0	f	pnp, 200 mA, NO pnp, 200 mA, NC npn, 200 mA, NO npn, 200 mA, NC	Plastic	2.0m		DCR 30 K 02 PSLK DCR 30 K 02 POLK DCR 30 K 02 NSLK DCR 30 K 02 NOLK
	28 x 16 x 10	2.0	f	pnp, 200 mA, NO pnp, 200 mA, NC npn, 200 mA, NO npn, 200 mA, NC	Plastic	M8	TK ...	DCR 30 K 02 PSK-TSL DCR 30 K 02 POK-TSL DCR 30 K 02 NSK-TSL DCR 30 K 02 NOK-TSL
	40 x 26 x 12	2.0	f	pnp, 200 mA, NO pnp, 200 mA, NC npn, 200 mA, NO npn, 200 mA, NC	Plastic	2.0m		DCR 40 K 02 PSLK DCR 40 K 02 POLK DCR 40 K 02 NSLK DCR 40 K 02 NOLK
	40 x 26 x 12	2.0	f	pnp, 200 mA, NO pnp, 200 mA, NC npn, 200 mA, NO npn, 200 mA, NC	Plastic	2.0m	TK ...	DCR 40 K 02 PSK-TSL DCR 40 K 02 POK-TSL DCR 40 K 02 NSK-TSL DCR 40 K 02 NOK-TSL
	40 x 26 x 12	4.0	nf	pnp, 200 mA, NO pnp, 200 mA, NC npn, 200 mA, NO npn, 200 mA, NC	Plastic	2.0m		DCR 40 K 04 PSLK DCR 40 K 04 POLK DCR 40 K 04 NSLK DCR 40 K 04 NOLK
	40 x 26 x 12	4.0	nf	pnp, 200 mA, NO pnp, 200 mA, NC npn, 200 mA, NO npn, 200 mA, NC	Plastic	M8	TK ...	DCR 40 K 04 PSK-TSL DCR 40 K 04 POK-TSL DCR 40 K 04 NSK-TSL DCR 40 K 04 NOK-TSL
	40 x 26 x 12	4.0	nf	pnp, 200 mA, NO	Plastic	M8	TK ...	DCR 40 K 04 V PSK-TSL
	40 x 26 x 12	4.0	nf	pnp, 200 mA, NO	Plastic	2.0m		DCR 40 K 04 V PSLK
	80 x 80 x 40	50	nf	pnp, 200 mA NO/NC antivalent	Plastic	Clamps		DCCR 80 K 50 PSOL-KL

Inductive proximity switch

Increased switching distance Sn









- Switching distance up to 2 times longer than the standard Sn
- High switching frequency
- Various designs

Technical data (typ.)	+20 °C, 24 VDC
Installation instructions	flush / non-flush / quasi-flush (see page 121)
For more information, visit	www.di-soric.com











Housing design Size (mm)	Switching distance (mm)	flush (f) / non-flush (n)	Switching output	Housing material	Cable length, plug connector	Connection cable (optionally available)	Product description
	M8 x 35	2.0	f	pnp, 200 mA, NO	V2A	2.0m	DCC 08 M 02 PSLK
				pnp, 200 mA, NC			DCC 08 M 02 POLK
				nnp, 200 mA, NO			DCC 08 M 02 NSLK
				nnp, 200 mA, NC			DCC 08 M 02 NOLK
	M8 x 45	2.0	f	pnp, 200 mA, NO	Brass nickel plated	2.0m	DCB 08 MB 02 PS-3
				nnp, 200 mA, NO			DCB 08 MB 02 NS-3
	M8 x 36	2.0	f	pnp, 200 mA, NO	Brass nickel plated	M8	DCBK 08 MB 02 PS-3
				nnp, 200 mA, NO			DCBK 08 MB 02 NS-3
	M8 x 16	2.0	f	pnp, 200 mA, NO	V2A	2.0m	DCC 08 M 02 PSLK/16
				pnp, 200 mA, NC			DCC 08 M 02 POLK/16
				nnp, 200 mA, NO			DCC 08 M 02 NSLK/16
				nnp, 200 mA, NC			DCC 08 M 02 NOLK/16
	M8 x 22	2.0	f	pnp, 200 mA, NO	V2A	2.0m	DCC 08 M 02 PSLK/22
				pnp, 200 mA, NC			DCC 08 M 02 POLK/22
				nnp, 200 mA, NO			DCC 08 M 02 NSLK/22
				nnp, 200 mA, NC			DCC 08 M 02 NOLK/22
	M8 x 30	2.0	f	pnp, 200 mA, NO	V2A	2.0m	DCC 08 M 02 PSLK/30
				pnp, 200 mA, NC			DCC 08 M 02 POLK/30
				nnp, 200 mA, NO			DCC 08 M 02 NSLK/30
				nnp, 200 mA, NC			DCC 08 M 02 NOLK/30
	M8 x 50	2.0	f	pnp, 200 mA, NO	Brass nickel plated	M8	TK ...
				nnp, 200 mA, NO			DCB 08 MB 02 NS-T3

Increased switching distance Sn

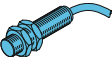

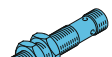

	Housing design Size (mm)	Switching distance (mm)	flush (f) / non-flush (nf)	Switching output	Housing material	Cable length, plug connector	Connection cable (optionally available)	Product description
Inductive proximity switch helical design								
	M8 x 40	2.0	f	pnp, 200 mA, NO	Brass nickel plated	M8	TK ...	DCBK 08 MB 02 PS-T3
				npn, 200 mA, NO				DCBK 08 MB 02 NS-T3
	M8 x 45	2.0	f	pnp, 200 mA, NO	V2A	M8	TK ...	DCC 08 M 02 PSK-TSL
				pnp, 200 mA, NC				DCC 08 M 02 POK-TSL
				nnp, 200 mA, NO				DCC 08 M 02 NSK-TSL
				nnp, 200 mA, NC				DCC 08 M 02 NOK-TSL
	M8 x 29	2.0	f	pnp, 200 mA, NO	V2A	M8	TK ...	DCC 08 M 02 PSK-TSL/29
				pnp, 200 mA, NC				DCC 08 M 02 POK-TSL/29
				nnp, 200 mA, NO				DCC 08 M 02 NSK-TSL/29
				nnp, 200 mA, NC				DCC 08 M 02 NOK-TSL/29
	M8 x 32	2.0	f	pnp, 200 mA, NO	V2A	M8	TK ...	DCC 08 M 02 PSK-TSL/32
				pnp, 200 mA, NC				DCC 08 M 02 POK-TSL/32
				nnp, 200 mA, NO				DCC 08 M 02 NSK-TSL/32
				nnp, 200 mA, NC				DCC 08 M 02 NOK-TSL/32
	M8 x 40	2.0	f	pnp, 200 mA, NO	V2A	M8	TK ...	DCC 08 M 02 PSK-TSL/40
				pnp, 200 mA, NC				DCC 08 M 02 POK-TSL/40
				nnp, 200 mA, NO				DCC 08 M 02 NSK-TSL/40
				nnp, 200 mA, NC				DCC 08 M 02 NOK-TSL/40
	M8 x 46	2.0	f	pnp, 200 mA, NO	V2A	M12	VK ...	DCC 08 M 02 PSK-IBSL
				pnp, 200 mA, NC				DCC 08 M 02 POK-IBSL
				nnp, 200 mA, NO				DCC 08 M 02 NSK-IBSL
				nnp, 200 mA, NC				DCC 08 M 02 NOK-IBSL
	M8 x 45	4.0	nf	pnp, 200 mA, NO	Brass nickel plated	2.0m		DCB 08 MN 04 PS-3
				pnp, 200 mA, NC				DCB 08 MN 04 NS-3
				nnp, 200 mA, NO				DCBK 08 MN 04 PS-3
				nnp, 200 mA, NC				DCBK 08 MN 04 NS-3
	M8 x 35	4.0	nf	pnp, 200 mA, NO	V2A	2.0m		DCC 08 V 04 NB PSLK
				pnp, 200 mA, NC				DCC 08 V 04 NB POLK
				nnp, 200 mA, NO				DCC 08 V 04 NB NSLK
				nnp, 200 mA, NC				DCC 08 V 04 NB NOLK

Inductive proximity switch

Increased switching distance Sn

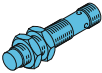





	Housing design Size (mm)	Switching distance (mm)	flush (f) / non-flush (nf)	Switching output	Housing material	Cable length, plug connector	Connection cable (optionally available)	Product description
Inductive proximity switch helical design								
	M8 x 50	4.0	nf	pnp, 200 mA, NO npn, 200 mA, NO	Brass nickel plated	M8	TK...	DCB 08 MN 04 PS-T3 DCB 08 MN 04 NS-T3
	M8x40	4.0	nf	pnp, 200 mA, NO npn, 200 mA, NO	Brass nickel plated	M8	TK...	DCBK 08 MN 04 PS-T3 DCBK 08 MN 04 NS-T3
	M8 x 46	4.0	nf	pnp, 200 mA, NO pnp, 200 mA, NC npn, 200 mA, NO npn, 200 mA, NC	V2A	M8	TK ...	DCC 08 V 04 NB PSK-TSL DCC 08 V 04 NB POK-TSL DCC 08 V 04 NB NSK-TSL DCC 08 V 04 NB NOK-TSL
	M12 x 50	4.0	f	pnp, 200 mA, NO pnp, 200 mA, NC npn, 200 mA, NO	Brass nickel plated	2.0m		DCC 12 M 04 B PSLK DCC 12 M 04 B POLK DCC 12 M 04 B NSLK
	M12 x 35	4.0	f	pnp, 200 mA, NO pnp, 200 mA, NC npn, 200 mA, NO npn, 200 mA, NC	Brass nickel plated	2.0m		DCCK 12 M 04 B PSLK DCCK 12 M 04 B POLK DCCK 12 M 04 B NOLK DCCK 12 M 04 B NSLK
	M12x65	4.0	f	pnp, 200 mA, NO npn, 200 mA, NO	Brass nickel plated	M12	VK ...	DCB 12 MB 04 PS-B3 DCB 12 MB 04 NS-B3
	M12x53	4.0	f	pnp, 200 mA, NO pnp, 200 mA, NC	Brass nickel plated	M12	VK ...	DCBK 12 MB 04 PS-B3 DCBK 12 MB 04 PO-B3
	M12 x 60	4.0	f	pnp, 200 mA, NO pnp, 200 mA, NC npn, 200 mA, NO npn, 200 mA, NC	Brass nickel plated	M12	VK ...	DCC 12 M 04 B PSK-IBSL DCC 12 M 04 B POK-IBSL DCC 12 M 04 B NSK-IBSL DCC 12 M 04 B NOK-IBSL
	M12 x 45	4.0	f	pnp, 200 mA, NO pnp, 200 mA, NC npn, 200 mA, NO	Brass nickel plated	M12	VK ...	DCCK 12 M 04 B PSK-IBSL DCCK 12 M 04 B POK-IBSL DCCK 12 M 04 B NSK-IBSL

Increased switching distance Sn

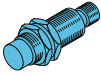



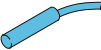
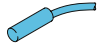
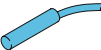



	Housing design Size (mm)	Switching distance (mm)	flush (f) / non-flush (nf)	Switching output	Housing material	Cable length, plug connector	Connection cable (optionally available)	Product description
Inductive proximity switch helical design								
	M12x50	8.0	nf	pnp, 200 mA, NO	Brass nickel plated	2.0m		DCB 12 MN 08 PS-3
				nnp, 200 mA, NO				DCB 12 MN 08 NS-3
	M12x40	8.0	nf	pnp, 200 mA, NO	Brass nickel plated	2.0m		DCBK 12 MN 08 PS-3
				nnp, 200 mA, NO				DCBK 12 MN 08 NS-3
	M12x65	8.0	nf	pnp, 200 mA, NO	Brass nickel plated	M12	VK...	DCB 12 MN 08 PS-B3
				nnp, 200 mA, NO				DCB 12 MN 08 NS-B3
	M12x53	8.0	nf	pnp, 200 mA, NO	Brass nickel plated	M12	VK...	DCBK 12 MN 08 PS-B3
				nnp, 200 mA, NO				DCBK 12 MN 08 NS-B3
	M18x50	8.0	f	pnp, 400 mA, NO	Brass nickel plated	2.0m		DCB 18 MB 08 PS-3
				nnp, 400 mA, NO				DCB 18 MB 08 NS-3
	M18x50	12.0	nf	pnp, 400 mA, NO	Brass nickel plated	2.0m		DCB 18 MN 12 PS-3
				nnp, 400 mA, NO				DCB 18 MN 12 NS-3
	M18x64	8.0	f	pnp, 400 mA, NO	Brass nickel plated	M12	VK...	DCB 18 MB 08 PS-B3
				nnp, 400 mA, NO				DCB 18 MB 08 NS-B3

Inductive proximity switch

Increased switching distance Sn

	Housing design Size (mm)	Switching distance (mm)	flush (f) / non-flush (nf)	Switching output	Housing material	Cable length, plug connector	Connection cable (optionally available)	Product description
Inductive proximity switch helical design								Product description
	M30x64	12.0	nf	pnp, 400 mA, NO nnp, 400 mA, NO	Brass nickel plated	M12	VK ...	DCB 18 MN 12 PS-B3 DCB 18 MN 12 NS-B3
	M30x60	15.0	f	pnp, 400 mA, NO nnp, 400 mA, NO	Brass nickel plated	2.0m		DCB 30 MB 15 PS-3 DCB 30 MB 15 NS-3
	M30x76	15.0	f	pnp, 400 mA, NO nnp, 400 mA, NO	Brass nickel plated	M12	VK ...	DCB 30 MB 15 PS-B3 DCB 30 MB 15 NS-B3
	M30x60	20.0	nf	pnp, 400 mA, NO nnp, 400 mA, NO nnp, 400 mA, NC	Brass nickel plated	2.0m		DCB 30 MN 20 PS-3 DCB 30 MN 20 NS-3 DCB 30 MN 20 NO-3
	M30x76	20.0	nf	pnp, 400 mA, NO nnp, 400 mA, NO	Brass nickel plated	M12	VK ...	DCB 30 MN 20 PS-B3 DCB 30 MN 20 NS-B3
Inductive proximity switch cylindrical design								Product description
	Ø 6.5x35	2.0	f	pnp, 200 mA, NO pnp, 200 mA, NC nnp, 200 mA, NO nnp, 200 mA, NC	V2A	2.0m		DCC 6.5 V 02 PSLK DCC 6.5 V 02 POLK DCC 6.5 V 02 NSLK DCC 6.5 V 02 NOLK
	Ø 6.5x22	2.0	f	pnp, 200 mA, NO pnp, 200 mA, NC nnp, 200 mA, NC	V2A	2.0m		DCC 6.5 V 02 PSLK/22 DCC 6.5 V 02 POLK/22 DCC 6.5 V 02 NOLK/22
	Ø 6.5x30	2.0	f	pnp, 200 mA, NO pnp, 200 mA, NC nnp, 200 mA, NO nnp, 200 mA, NC	V2A	2.0m		DCC 6.5 V 02 PSLK/30 DCC 6.5 V 02 POLK/30 DCC 6.5 V 02 NSLK/30 DCC 6.5 V 02 NOLK/30
	Ø 6.5x45	2.0	f	pnp, 200 mA, NO pnp, 200 mA, NC nnp, 200 mA, NO nnp, 200 mA, NC	V2A	M8	TK ...	DCC 6.5 V 02 PSK-TSL DCC 6.5 V 02 POK-TSL DCC 6.5 V 02 NSK-TSL DCC 6.5 V 02 NOK-TSL

Increased switching distance Sn

	Housing design Size (mm)	Switching distance (mm)	flush (f) / non-flush (nf)	Switching output	Housing material	Cable length, plug connector	Connection cable (optionally available)	
Inductive proximity switch cylindrical design								Product description
	Ø 6.5x29	2.0	f	pnp, 200 mA, NO pnp, 200 mA, NC npn, 200 mA, NO npn, 200 mA, NC	V2A	M8	TK...	DCC 6.5 V 02 PSK-TSL/29 DCC 6.5 V 02 POK-TSL/29 DCC 6.5 V 02 NSK-TSL/29 DCC 6.5 V 02 NOK-TSL/29
	Ø 6.5x40	2.0	f	pnp, 200 mA, NO pnp, 200 mA, NC npn, 200 mA, NO	V2A	M8	TK...	DCC 6.5 V 02 PSK-TSL/40 DCC 6.5 V 02 POK-TSL/40 DCC 6.5 V 02 NOK-TSL/40
	Ø 6.5x17	2.0	f	pnp, 200 mA, NO pnp, 200 mA, NC npn, 200 mA, NO npn, 200 mA, NC	V2A	2.0m		DCCK 6.5 V 02 PSLK DCCK 6.5 V 02 POLK DCCK 6.5 V 02 NSLK DCCK 6.5 V 02 NOLK
	Ø 6.5x17	2.0	f	pnp, 200 mA, NO pnp, 200 mA, NC npn, 200 mA, NO npn, 200 mA, NC	V2A	2.0m		DCCKR 6.5 V 02 POLK DCCKR 6.5 V 02 PSLK DCCKR 6.5 V 02 NOLK DCCKR 6.5 V 02 NSLK
Inductive proximity switch rectangular design								Product description
	8 x 8 x 40	2.0	f	pnp, 200 mA, NO pnp, 200 mA, NC npn, 200 mA, NO npn, 200 mA, NC	Brass nickel plated	2.0m		DCCQ 08 M 02 PSLK DCCQ 08 M 02 POLK DCCQ 08 M 02 NSLK DCCQ 08 M 02 NOLK
	8 x 8 x 50	2.0	f	pnp, 200 mA, NO pnp, 200 mA, NC npn, 200 mA, NO npn, 200 mA, NC	Brass nickel plated	M8	TK ...	DCCQ 08 M 02 PSK-TSL DCCQ 08 M 02 POK-TSL DCCQ 08 M 02 NSK-TSL DCCQ 08 M 02 NOK-TSL
	40 x 40 x 118	20.0	f	pnp, 200 mA, NO	PA	Clamps		DCCR 40 K 20 PSOL-KL
	40 x 40 x 67	20.0	f	pnp, 200 mA, NO	PA	M12	VK ...	DCCR 44 K 20 PSOL-IBS

Inductive proximity switch

3 times the switching distance Sn







- Switching distance up to 3 times longer than the standard Sn
- Longest switching distances for demanding applications

Technical data (typ.)	+20 °C, 24 VDC
Installation instructions	flush / non-flush / quasi-flush (see page 121)
For more information, visit	www.di-soric.com



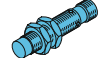
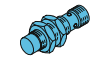

	Housing design Size (mm)	Switching distance (mm)	flush (f) / non-flush (nf)	Switching output	Housing material	Cable length; plug connector	Connection cable (optionally available)	Product description
	M8 x 48	3.0	f	pnp, 200 mA, NO	Brass nickel plated	2.0m		DCC 08 M 03 PSLK
				pnp, 200 mA, NC				DCC 08 M 03 POLK
				nnp, 200 mA, NO				DCC 08 M 03 NSLK
				nnp, 200 mA, NC				DCC 08 M 03 NOLK
	M8 x 60	3.0	f	pnp, 200 mA, NO	Brass nickel plated	M8	TK ...	DCC 08 M 03 PSK-TSL
				pnp, 200 mA, NC				DCC 08 M 03 POK-TSL
				nnp, 200 mA, NO				DCC 08 M 03 NSK-TSL
				nnp, 200 mA, NC				DCC 08 M 03 NOK-TSL
	M8 x 67	3.0	f	pnp, 200 mA, NO	Brass nickel plated	M12	VK ...	DCC 08 M 03 PSK-IBSL
				pnp, 200 mA, NC				DCC 08 M 03 POK-IBSL
				nnp, 200 mA, NO				DCC 08 M 03 NSK-IBSL
				nnp, 200 mA, NC				DCC 08 M 03 NOK-IBSL
	M8 x 45	6.0	nf	pnp, 200 mA, NO	Brass nickel plated	2.0m		DCC 08 M 06 PSLK
				pnp, 200 mA, NC				DCC 08 M 06 POLK
				nnp, 200 mA, NO				DCC 08 M 06 NSLK
				nnp, 200 mA, NC				DCC 08 M 06 NOLK
	M8 x 60	6.0	nf	pnp, 200 mA, NO	Brass nickel plated	M8	TK ...	DCC 08 M 06 PSK-TSL
				pnp, 200 mA, NC				DCC 08 M 06 POK-TSL
				nnp, 200 mA, NO				DCC 08 M 06 NSK-TSL
				nnp, 200 mA, NC				DCC 08 M 06 NOK-TSL
	M8 x 66	6.0	nf	pnp, 200 mA, NO	Brass nickel plated	M12	VK ...	DCC 08 M 06 PSK-IBSL
				pnp, 200 mA, NC				DCC 08 M 06 POK-IBSL
				nnp, 200 mA, NO				DCC 08 M 06 NSK-IBSL
				nnp, 200 mA, NC				DCC 08 M 06 NOK-IBSL

3 times the switching distance S_n



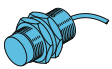
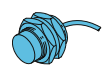

	Housing design Size (mm)	Switching distance (mm)	flush (f) / non-flush (nf)	Switching output	Housing material	Cable length, plug connector	Connection cable (optionally available)	Product description
Inductive proximity switch helical design								
	M12 x 50	10.0	nf	pnp, 200 mA, NO pnp, 200 mA, NC npn, 200 mA, NO npn, 200 mA, NC	Brass nickel plated	2.0m		DCC 12 M 10 PSLK DCC 12 M 10 POLK DCC 12 M 10 NSLK DCC 12 M 10 NOLK
	M12 x 35	10.0	nf	pnp, 200 mA, NO pnp, 200 mA, NC npn, 200 mA, NO npn, 200 mA, NC	Brass nickel plated	2.0m		DCCK 12 M 10 PSLK DCCK 12 M 10 POLK DCCK 12 M 10 NSLK DCCK 12 M 10 NOLK
	M12 x 60	10.0	nf	pnp, 200 mA, NO pnp, 200 mA, NC npn, 200 mA, NO npn, 200 mA, NC	Brass nickel plated	M12	VK...	DCC 12 M 10 PSK-IBSL DCC 12 M 10 POK-IBSL DCC 12 M 10 NSK-IBSL DCC 12 M 10 NOK-IBSL
	M12 x 45	10.0	nf	pnp, 200 mA, NO pnp, 200 mA, NC npn, 200 mA, NO npn, 200 mA, NC	Brass nickel plated	M12	VK...	DCCK 12 M 10 PSK-IBSL DCCK 12 M 10 POK-IBSL DCCK 12 M 10 NSK-IBSL DCCK 12 M 10 NOK-IBSL
	M18 x 50	20.0	nf	pnp, 200 mA, NO pnp, 200 mA, NC npn, 200 mA, NO npn, 200 mA, NC	Brass nickel plated	2.0m		DCC 18 M 20 PSLK DCC 18 M 20 POLK DCC 18 M 20 NSLK DCC 18 M 20 NOLK
	M18 x 35	20.0	nf	pnp, 200 mA, NO pnp, 200 mA, NC npn, 200 mA, NO npn, 200 mA, NC	Brass nickel plated	2.0m		DCCK 18 M 20 PSLK DCCK 18 M 20 POLK DCCK 18 M 20 NSLK DCCK 18 M 20 NOLK
	M18 x 64	20.0	nf	pnp, 200 mA, NO pnp, 200 mA, NC npn, 200 mA, NO npn, 200 mA, NC	Brass nickel plated	M12	VK...	DCC 18 M 20 PSK-IBSL DCC 18 M 20 POK-IBSL DCC 18 M 20 NSK-IBSL DCC 18 M 20 NOK-IBSL
	M18 x 49	20.0	nf	pnp, 200 mA, NO pnp, 200 mA, NC npn, 200 mA, NO npn, 200 mA, NC	Brass nickel plated	M12	VK...	DCCK 18 M 20 PSK-IBSL DCCK 18 M 20 POK-IBSL DCCK 18 M 20 NSK-IBSL DCCK 18 M 20 NOK-IBSL

Inductive proximity switch

3 times the switching distance S_n

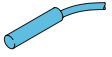
	Housing design Size (mm)	Switching distance (mm)	flush (f) / non-flush (nf)	Switching output	Housing material	Cable length, plug connector	Connection cable (optionally available)	
Inductive proximity switch helical design								
	M30 x 60	40.0	nf	pnp, 200 mA, NO	Brass nickel plated	2.0m		DCC 30 M 40 PSLK
				pnp, 200 mA, NC				DCC 30 M 40 POLK
				npn, 200 mA, NO				DCC 30 M 40 NSLK
				npn, 200 mA, NC				DCC 30 M 40 NOLK
	M30 x 35	40.0	nf	pnp, 200 mA, NO	Brass nickel plated	2.0m		DCCK 30 M 40 PSLK
				pnp, 200 mA, NC				DCCK 30 M 40 POLK
				npn, 200 mA, NO				DCCK 30 M 40 NSLK
				npn, 200 mA, NC				DCCK 30 M 40 NOLK
	M30 x 74	40.0	nf	pnp, 200 mA, NO	Brass nickel plated	M12	VK...	DCC 30 M 40 PSK-IBSL
				pnp, 200 mA, NC				DCC 30 M 40 POK-IBSL
				npn, 200 mA, NO				DCC 30 M 40 NSK-IBSL
				npn, 200 mA, NC				DCC 30 M 40 NOK-IBSL
	M30 x 49	40.0	nf	pnp, 200 mA, NO	Brass nickel plated	M12	VK...	DCCK 30 M 40 PSK-IBSL
				pnp, 200 mA, NC				DCCK 30 M 40 POK-IBSL
				npn, 200 mA, NO				DCCK 30 M 40 NSK-IBSL
				npn, 200 mA, NC				DCCK 30 M 40 NOK-IBSL

3 times the switching distance S_n

	Housing design Size (mm)	Switching distance (mm)	flush (f) / non-flush (nf)	Switching output	Housing material	Cable length, plug connector	Connection cable (optionally available)	
Inductive proximity switch cylindrical design								Product description
	Ø 6.5x48	3.0	f	pnp, 200 mA, NO	Brass nickel plated	2.0m		DCC 6.5 M 03 PSLK
				pnp, 200 mA, NC				DCC 6.5 M 03 POLK
				nnp, 200 mA, NO				DCC 6.5 M 03 NSLK
				nnp, 200 mA, NC				DCC 6.5 M 03 NOLK
	Ø 6.5x60	3.0	f	pnp, 200 mA, NO	Brass nickel plated	M8	TK...	DCC 6.5 M 03 PSK-TSL
				pnp, 200 mA, NC				DCC 6.5 M 03 POK-TSL
				nnp, 200 mA, NO				DCC 6.5 M 03 NSK-TSL
				nnp, 200 mA, NC				DCC 6.5 M 03 NOK-TSL
Inductive proximity switch rectangular design								Product description
	40 x 40 x 118	40.0	nf	pnp, 200 mA, antivalent	PA	Clamps		DCCR 40 K 40 PSOL-KL
	40 x 40 x 67	40.0	nf	pnp, 200 mA, antivalent	PA	M12	VK...	DCCR 44 K 40 PSOL-IBS

Inductive proximity switch

Solid metal









- Closed, all-steel sleeve
- Switching distance 2 to 3 times longer than the standard Sn
- Particularly robust design
- Pressure-resistant up to 100 bar

Technical data (typ.)	+20 °C, 24 VDC
Installation instructions	flush / non-flush / quasi-flush (see page 121)
For more information, visit	www.di-soric.com











	Housing design Size (mm)	Switching distance (mm)	flush (f) / non-flush (nf)	Switching output	Housing material	Protection type	Cable length, plug connector	Connection cable (optionally available)	Product description
	M8 x 45	2.0	f	pnp, 200 mA, NO	V2A	IP 68	2.0m		D7B 08 VB 02 PS-3
				npn, 200 mA, NO					D7B 08 VB 02 NS-3
	M8 x 60	2.0	f	pnp, 200 mA, NO	V2A	IP 68	M8	TK...	D7B 08 VB 02 PS-T3
				npn, 200 mA, NO					D7B 08 VB 02 NS-T3
	M8 x 45	3.0	f	pnp, 200 mA, NO	V2A	IP 68 IP69K	2.0m		D7C 08 V 03 PSLK
				pnp, 200 mA, NO					D7C 08 V 03 NSLK
	M8 x 60	3.0	f	pnp, 200 mA, NO	V2A	IP 67	M8	TK...	D7C 08 V 03 PSK-TSL
				pnp, 200 mA, NO					D7C 08 V 03 NSK-TSL
	M8 x 66	3.0	f	pnp, 200 mA, NO	V2A	IP 67	M12	VK...	D7C 08 V 03 PSK-IBSL
				pnp, 200 mA, NC					D7C 08 V 03 POK-IBSL
				npn, 200 mA, NO					D7C 08 V 03 NSK-IBSL
				npn, 200 mA, NC					D7C 08 V 03 NOK-IBSL
	M8 x 45	6.0	nf	pnp, 200 mA, NO	V2A	IP 68	2.0m		D7C 08 V 06 PSLK
				npn, 200 mA, NO					D7C 08 V 06 NSLK

Solid metal







	Housing design Size (mm)	Switching distance (mm)	flush (f) / non-flush (nf)	Switching output	Housing material	Protection type	Cable length, plug connector	Connection cable (optionally available)	Product description
Inductive proximity switch helical design									
	M8 x 45	6.0	nf	pnp, 200 mA, NO pnp, 200 mA, NC	V2A	IP 67	M8	TK ...	D7C 08 V 06 PSK-TSL D7C 08 V 06 POK-TSL
	M8 x 66	6.0	nf	pnp, 200 mA, NO pnp, 200 mA, NC npn, 200 mA, NO npn, 200 mA, NC	V2A	IP 67	M12	VK ...	D7C 08 V 06 PSK-IBSL D7C 08 V 06 POK-IBSL D7C 08 V 06 NSK-IBSL D7C 08 V 06 NOK-IBSL
	M12 x 50	3.0	f	pnp, 200 mA, NO npn, 200 mA, NO	V2A	IP 68/IP 69K	2.0m		D7B 12 V 03 PS-3 D7B 12 V 03 NS-3
	M12 x 60	3.0	f	pnp, 200 mA, NO npn, 200 mA, NO	V2A	IP 68/IP 69K	M12	VK ...	D7B 12 V 03 PS-B3 D7B 12 V 03 NS-B3
	M12 x 50	6.0	f	pnp, 200 mA, NO pnp, 200 mA, NC npn, 200 mA, NO npn, 200 mA, NC	V2A	IP 69K	2.0m		D7C 12 V 06 PSLK D7C 12 V 06 POLK D7C 12 V 06 NSLK D7C 12 V 06 NOLK
	M12 x 60	6.0	f	pnp, 200 mA, NO pnp, 200 mA, NC npn, 200 mA, NO npn, 200 mA, NC	V2A	IP 68	M12	VK ...	D7C 12 V 06 PSK-IBSL D7C 12 V 06 POK-IBSL D7C 12 V 06 NSK-IBSL D7C 12 V 06 NOK-IBSL
	M12 x 50	10.0	nf	pnp, 200 mA, NO pnp, 200 mA, NC npn, 200 mA, NO npn, 200 mA, NC	V2A	IP 69K	2.0m		D7C 12 V 10 PSLK D7C 12 V 10 POLK D7C 12 V 10 NSLK D7C 12 V 10 NOLK
	M12 x 60	10.0	nf	pnp, 200 mA, NO pnp, 200 mA, NC npn, 200 mA, NO npn, 200 mA, NC	V2A	IP 68	M12	VK ...	D7C 12 V 10 PSK-IBSL D7C 12 V 10 POK-IBSL D7C 12 V 10 NSK-IBSL D7C 12 V 10 NOK-IBSL

Inductive proximity switch

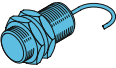
Solid metal

	Housing design Size (mm)	Switching distance (mm)	flush (f) / non-flush (nf)	Switching output	Housing material	Protection type	Cable length, plug connector	Connection cable (optionally available)	
Inductive proximity switch helical design									Product description
	M18 x 51	5.0	f	pnp, 200 mA, NO npn, 200 mA, NO	V2A	IP 68/ IP 69K	2.0m		D7B 18 VB 05 PS-3 D7B 18 VB 05 NS-3
	M18 x 64	5.0	f	pnp, 200 mA, NO npn, 200 mA, NO	V2A	IP 68/ IP 69K	2.0m		D7B 18 VB 05 PS-B3 D7B 18 VB 05 NS-B3
	M18 x 50	8.0	nf	pnp, 200 mA, NO npn, 200 mA, NO	V2A	IP 69K	2.0m		D7C 18 V 08 PSLK D7C 18 V 08 NSLK
	M18 x 64	8.0	nf	pnp, 200 mA, NO npn, 200 mA, NO	V2A	IP 68	M12	VK ...	D7C 18 V 08 PSK-IBSL D7C 18 V 08 NSK-IBSL
	M18 x 50	10.0	f	pnp, 200 mA, NO pnp, 200 mA, NC npn, 200 mA, NO npn, 200 mA, NC	V2A	IP 69K	2.0m		D7C 18 V 10 PSLK D7C 18 V 10 POLK D7C 18 V 10 NSLK D7C 18 V 10 NOLK
	M18 x 64	10.0	f	pnp, 200 mA, NO pnp, 200 mA, NC npn, 200 mA, NO npn, 200 mA, NC	V2A	IP 68	M12	VK ...	D7C 18 V 10 PSK-IBSL D7C 18 V 10 POK-IBSL D7C 18 V 10 NOK-IBSL D7C 18 V 10 NSK-IBSL
	M18 x 50	20.0	nf	pnp, 200 mA, NO pnp, 200 mA, NC npn, 200 mA, NO npn, 200 mA, NC	V2A	IP 69K	2.0m		D7C 18 V 20 PSLK D7C 18 V 20 POLK D7C 18 V 20 NSLK D7C 18 V 20 NOLK
	M18 x 64	20.0	nf	pnp, 200 mA, NO pnp, 200 mA, NC npn, 200 mA, NO npn, 200 mA, NC	V2A	IP 68	M12	VK ...	D7C 18 V 20 PSK-IBSL D7C 18 V 20 POK-IBSL D7C 18 V 20 NSK-IBSL D7C 18 V 20 NOK-IBSL

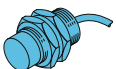
Solid metal

	Housing design Size (mm)	Switching distance (mm)	flush (f) / non-flush (nf)	Switching output	Housing material	Protection type	Cable length, plug connector	Connection cable (optionally available)	Product description
Inductive proximity switch helical design									
	M30 x 50	10.0	f	pnp, 200 mA, NO pnp, 200 mA, NC	V2A	IP 68/ IP 69K	2.0m		D7B 30 VB 10 PS-3 D7B 30 VB 10 NS-3
	M30 x 65	10.0	f	pnp, 200 mA, NO pnp, 200 mA, NC	V2A	IP 68/ IP 69K	M12	VK ...	D7B 30 VB 10 PS-B3 D7B 30 VB 10 NS-B3
	M30 x 50	20.0	f	pnp, 200 mA, NO pnp, 200 mA, NC	V2A	IP 69K	2.0m		D7C 30 V 20 PSLK D7C 30 V 20 POLK
	M30 x 64	20.0	f	pnp, 200 mA, NO pnp, 200 mA, NC npn, 200 mA, NO npn, 200 mA, NC	V2A	IP 68	M12	VK ...	D7C 30 V 20 PSK-IBSL D7C 30 V 20 POK-IBSL D7C 30 V 20 NSK-IBSL D7C 30 V 20 NOK-IBSL
	M30 x 50	40.0	nf	pnp, 200 mA, NO pnp, 200 mA, NC npn, 200 mA, NO npn, 200 mA, NC	V2A	IP 69K	2.0m		D7C 30 V 40 PSLK D7C 30 V 40 POLK D7C 30 V 40 NSLK D7C 30 V 40 NOLK
	M30 x 64	40.0	nf	pnp, 200 mA, NO pnp, 200 mA, NC npn, 200 mA, NO npn, 200 mA, NC	V2A	IP 68	M12	VK ...	D7C 30 V 40 PSK-IBSL D7C 30 V 40 POK-IBSL D7C 30 V 40 NSK-IBSL D7C 30 V 40 NOK-IBSL













Inductive proximity switch

Analog output

- Analog current output/voltage output
- For distance measurement of metallic targets
- Maximum switching distances

Technical data (typ.)	+20 °C, 24 VDC
Installation instructions	flush / non-flush / quasi-flush (see page 121)
For more information, visit	www.di-soric.com



Housing design Size (mm)	Switching distance (mm)	flush (f) / non-flush (nf) / quasi-flush (qf)	Analog output	Housing material	Protection type	Cable length, plug connector	Connection cable (optionally available)	Product description
Inductive proximity switch helical design								
	M8 x 45					2.0m		DCC 08 M 04/10 AK
	M8 x 60	0 to 4	quasi-flush	0 to 10 V	Brass nickel plated	IP 67	M8	TK ... DCC 08 M 04/10 AK-TSL
	M8 x 66						M12	VK ... DCC 08 M 04/10 AK-IBS
	M12 x 50	0 to 6	quasi-flush	0 to 10 V, 4 to 20 mA	Brass nickel plated	IP 67	2.0m	DCC 12 M 06/10 AIK
	M12 x 60						M12	VK ... DCC 12 M 06/10 AIK-IBS
	M12 x 35	0 to 6	quasi-flush	0 to 10 V	Brass nickel plated	IP 67	2.0m	DCCK 12 M 06/10 AK
	M12 x 45						M12	VK ... DCCK 12 M 06/10 AK-IBS
	M18x50	0 to 10	quasi-flush	0 to 10 V, 4 to 20 mA	Brass nickel plated	IP 67	2.0m	DCC 18 M 10/10 AIK
	M18x64						M12	VK ... DCC 18 M 10/10 AIK-IBS
	M18 x 64	0 to 20	nf	0 to 10 V, 4 to 20 mA	Brass nickel plated	IP 67	M12	VK ... DCC 18 M 20/10 AIK-IBS
	M18x35	0 to 10	quasi-flush	0 to 10 V, 4 to 20 mA	Brass nickel plated	IP 67	2.0m	DCCK 18 M 10/10 AIK
	M18x49						M12	VK ... DCCK 18 M 10/10 AIK-IBS

Analog output

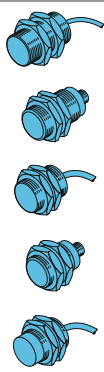
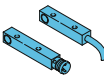
	Housing design Size (mm)	Switching distance (mm)	flush (f) / non-flush (nf) / quasi-flush (qf)	Analog output	Housing material	Protection type	Cable length, plug connector	Connection cable (optionally available)	
Inductive proximity switch helical design									Product description
	M30 x 60	0 to 20	quasi-flush	0 to 10 V, 4 to 20 mA	Brass nickel plated	IP 67	2.0m		DCC 30 M 20/10 AIK
	M30 x 74						M12	VK ...	DCC 30 M 20/10 AIK-IBS
	M30 x 35	0 to 20	quasi-flush	0 to 10 V, 4 to 20 mA	Brass nickel plated	IP 67	2.0m		DCCK 30 M 20/10 AIK
	M30 x 49						M12	VK ...	DCCK 30 M 20/10 AIK-IBS
	M30x35	0 to 40	nf	0 to 10 V, 4 to 20 mA	Brass nickel plated	IP 67	2.0m		DCCK 30 M 40/10 AIK
Inductive proximity switch rectangular design									Product description
	8 x 8 x 50	0 to 4	quasi-flush	0 to 10 V	Brass nickel plated	IP 67	2.0m		DCCQ 08 M 04/10 AK
							M8	TK ...	DCCQ 08 M 04/10 AK-TSL



Inductive proximity switch

Universal voltage

- Service voltage 20 to 250 VAC, 10 to 250 VDC
- Protection class IP 67

Technical data (typ.)	+20 °C, 24 VDC
Installation instructions	flush / non-flush / quasi-flush (see page 121)
For more information, visit	www.di-soric.com

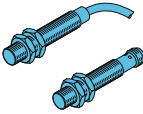
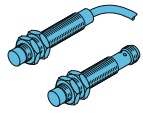
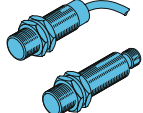
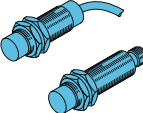
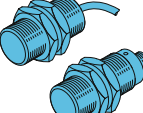











Housing design Size (mm)	Switching distance (mm)	flush (f) / non-flush (nf)	Switching output	Housing material	Protection type	Cable length, plug connector	Connection cable (optionally available)	Product description
Inductive proximity switch helical design								
	M12 x 70	2.0	f	UC, 300mA, NO UC, 300mA, NC	Brass nickel plated	IP 67	2.0m	UCC 12 M 02 SL UCC 12 M 02 OL
	M12 x 75	2.0	f	UC, 300mA, NO UC, 300mA, NC	Brass nickel plated	IP 67	M12 VK ...	UCC 12 M 02 S-IBSL UCC 12 M 02 O-IBSL
	M12 x 70	4.0	nf	UC, 300mA, NO UC, 300mA, NC	Brass nickel plated	IP 67	2.0m	UCC 12 M 04 SL UCC 12 M 04 OL
	M12 x 75	4.0	nf	UC, 300mA, NO UC, 300mA, NC	Brass nickel plated	IP 67	M12 VK ...	UCC 12 M 04 S-IBSL UCC 12 M 04 O-IBSL
	M18 x 60	5.0	f	UC, 300mA, NO UC, 300mA, NC	Brass nickel plated	IP 67	2.0m	UCC 18 M 05 SL UCC 18 M 05 OL
	M18 x 80	5.0	f	UC, 300mA, NO UC, 300mA, NC	Brass nickel plated	IP 67	M12 VK ...	UCC 18 M 05 S-IBSL UCC 18 M 05 O-IBSL
	M18 x 60	8.0	nf	UC, 300mA, NO UC, 300mA, NC	Brass nickel plated	IP 67	2.0m	UCC 18 M 08 SL UCC 18 M 08 OL
	M18 x 80	8.0	nf	UC, 300mA, NO UC, 300mA, NC	Brass nickel plated	IP 67	M12 VK ...	UCC 18 M 08 S-IBSL UCC 18 M 08 O-IBSL
	M30 x 60	10.0	f	UC, 300mA, NO UC, 300mA, NC	Brass nickel plated	IP 67	2.0m	UCC 30 M 10 SL UCC 30 M 10 OL
	M30 x 80	10.0	f	UC, 300mA, NO UC, 300mA, NC	Brass nickel plated	IP 67	M12 VK ...	UCC 30 M 10 S-IBSL UCC 30 M 10 O-IBSL
	M30 x 60	15.0	nf	UC, 300mA, NO UC, 300mA, NC	Brass nickel plated	IP 67	2.0m	UCC 30 M 15 SL UCC 30 M 15 OL
Inductive proximity switch rectangular design								
	120 x 40 x 40	20.0	f	UC, 300mA, NO or NC	PA 6.6	IP 67	Clamps	UCCR 40 K 20 S0-KL

High-temperature resistant

- High-temperature resistant version (sometimes with an external amplifier)
- Permanent temperature up to 230 °C





Technical data (typ.)	+20 °C, 24 VDC
Installation instructions	flush / non-flush / quasi-flush (see page 121)
For more information, visit	www.di-soric.com



	Housing design Size (mm)	Switching distance (mm)	flush (f) / non-flush (nf) / quasi-flush (qf)	Temperature range (°C)	Switching output	Housing material	Protection type	Cable length, plug connector	Product description
Inductive proximity switch helical design									
	M8x55	2.0	f	0 to +140	pnp, 120 mA, NO nnp, 120 mA, NO	V2A LCP	IP 65	2.0m	DCC 08 VH 02 PSK/140 DCC 08 VH 02 NSK/140
	M12x63	2.0	f	-25 to +120	pnp, 200 mA, NO	V4A Plastic	IP 65	2.0m	DCE 12 VH 02 PSK
	M12x56	3.0	f	0 to +150	pnp, 120 mA, NO nnp, 120 mA, NO	V2A LCP	IP 65	2.0m	DCC 12 VH 03 PSK/150 DCC 12 VH 03 NSK/150
	M12x63	4.0	nf	-25 to +120	pnp, 200 mA, NO	V4A Plastic	IP 68	2.0m	DCE 12 VH 04 PSK
	M18x80	5.0	f	-25 to +120	pnp, 200 mA, NO	V4A Plastic	IP 65	2.0m	DCE 18 VH 05 PSK
	M18x67	5.0	f	-25 to +120	pnp, 200 mA, NO	V4A Plastic	IP 68	2.0m	DCE 18 VH 05 PSLK
	M18x70	5.0	f	0 to +180	pnp, 200 mA, NO	V2A LCP	IP 65	2.0m	DCC 18 VH 05 PSK/180
	M18x70	5.0	f	0 to +180	pnp, 150 mA, NO	V2A LCP	IP 65	2.0m	DCC 18 VH 05 NSK/180
	M18x70	5.0	f	0 to +230 (sensor)	nnp, 200 mA, NO	V2A LCP	IP 65	2.0m	DCC 18 VH 05 NSK/230/V
	M18x67	7.0	nf	-25 to +120	pnp, 200 mA, NO	V4A Plastic	IP 68	2.0m	DCE 18 VH 07 PSLK
	M18x77	8.0	nf	0 to +180	pnp, 150 mA, NO nnp, 150 mA, NO	V2A LCP	IP 65	2.0m	DCC 18 VH 08 PSK/180 DCC 18 VH 08 NSK/180
	M30 x 85	10.0	f	-25 to +160	pnp, 200 mA, NO	V4A Plastic	IP 65	2.0m	DCE 30 VH 10 PSK
					pnp, 150 mA, NO				DCC 30 VH 10 PSK/180
	M30 x 75	10.0	f	0 to +180	pnp, 150 mA, NC nnp, 150 mA, NO	V2A LCP	IP 65	2.0m	DCC 30 VH 10 POK/180 DCC 30 VH 10 NSK/180

Inductive proximity switch

High-temperature resistant



	Housing design Size (mm)	Switching distance (mm)	flush (f) / non-flush (nf) / quasi-flush (qf)	Temperature range (°C)	Switching output	Housing material	Protection type	Cable length, plug connector	
Inductive proximity switch helical design									Product description
	M30 x 75	10.0	f	0 to +230 (sensor)	pnp, 200 mA, NO nnp, 200 mA, NO	Stainless steel LCP	IP 65	2.0m	DCC 30 VH 10 PSK/230/V DCC 30 VH 10 NSK/230/V
	M30 x 83	15.0	nf	0 to +180	pnp, 150 mA, NO nnp, 150 mA, NO	Stainless steel LCP	IP 65	2.0m	DCC 30 VH 15 PSK/180 DCC 30 VH 15 NSK/180
	M30 x 83	15.0	nf	0 to +230 (sensor)	pnp, 200 mA, NO nnp, 200 mA, NO	Stainless steel LCP	IP 65	2.0m	DCC 30 VH 15 PSK/230/V DCC 30 VH 15 NSK/230/V
	M50 x 89	25.0	nf	0 to +180	pnp, 150 mA, NO nnp, 150 mA, NO	Stainless steel LCP	IP 65	2.0m	DCC 50 VH 25 PSK/180 DCC 50 VH 25 NSK/180
	M50 x 68	25.0	nf	0 to +230 (sensor)	pnp, 200 mA, NO nnp, 200 mA, NO	Stainless steel LCP	IP 65	2.0m	DCC 50 VH 25 PSK/230/V DCC 50 VH 25 NSK/230/V

Low-temperature resistant

- Low-temperature resistant version down to a permanent temperature of -55 °C
- Protection class IP 68 and IP 69K (water-jet resistant)
- Stainless steel housing
- Sensing surface PTFE

Technical data (typ.)	+20 °C, 24 VDC
Service voltage	10 to 33 V DC
Ambient temperature	-55 to +60 °C
Insulation voltage endurance	500V
Installation instructions	flush / non-flush / quasi-flush (see page 121)













	Housing design Size (mm)	Switching distance (mm)	flush (f) / non-flush (nf) / quasi-flush (qf)	Temperature range (°C)	Switching output	Housing material	Protection type	Cable length, plug connector	
Inductive proximity switch helical design									Product description
	M12 x 63	2.0 4.0	f nf	-55 to +60	pnp, 200 mA, NO	1.4571 PTFE	IP 68 (IP 69K)	2.0m	DCE 12 VT 02 PSK DCE 12 VT 04 PSK
	M18 x 67	5.0 7.0	f nf	-55 to +60	pnp, 200 mA, NO	1.4571 PTFE	IP 68 (IP 69K)	2.0m	DCE 18 VT 05 PSLK DCE 18 VT 07 PSLK

High-pressure resistant

- High-pressure resistant version up to 500 bar
- Stainless steel housing

Technical data (typ.)	+20 °C, 24 VDC
Pressure-resistant up to	500 bar
Assembly	flush
Service voltage	10 to 30 V DC
Ambient temperature	-25 to +100 °C (DCC 12...)
	-25 to +80 °C (DCC 14...)
Installation instructions	flush / non-flush / quasi-flush (see page 121)



	Housing design Size (mm)	Switching distance (mm)	Switching output	Housing material	Protection type	Cable length, plug connector	Connection cable (optionally available)	
Inductive proximity switch helical design								Product description
	M12 x 56	2.0	pnp, 200mA, NO	V2A	IP 68 / IP 69	M12	VK ...	DCC 12 VHD 2 PS-B3-56-4
	M12 x 56	2.0	pnp, 200mA, NO	V2A	IP 68 / IP 69	M12	VK ...	DCC 12 VHD 2 PS-B3-56-7
	M12 x 69	2.0	pnp, 200mA, NO	V2A	IP 68 / IP 69	M12	VK ...	DCC 12 VHD 2 PS-B3-69-2
	M12 x 69	2.0	pnp, 200mA, NC	V2A	IP 68 / IP 69	M12	VK ...	DCC 12 VHD 2 PO-B3-69-2
	M12 x 78	2.0	pnp, 200mA, NO	V2A	IP 68 / IP 69	M12	VK ...	DCC 12 VHD 2 PS-B3-78-7
	M12 x 93	2.0	pnp, 200mA, NO	V2A	IP 68 / IP 69	M12	VK ...	DCC 12 VHD 2 PS-B3-93-2
	M12 x 98	2.0	pnp, 200mA, NO	V2A	IP 68 / IP 69	M12	VK ...	DCC 12 VHD 2 PS-B3-98-7
	M12 x 127	2.0	pnp, 200mA, NO	V2A	IP 68 / IP 69	M12	VK ...	DCC 12 VHD 2 PS-B3-127-2
	M14 x 65	3.0	pnp, 200mA, NO	V2A ZrO2 ceramic	IP 68	M12	VK ...	DCC 14 V 03 PSK 500-IBS
	M14 x 65	3.0	nnp, 200mA, NO		IP 68	M12	VK ...	DCC 14 V 03 NSK 500-IBS
	M14 x 57	3.0	pnp, 200mA, NO		IP 68	2.0m PUR		DCC 14 V 03 PSK 500

Inductive proximity switch

Food and beverage





- For the food industry
- For saltwater applications
- Large switching distance to steel and aluminum
- Closed, all-steel sleeve

Technical data (typ.)	+20 °C, 24 VDC
Service voltage	10 to 30 V DC
Ambient temperature	-25 to +85 °C
Installation instructions	flush / non-flush / quasi-flush (see page 121)

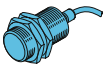

Inductive proximity switch helical design								Product description
Housing design Size (mm)	Switching distance (mm)	flush (f) non-flush (nf)	Switching output	Housing material	Protection type	Cable length, plug connector	Connection cable (optionally available)	
	M12 x 69	6.0	f	pnp, 200 mA, NO	1.4435	IP 68/IP 69K	2.0m	DCC 12 VL 06 PSLK
				pnp, 200 mA, NC				DCC 12 VL 06 POLK
				npn, 200 mA, NO				DCC 12 VL 06 NSLK
				npn, 200 mA, NC				DCC 12 VL 06 NOLK
	M12 x 60	6.0	f	pnp, 200 mA, NO	1.4435	IP 68/IP 69K	M12	VK ...
				pnp, 200 mA, NC				DCC 12 VL 06 PSK-IBSL
				npn, 200 mA, NO				DCC 12 VL 06 POK-IBSL
				npn, 200 mA, NC				DCC 12 VL 06 NSK-IBSL
	M12 x 69	10.0	nf	pnp, 200 mA, NO	1.4435	IP 68/IP 69K	2.0m	DCC 12 VL 10 PSLK
				pnp, 200 mA, NC				DCC 12 VL 10 POLK
				npn, 200 mA, NO				DCC 12 VL 10 NSLK
				npn, 200 mA, NC				DCC 12 VL 10 NOLK
	M12 x 60	10.0	nf	pnp, 200 mA, NO	1.4435	IP 68/IP 69K	M12	VK ...
				pnp, 200 mA, NC				DCC 12 VL 10 PSK-IBSL
				npn, 200 mA, NO				DCC 12 VL 10 POK-IBSL
				npn, 200 mA, NC				DCC 12 VL 10 NSK-IBSL
	M18 x 70	10.0	f	pnp, 200 mA, NO	1.4435	IP 68/IP 69K	2.0m	DCC 18 VL 10 PSLK
				pnp, 200 mA, NC				DCC 18 VL 10 POLK
				npn, 200 mA, NO				DCC 18 VL 10 NSLK
				npn, 200 mA, NC				DCC 18 VL 10 NOLK
	M18 x 64	10.0	f	pnp, 200 mA, NO	1.4435	IP 68/IP 69K	M12	VK ...
				pnp, 200 mA, NC				DCC 18 VL 10 PSK-IBSL
				npn, 200 mA, NO				DCC 18 VL 10 POK-IBSL
				npn, 200 mA, NC				DCC 18 VL 10 NSK-IBSL
	M18 x 70	20.0	nf	pnp, 200 mA, NO	1.4435	IP 68/IP 69K	2.0m	DCC 18 VL 20 PSLK
				pnp, 200 mA, NC				DCC 18 VL 20 POLK
				npn, 200 mA, NO				DCC 18 VL 20 NSLK
				npn, 200 mA, NC				DCC 18 VL 20 NOLK
	M18 x 64	20.0	nf	pnp, 200 mA, NO	1.4435	IP 68/IP 69K	M12	VK ...
				pnp, 200 mA, NC				DCC 18 VL 20 PSK-IBSL
				npn, 200 mA, NO				DCC 18 VL 20 POK-IBSL
				npn, 200 mA, NC				DCC 18 VL 20 NSK-IBSL

Food and beverage

	Housing design Size (mm)	Switching distance (mm)	flush (f) non-flush (nf)	Switching output	Housing material	Protection type	Cable length, plug connector	Connection cable (optionally available)	
Inductive proximity switch helical design									Product description
	M30 x 70	20.0	f	pnp, 200 mA, NO pnp, 200 mA, NC npn, 200 mA, NO npn, 200 mA, NC	1.4435	IP 68/IP 69K	2.0m		DCC 30 VL 20 PSLK DCC 30 VL 20 POLK DCC 30 VL 20 NSLK DCC 30 VL 20 NOLK
	M30 x 64	20.0	f	pnp, 200 mA, NO pnp, 200 mA, NC npn, 200 mA, NO npn, 200 mA, NC	1.4435	IP 68/IP 69K	M12	VK ...	DCC 30 VL 20 PSK-IBSL DCC 30 VL 20 POK-IBSL DCC 30 VL 20 NSK-IBSL DCC 30 VL 20 NOK-IBSL
	M30 x 70	40.0	nf	pnp, 200 mA, NO pnp, 200 mA, NC npn, 200 mA, NO npn, 200 mA, NC	1.4435	IP 68/IP 69K	2.0m		DCC 30 VL 40 PSLK DCC 30 VL 40 POLK DCC 30 VL 40 NSLK DCC 30 VL 40 NOLK
	M30 x 64	40.0	nf	pnp, 200 mA, NO pnp, 200 mA, NC npn, 200 mA, NO npn, 200 mA, NC	1.4435	IP 68/IP 69K	M12	VK ...	DCC 30 VL 40 PSK-IBSL DCC 30 VL 40 POK-IBSL DCC 30 VL 40 NSK-IBSL DCC 30 VL 40 NOK-IBSL

Capacitive proximity switch

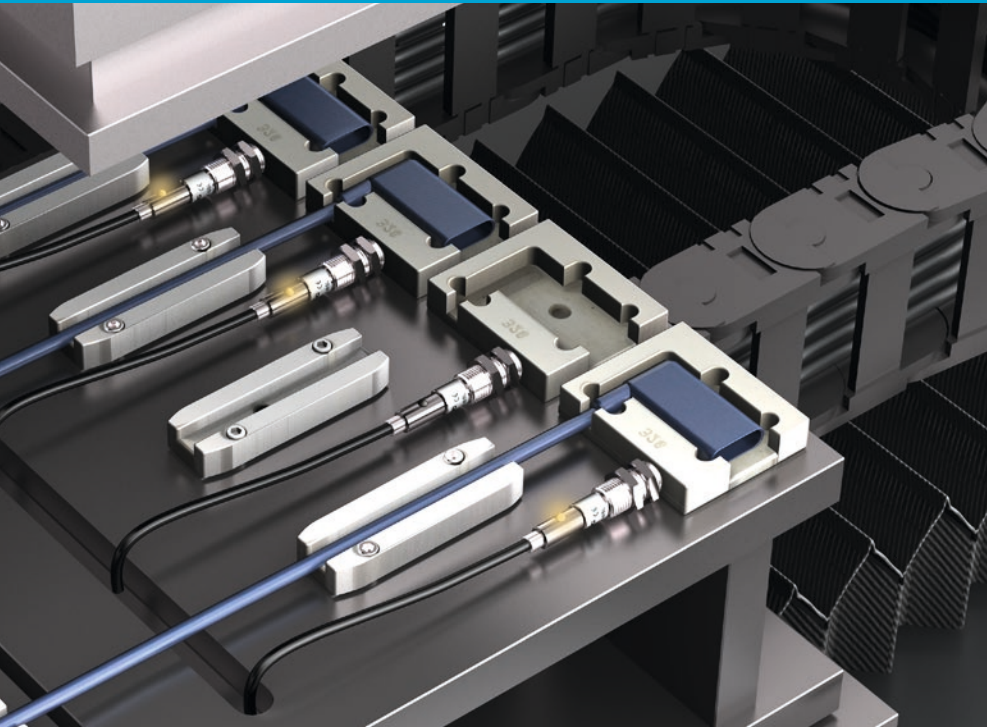





Capacitive proximity switches





Capacitive proximity switches detect both metallic and non-metallic materials. A wide variety of different shapes and designs provides versatile options for use.

- Detection of:
liquid, powdered, solid, electrically conductive and non-conductive materials
- Potentiometer and teach variants
- Switching distances can be set up to 30 mm
- Designs Ø6.5 mm up to M30
- Panel design Ø50x10 mm









Housing design Size (mm)	Switching distance (mm)	flush (f) / non-flush (nf)	Switching output	Service voltage	Ambient temperature	Protection type	Housing material	Cable material/length, Plug connector	Connection cable (optionally available)	
-----------------------------	-------------------------	----------------------------	------------------	-----------------	---------------------	-----------------	------------------	--	--	--

Capacitive proximity switch cylindrical design										Product description	
	Ø6.5x52	2.0 (0.1 to 3.0)	f	Push-pull, 100 mA, NO/NC	18 to 30	-25 to +70	IP 67	V2A	2m		KNS D6.5M 02B G3-2R
	Ø6.5x60								M8	TK ...	KNS D6.5M 02B G3-T3
	Ø6.5x52	3.0 (0.1 to 4.0)	nf	Push-pull, 100 mA, NO/NC	18 to 30	-25 to +70	IP 67	V2A	2m		KNS D6.5M 03N G3-2R
	Ø6.5x60								M8	TK ...	KNS D6.5M 03N G3-T3
	Ø6.5x55	2.0 (0.1 to 3.0)	f	Push-pull, 150 mA, NO/NC	18 to 30	-25 to +70	IP 65	V2A	2 m/PUR	TK ...	KDCT 6.5 V 02 G3-3
										TK ... /4	KDCT 6.5 V 02 G3-4
	Ø6.5x60	2.0 (0.1 to 3.0)	f	Push-pull, 150 mA, NO/NC	18 to 30	-25 to +70	IP 65	V2A	M8	TK ...	KDCT 6.5 V 02 G3-T3
										TK ... /4	KDCT 6.5 V 02 G3-T4

Capacitive proximity switch helical design											
	M8 x 52	2.0 (0.1 to 3.0)	f	Push-pull, 100 mA, NO/NC	18 to 30	-25 to +70	IP 67	V2A	2m		KNS M8M 02B G3-2R
	M8 x 60								M8	TK ...	KNS M8M 02B G3-T3
	M8 x 52	3.0 (0.1 to 4.0)	nf	Push-pull, 100 mA, NO/NC	18 to 30	-25 to +70	IP 67	V2A	2m		KNS M8M 03N G3-2R
	M8 x 60								M8	TK ...	KNS M8M 03N G3-T3
	M8 x 52	2.0 (0.1 to 3.0)	f	Push-pull, 150 mA, NO/NC	18 to 30	-25 to +70	IP 65	V2A	2 m/PUR	3-core	KDCT 08 V 02 G3-3
										4-core	KDCT 08 V 02 G3-4
	M8 x 60	2.0 (0.1 to 3.0)	f	Push-pull, 150 mA, NO/NC	18 to 30	-25 to +70	IP 65	V2A	M8	TK ...	KDCT 08 V 02 G3-T3
										TK ... /4	KDCT 08 V 02 G3-T4
	M8 x 60	3.0 (0.1 to 4.0)	nf	Push-pull, 150 mA, NO/NC	18 to 30	-25 to +70	IP 65	V2A	M8	TK ...	KDCT 08 V 03 G3-T3
										TK ... /4	KDCT 08 V 03 G3-T4

Capacitive proximity switch

Capacitive proximity switches

	Housing design Size (mm)	Switching distance (mm)	flush (f) / non-flush (nf)	Switching output	Service voltage	Ambient temperature	Protection type	Housing material	Cable material/length, Plug connector	Connection cable (optionally available)	
Capacitive proximity switch helical design											Product description
	M12 x 55	4.0 (0.1 to 8.0)	f	Push-pull, 100 mA, NO/NC	18 to 30	-20 to +70	IP 65 IP 67	VA	2 m	VK ...	KNS M12M 04B G3-2R
	M12 x 60										KNS M12M 04B G3-B3
	M12 x 55	4.0 (0.1 to 6.0)	f	Push-pull, 150 mA, NO/NC	18 to 30	-25 to +70	IP 65	V2A	2 m, PUR	VK ...	KDCT 12 V 04 G3-4
	M12 x 60										KDCT 12 V 04 G3-B4
	M18 x 66	8.0	f	pnp, 200 mA, NC	10 to 35	-30 to +70	IP 67	VA	2 m, PVC	VK ...	KDC 18 M 08 NSLK
				nnp, 200 mA, NO							KDC 18 M 08 NOLK
	M18 x 75			pnp, 200 mA, NO							KDC 18 M 08 PSK-IBSL
				pnp, 200 mA, NC							KDC 18 M 08 POK-IBSL
nnp, 200 mA, NO		KDC 18 M 08 NSK-IBSL									
	nnp, 200 mA, NC	KDC 18 M 08 NOK-IBSL									
M18 x 76	8.0	f	pnp, 100 mA, NO	10 to 30	-25 to +85	IP 67		2 m, PUR		KDC 18 MB 08 PSL	
	M30 x 67	15	f	pnp, 100 mA, NO	10 to 30	-25 to +85	IP 67	VA	2 m, PUR	-	KDC 30 M 15 PSLK
	M30 x 67	20	f	pnp, 300 mA, NO/NC	10 to 35	-30 to +70	IP 67	VA	2 m, PUR		KDC 30 M 20 NSOLK
	M30 x 67	20	f	pnp, 300 mA, NO/NC	10 to 35	-30 to +70	IP 67	VA	M12	VK ...	KDC 30 M 20 PSOK-BSL
				nnp, 300 mA, NO/NC							KDC 30 M 20 NSOK-BSL
Capacitive proximity switch flat design											Product description
	Ø50 x 10	25 (adjustable)	f	pnp/nnp, 150 mA, NO/NC	10 to 30	-30 to +70	IP 67	Plastic	2 m, PUR		KDC 50 K 25 PNSOLK
	Ø50 x 10	25 (adjustable), self-compensating	nf	pnp, 300 mA, NO/NC	10 to 35	-10 to +60	IP 67	Plastic	2 m, PVC		KDC 50 K 25S PSOLK
	Ø50 x 10	25 (adjustable)	nf	nnp, 300 mA, NO/NC	10 to 35	-10 to +60	IP 67	Plastic	2 m, PVC		KDC 50 K 25S NSOLK
	Ø50 x 10	2.0 to 25	f	pnp/nnp, 150 mA, NO/NC	10 to 30	-30 to +70	IP 67	Plastic	M8	TK ...	KDC 50 K 25 PNSOK-TSL

Installation instructions for inductive and capacitive proximity switches

Flush installation (f)

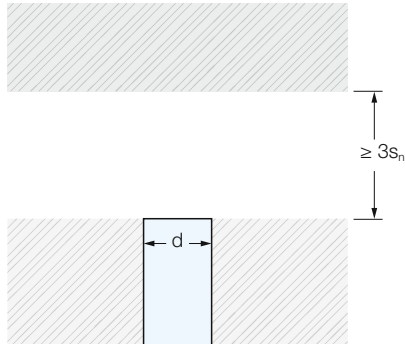

These proximity switches can be installed in all materials (metals / non-metals) such that the active sensor surface lines up flush with the surrounding material on the front side.

They have the following advantages:

- Flush installation in conductive materials (metals)
- Protection of the sensing surface prior to mechanical damage
- Less influence from external interference fields
- Less distance to the next proximity switch on the side

Non-flush installation (nf)

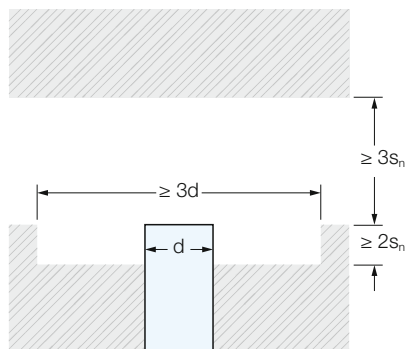

These proximity switches are allowed to be installed non-flush in conductive materials.

They have the greatest possible switching distance.

Special installation instructions apply to these proximity switches. Flush installation in nonconductive materials is permitted.

Quasi-flush installation (qf)

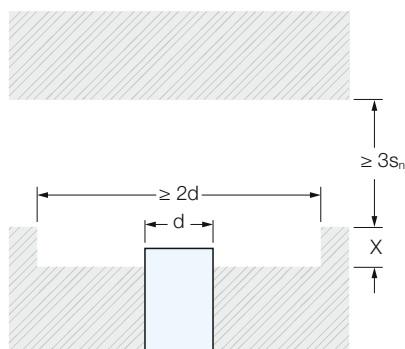

These proximity switches have a greater switching distance than proximity switches for flush installation. However, they are allowed to be installed in conductive materials only quasi-flush, i.e. not entirely flush. The proximity switches must protrude from the installation surface by dimension X (see the Installation instructions).

Flush installation in nonconductive materials is permitted.

Cylinder and gripper sensors

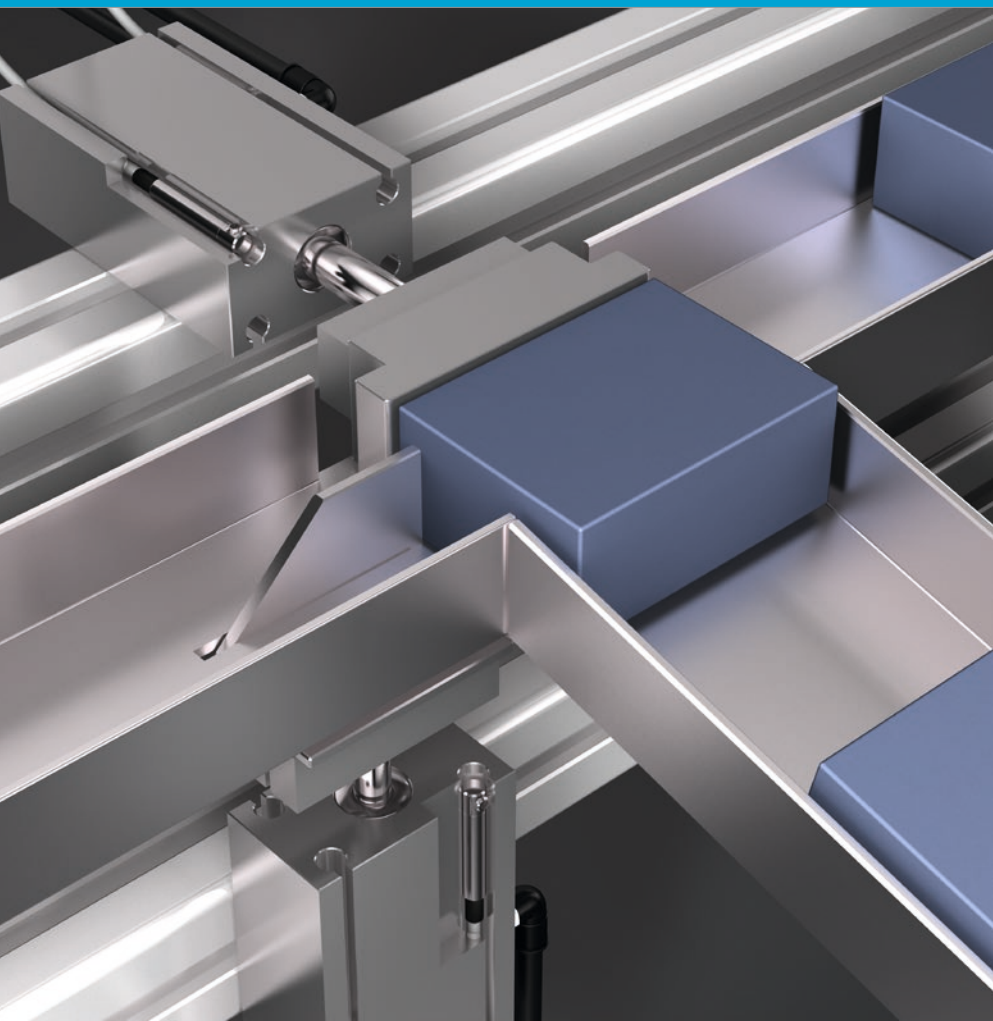

Cylinder sensors are designed for pneumatic cylinders with built-in magnets. The piston position is detected by the cylinder wall.



Cylinder sensors for the C-groove

- For all common pneumatic cylinders
- Versions that can be mounted from above
- High reproducibility
- Robust metal housing or impact-resistant plastic housing
- Mounting elements made of metal
- High protection type



Technical data (typ.)	+20 °C, 24 VDC
Service voltage	10 to 30 V DC
Voltage drop	2.0 V
	2.5 V (MZEEx 9-xx ...)
Switching frequency	1,000 Hz
Ambient temperature	-25 to +70 °C
	-25 to +80 °C (MZEC 9-xx ...)
Insulation voltage endurance	500 V
Polarity-safe	Yes
Protection type	IP 67

Housing design Size (mm)	Installation method	Housing material	Switching output	Short-circuit-proof	Reproducibility (mm)	Cable length (m)	Plug connector	Connection cable (optionally available)	Connection cable, PUJF	Product description
	←	V2A (1.4301 / AISI 304)	Transistor pnp 100 mA, NO	■	0.1	2.5	–	–		MZEC 3.7 VPS-3
						0.3	M8	TK ...		MZEC 3.7 VPS-K-T3
						0.6	M8	TK ...		MZEC 3.7 VPS-K0.6-T3
						0.3	M12	VK ...		MZEC 3.7 VPS-K-B3
	←	V2A (1.4301 / AISI 304)	Transistor npn 100 mA, NO	■	0.1	2.5	–	–		MZEC 3.7 VNS-3
						0.3	M8	TK ...		MZEC 3.7 VNS-K-T3
						0.6	M8	TK ...		MZEC 3.7 VNS-K0.6-T3
						0.3	M12	VK ...		MZEC 3.7 VNS-K-B3
	←	V2A (1.4301 / AISI 304)	Transistor pnp 100 mA, NO	■	0.1	2.5	–	–		MZEC 4.0 PSL
						0.3	M8	TK ...		MZEC 4.0 PS-K-TSSL
						0.6	M8	TK ...		MZEC 4.0 PS-K0.6-TSSL
						0.3	M12	VK ...		MZEC 4.0 PS-K-IBS
	↓	Polyamide, mounting eccentric stainless steel	Transistor pnp 100 mA, NO	■	0.2	2.0	–	–		MZEC 9-18 PSL
						0.3	M8	TK ...	■	MZEC 9-18 PSL-K-TSS
						0.3	M12	VK ...		MZEC 9-18 PSL-K-IBS
	↓	Polyamide, mounting eccentric stainless steel	Transistor pnp 100 mA, NO	■	0.2	2.0	–	–		MZEC 9-26 PSL
						0.3	M8	TK ...	■	MZEC 9-26 PSL-K-TSS

- ← Mounting lengthwise along the groove
- ↓ Can be inserted into the groove from above

¹⁾ With an Allen screw

Cylinder sensors

Cylinder sensors for the T-groove

- For all common pneumatic cylinders
- Versions that can be mounted from above
- High reproducibility
- Robust metal housing or impact-resistant plastic housing
- Mounting elements made of metal
- High protection type

Technical data (typ.)	+20 °C, 24 VDC
Service voltage	10 to 30 V DC
Switching output	Transistor pnp / NO
Voltage drop	2.0 V
Switching frequency	1,000 Hz
Ambient temperature	-25 to +70 °C
Insulation voltage endurance	500 V
Polarity-safe	Yes
Protection type	IP 67



	Housing design Size (mm)	Installation method	Housing material	Current-carrying capacity (mA)	Short-circuit-proof	Reproducibility (mm)	Cable length (m)	Plug connector	Suitable connection cable (optionally available)	Connector cable: PUR, welding-spark-resistant	Product description
	6.1 x 5 x 25		Die-cast zinc	200	■	0.1	2.5	–	–	■	MZET 25 PSLK
							0.3	M8	TK ...		MZET 25 PSK-K-TSSL
							0.6	M8	TK ...		MZET 25 PSK-K0.6-TSSL
							0.3	M12	VK ...		MZET 25 PSK-K-IBS
	6.1 x 5 x 25		Die-cast zinc	200	■	0.1	2.5	–	–	■	MZET 28 PSLK
							0.3	M8	TK ...		MZET 28 PSK-K-TSSL
							0.6	M8	TK ...		MZET 28 PSK-K0.6-TSSL
							0.3	M12	VK ...		MZET 28 PSK-K-IBS
	5 x 7 x 20		Die-cast zinc	200	■	0.1	–	M8	TK ...		MZERT 20 PSK-TSSL
											MZERTI 20 PSK-TSSL ¹⁾
	5 x 6.5 x 25		Polyamide, mounting eccentric stainless steel	100	■	0.2	2.0	–	–	■	MZET 9-25
							0.3	M8	TK ...		MZET 9-25 PSL-K-TSS
							0.3	M12	VK ...		MZET 9-25 PSL-K-IBS

Mounting lengthwise along the groove
 Can be inserted into the groove from above

¹⁾ With an Allen screw

Gripper system sensors

- Specially aligned magnetic field for use on gripping tongs
- High reproducibility
- Flexible connection cable
- Short design
- Mounting element made of stainless steel
- High protection type

Technical data (typ.)	+20 °C, 24 VDC
Service voltage	10 to 30 V DC
Switching output	Transistor pnp / NO
Voltage drop	2.0 V
Switching frequency	1,000 Hz
Ambient temperature	-25 to +70 °C
Insulation voltage endurance	500 V
Polarity-safe	Yes
Protection type	IP 67



	Housing design Size (mm)	Installation method	Housing material	Current-carrying capacity (mA)	Short-circuit-proof	Reproducibility (mm)	Cable length (m)	Plug connector	Connection cable (optionally available)	Connection cable, PUR	
	Sensors for gripper systems for the C-groove										Product description
	Ø3.9x21		Stainless steel, plastic	100		0.1	2.5	-	-		MZES 3.9 PSL
							5.0	-	-		MZES 3.9 PSL/5
							0.3	M8	TK ...		MZES 3.9 PS-K-TSSL
							0.6	M8	TK ...		MZES 3.9 PS-K0.6-TSSL
	Sensors for gripper systems for the T-groove										
	6.1 x 5 x 25		Die-cast zinc	100		0.1	2.5	-	-	■	MZES 25 PSL
							0.3	M8	TK ...		MZES 25 PS-K-TSSL

Mounting lengthwise along the groove
 Can be inserted into the groove from above

¹⁾ With an Allen screw

Ultrasonic sensors

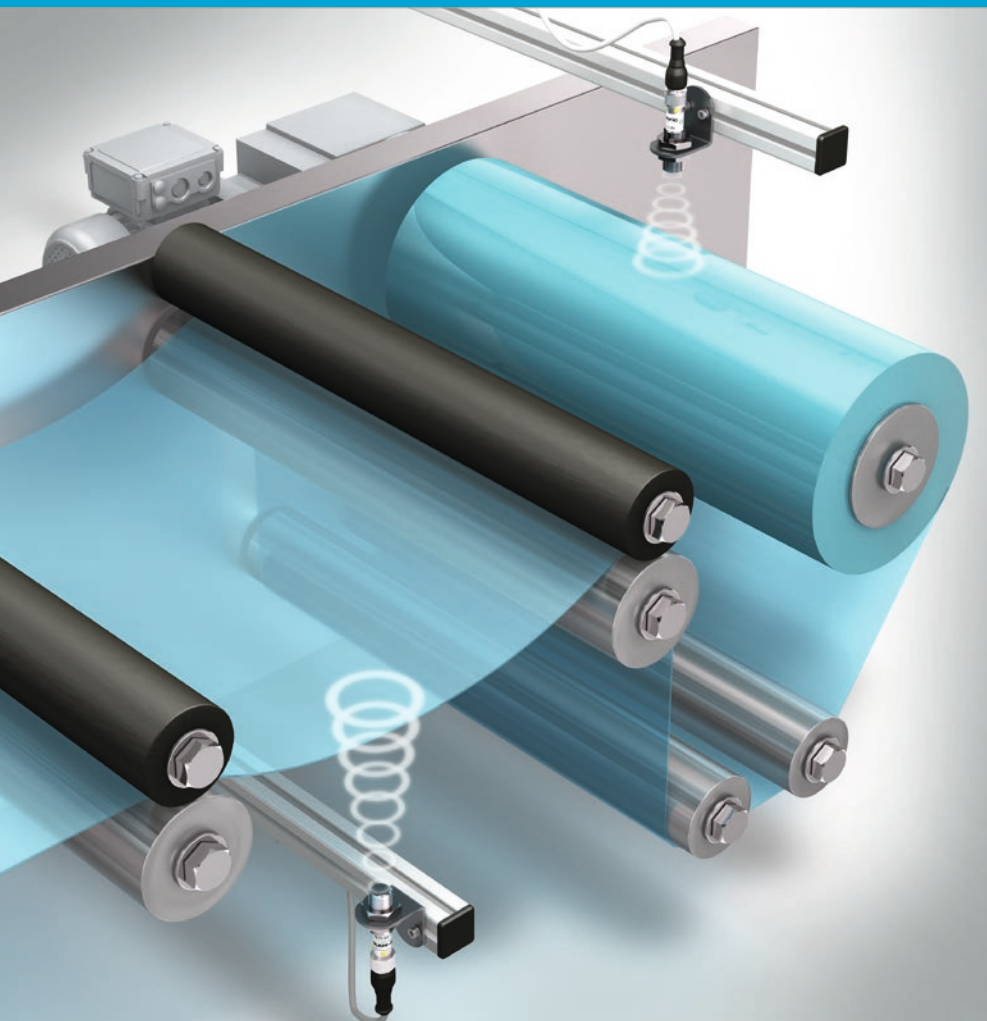

Ultrasonic sensors are used for distance measurement for automation tasks. These sensors measure the transit time of the sound, which enables them to reliably detect even transparent, liquid and powdered objects.

Ultrasonic sensors

- Insensitive to dirt
- Insensitive to ambient noise
- High resolution
- High follow-up speed
- Measurement regardless of surface
- Operating range can be set up to 6 m
- Synchronization input/
release input
- Release input



NEW

Ultrasonic sensors
with IO-Link, analog output
and Multi I/O

 **IO-Link**

CE

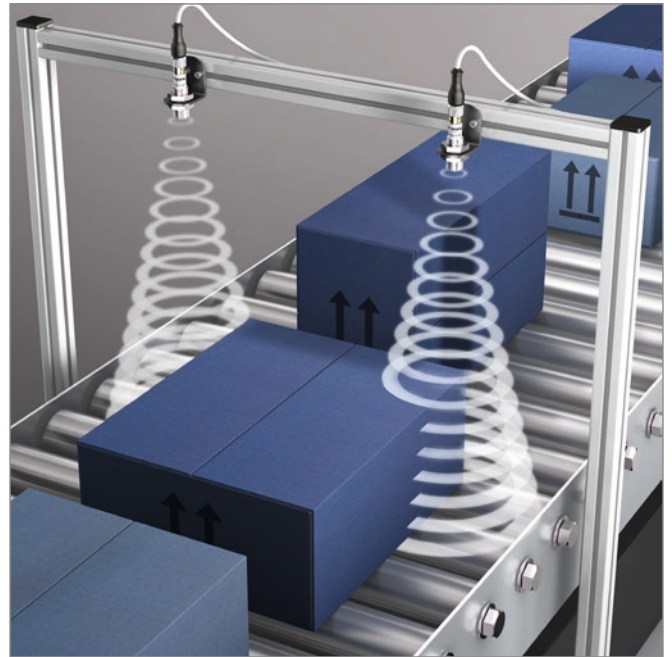
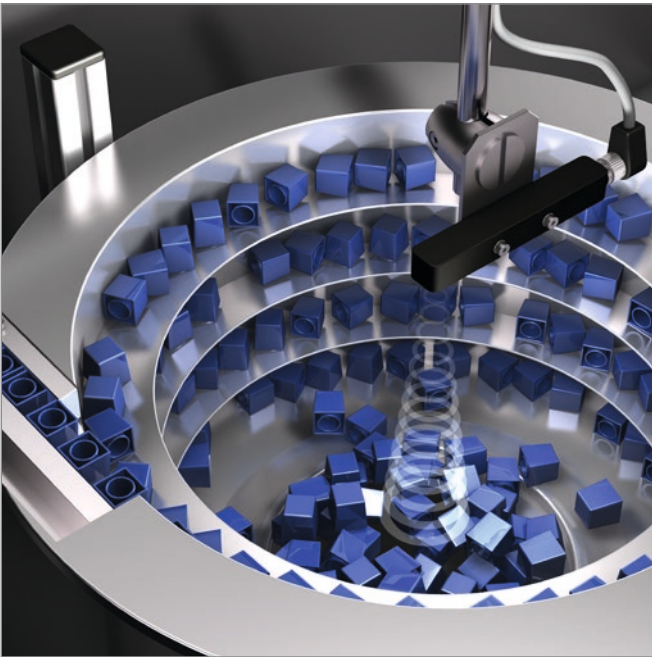

Ultrasonic sensors

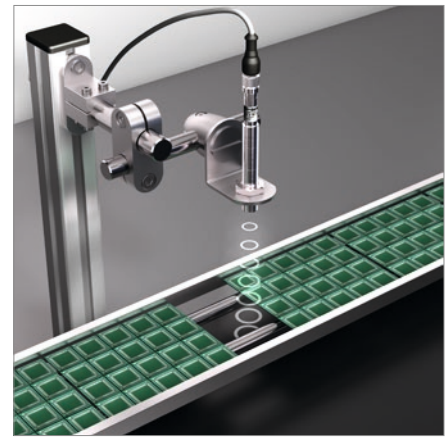

Ultrasonic sensors with IO-Link

- Greatly simplified teach process
- Can be configured with IO-Link as a sensor or retroreflective sensor
- Additional switching output thanks to MI/O
- Variants with switching output and analog output

IO-LINK IN A NUTSHELL.

IO-Link provides a point-to-point connection within any network, fieldbus or backplane bus. The IO-Link master can be installed either directly in the field or in the control cabinet.

Any sensor, actuator or even a combination of the two can be an IO-Link device. This device is connected to the IO-Link master by a standard connection cable up to 20 m long. The IO-Link device communicates with the IO-Link master using a driver file (the IO-DD – IO-Link Device Description) and can send and receive signals (binary switch signals or analog signals). IO-Link digitizes these signals directly so that they can be transferred virtually free of interference.

The international IO-Link standard (in accordance with IEC 61131-9) is now regarded as an "enabler for Industry 4.0"

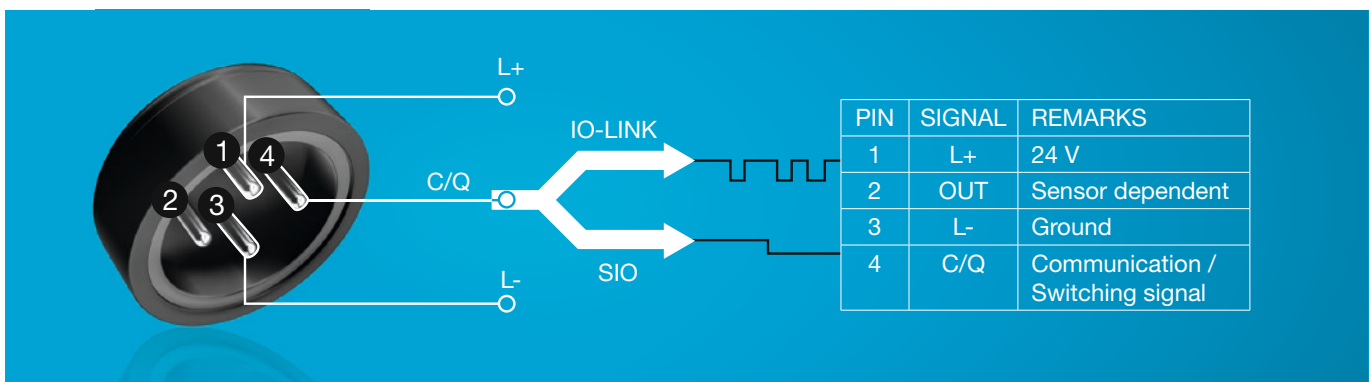







Ultrasonic distance sensors with IO-Link / MI/O







This new generation of ultrasonic sensors has IO-Link with considerably improved performance data.

These ultrasonic sensors can be ideally adapted to the application by configuring IO-Link and can monitor the process stability by means of IO-Link diagnostics.

Technical data (typ.)	+20°C, 24 VDC
Service voltage	18 to 30 V DC
Protection type	IP 67
Housing material	Brass, nickel-plated











	Operating range (mm)	Housing design Size (mm)	Sound outlet	Switching output	Analog output	Repeatability	Ambient temperature (°C)	Plug connector	Connection cable (optionally available)	Product description
Ultrasonic distance sensors with IO-Link (switching output)										
	20 to 100	M8 x 70	Axial	Push-pull, 150 mA NO/NC	–	0.3 mm	0 to 50	M8	TK ... /4	US 08 M 100 G3-B4
	20 to 200	M12 x 65	Axial	Push-pull, 150 mA NO/NC	–	0.5 mm	-25 to 70	M12	VK ... /4	US 12 M 200 G3-B4
	40 to 400	M12 x 65	Axial	Push-pull, 150 mA NO/NC	–	0.5 mm	-10 to 70	M12	VK ... /4	US 12 M 400 G3-B4
	80 to 800	M18 x 55.5	Axial	Push-pull, 150 mA NO/NC	–	±0.15 %	-25 to 70	M12	VK ... /4	US 18 M 800 G3-B4
	120 to 1,500	M18 x 55.5	Axial	Push-pull, 150 mA NO/NC	–	±0.15 %	-25 to 70	M12	VK ... /4	US 18 M 1500 G3-B4
	300 to 3,000	M30 x 60	Axial	Push-pull, 100 mA NO/NC	–	2.0 mm	-25 to 70	M12	VK ... /4	US 30 M 3000 G3-B4
	600 to 6,000	M30 x 78	Axial	Push-pull, 100 mA NO/NC	–	4.0 mm	-25 to 70	M12	VK ... /4	US 30 M 6000 G3-B4



	Operating range (mm)	Housing design Size (mm)	Sound outlet	Switching output	Analog output	Repeatability	Ambient temperature (°C)	Plug connector	Connection cable (optionally available)	Product description
Ultrasonic distance sensors with IO-Link, analog output and MI/O										
	20 to 200	M12 x 75	Axial	–	0 to 10 V 4.0 to 20 mA	–	-25 to 70	M12	VK ... /4	US 12 M 200 IU-B4
	40 to 400	M12 x 75	Axial	Push-pull, 150 mA NO/NC	0 to 10 V 4 to 20 mA	–	-10 to 70	M12	VK ... /4	US 12 M 400 IU-B4
	80 to 800	M18 x 65	Axial	Push-pull, 150 mA	0 to 10 V 4 to 20 mA	–	-25 to 70	M12	VK ... /4	US 18 M 800 IU-B4
	150 to 1,500	M18 x 65	Axial	Push-pull, 150 mA NO/NC	0 to 10 V 4 to 20 mA	–	-25 to 70	M12	VK ... /4	US 18 M 1500 IU-B4
	300 to 3,000	M30 x 60	Axial	Push-pull, 100 mA NO/NC	0 to 10 V 4 to 20 mA	–	-25 to 70	M12	VK ... /4	US 30 M 3000 IU-B4
	600 to 6,000	M30 x 78	Axial	Push-pull, 100 mA NO/NC	0 to 10 V 4 to 20 mA	–	-25 to 70	M12	VK ... /4	US 30 M 6000 IU-B4

Ultrasonic sensors





Technical data (typ.)	+20 °C, 24 VDC
Service voltage	18 to 30 V DC Some variants have an expanded service voltage range from 12 to 36 VDC
Protection type	IP 67

	Operating range (mm) fork width / measuring range (mm)	Housing design Size (mm)	Sound outlet	Switching output	Analog output	Repeatability	Ambient temperature (°C)	Housing material	Plug connector	Connection cable (optionally available)	Product description
	20 to 150	M12 x 72	Axial	pnp, 100 mA NO/NC	–	0.5%	0 to 70	Brass nickel plated	M12	VK.../4	USTI 12 TFB 150 PSOK-IBSL
				–	0 to 10 V						USTI 12 TFB 150 A-IBSL
				–	4.0 to 20 mA						USTI 12 TFB 150 I-IBSL
	120 to 1,500	Ø54 x 106	Axial	pnp, 100 mA NO/NC	–	2% / Sn max.	0 to 60	Brass nickel plated PVDF	M12	VK.../4	UST 17 T 1500 P3-B4
				npn, 100 mA NO/NC	–						UST 17 T 1500 N3-B4
				–	0 to 10 V 4 to 20 mA						UST 17 T 1500 IU-B4
	30 to 200	M18 x 81.5	Radial	pnp, 150 mA NO	–	–	-25 to 70	Brass nickel plated	M12	VK.../4	USCTI 18 MR 200 FPSK-BSL
	0 to 200										USCRTI 18 MR 200 FPSK-BSL
	120 to 1,500	M18 x 123	Radial	pnp, 100 mA NO/NC	–	2% / Sn max.	0 to 60	Brass nickel plated	M12	VK.../4	UST 18 MR 1500 P3-B4
				npn, 100 mA NO/NC	–						UST 18 MR 1500 N3-B4
				–	0 to 10 V 4 to 20 mA						UST 18 MR 1500 IU-B4
	0 to 200	M30 x 71	Axial	pnp, 100 mA NO	–	–	-20 to 50	Brass nickel plated	M12	VK...	US 30 M 200 PSK-IBS
	40 to 400	12 x 12 x 75	Radial	Push-pull, 150 mA, NO/NC	–	< 0.5 mm	0 to 50	Aluminum, anodized	M8	TK.../4	UST Q12 M 400 G3-T4
	60 to 150	46 x 30 x 18	Radial	pnp, 100 mA NO	–	1% / Sn max.	0 to 50	Polyamide V2A	M8	TK...	US 46 K 150 PSK-TSSL
				npn, 100 mA NO						TK...	US 46 K 150 NSK-TSSL
	120 to 500	46 x 30 x 18	Radial	pnp, 100 mA NO	–	1% / Sn max.	0 to 50	Polyamide V2A	M8	TK...	US 46 K 500 PSK-TSSL

Ultrasonic sensors

	Operating range (mm) fork width / measuring range (mm)	Housing design Size (mm)	Sound outlet	Switching output	Analog output	Repeatability	Ambient temperature (°C)	Housing material	Plug connector	Connection cable (optionally available)		
Ultrasonic distance sensors											Product description	
	80 to 500	60 x 41 x 32	Radial	pnp, 100 mA 2xNO	–	1% / Sn max.	0 to 50	Polyamide	M8	TK ... /4	US 60 K 500 PSS-TSSL	
				pnp, 100 mA NO + NC	–						US 60 K 500 PSO-TSSL	
				pnp, 100 mA NO	0 to 10 V						US 60 K 500 PSA-TSSL	
				pnp, 100 mA NO	10 to 0 V						US 60 K 500 PSA-I-TSSL	
				pnp, 100 mA NO	4 to 20 mA						US 60 K 500 PSI-TSSL	
				pnp, 100 mA NO	20 to 4 mA						US 60 K 500 PSI-I-TSSL	
	80 to 800	60 x 41 x 32	Radial	–	0 to 10 V 4 to 20 mA	1% / Sn max.	0 to 50	Polyamide	M8	TK ... /4	US 60 K 500 AI-TSSL	
				–	10 to 0 V 20 to 4 mA						US 60 K 500 AI-I-TSSL	
		135 to 1,000	60 x 41 x 32	Radial	pnp, 100 mA 2xNO	–	1% / Sn max.	0 to 50	Polyamide	M8	TK ... /4	US 60 K 1000 PSS-TSSL
					pnp, 100 mA NO + NC	–						US 60 K 1000 PSO-TSSL
					pnp, 100 mA NO	0 to 10 V						US 60 K 1000 PSA-TSSL
					pnp, 100 mA NO	10 to 0 V						US 60 K 1000 PSA-I-TSSL
pnp, 100 mA NO					4 to 20 mA	US 60 K 1000 PSI-TSSL						
pnp, 100 mA NO					20 to 4 mA	US 60 K 1000 PSI-I-TSSL						
135 to 1,500		60 x 41 x 32	Radial	–	0 to 10 V 4 to 20 mA 10 to 0 V 20 to 4 mA	1% / Sn max.	0 to 50	Polyamide	M8	TK ... /4	US 60 K 1000 AI-TSSL	
				–	US 60 K 1000 AI-I-TSSL							

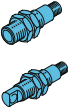
Ultrasonic sensors

	Operating range (mm) fork width / measuring range (mm)	Housing design Size (mm)	Sound outlet	Switching output	Analog output	Repeatability	Ambient temperature (°C)	Housing material	Plug connector	Connection cable (optionally available)	
Ultrasonic distance sensors											Product description
	250 to 2,500	60 x 41 x 33	Radial	pnp, 100 mA 2 x NO	–	1% / Sn max.	0 to 50	Polyamide	M8	TK ... /4	US 60 K 2500 PSS-TSSL
				pnp, 100 mA NO + NC	–						US 60 K 2500 PSO-TSSL
				pnp, 100 mA NO	0 to 10 V						US 60 K 2500 PSA-TSSL
				pnp, 100 mA NO	10 to 0 V						US 60 K 2500 PSA-I-TSSL
				pnp, 100 mA NO	4 to 20 mA						US 60 K 2500 PSI-TSSL
				pnp, 100 mA NO	20 to 4 mA						US 60 K 2500 PSI-I-TSSL
250 to 3,000	60 x 41 x 33	Radial	–	0 to 10 V	1% / Sn max.	0 to 50	Polyamide	M8	TK ... /4	US 60 K 2500 AI-TSSL	
				4 to 20 mA						10 to 0 V	US 60 K 2500 AI-I-TSSL
	400 to 5,000	60 x 41 x 38	Radial	pnp, 100 mA 2 x NO	–	1% / Sn max.	0 to 50	Polyamide	M8	TK ... /4	US 60 K 5000 PSS-TSSL
				pnp, 100 mA NO + NC	–						US 60 K 5000 PSO-TSSL
				pnp, 100 mA NO	0 to 10 V						US 60 K 5000 PSA-TSSL
				pnp, 100 mA NO	10 to 0 V						US 60 K 5000 PSA-I-TSSL
				pnp, 100 mA NO	4 to 20 mA						US 60 K 5000 PSI-TSSL
				pnp, 100 mA NO	20 to 4 mA						US 60 K 5000 PSI-I-TSSL
400 to 6,000	60 x 41 x 38	Radial	–	0 to 10 V	1% / Sn max.	0 to 50	Polyamide	M8	TK ... /4	US 60 K 5000 AI-TSSL	
				4 to 20 mA						10 to 0 V	US 60 K 5000 AI-I-TSSL
Ultrasonic retroreflective sensors											
	0 to 200	M18 x 63.5	Axial	pnp, 150 mA NO	–	–	-25 to 70	Brass nickel plated	M12	VK ... /4	USCRTI 18 M 200 FPSK-BSL
	0 to 700	M18 x 81.5	Radial								USCRTI 18 MR 700 FPSK-BSL
Ultrasonic through-beam sensors											
	0 to 1,500	Receiver	Radial	pnp, 100 mA NO	–	–	0 to 50	Polyamide V2A	M8	TK ...	USE 46 K 1500 PSKT-TSSL
				npn, 100 mA NO							USE 46 K 1500 NSKT-TSSL
			Transmitter	Radial	–	–	–	0 to 50	Polyamide V2A	M8	TK ...

Ultrasonic fork light barrier

Ultrasonic fork light barriers have been specially designed for web edge control, even of transparent materials. The control range can be taught in through teach-in and the web edge fluctuations are forwarded using a standard signal to the downstream web edge control.

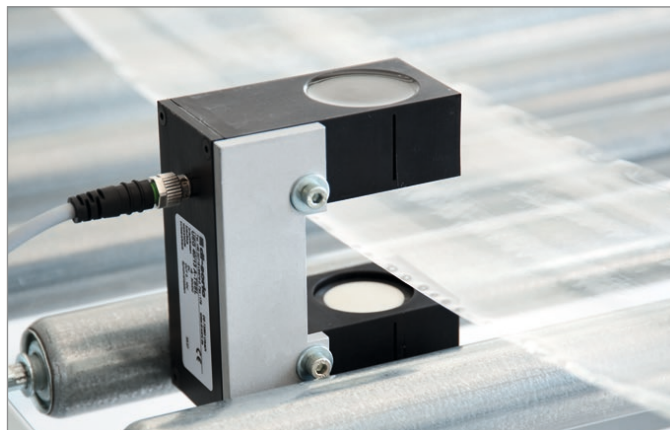

- Large linearized analog range
- Very high repeatability
- Web edge control also with transparent materials
- Insensitive to dirt
- Robust metal housing



	Operating range (mm) fork width / measuring range (mm)	Housing design Size (mm)	Switching output	Analog output	Repeatability	Ambient temperature (°C)	Housing material	Plug connector	Connection cable (optionally available)	
Ultrasonic fork light barriers										Product description
	30/8	74 x 30 x 65	–							USGT 30/8 U-B4
	40/13	92 x 39 x 80	–	0 to 10 V 10 to 0 V	0.15 mm ¹⁾	0 to 60	Aluminum anodized	M12	VK.../4	USGT 40/13 U-B4
	60/8	104 x 30 x 65	–							USGT 60/8 U-B4
	70/13	122 x 39 x 80	–							USGT 70/13 U-B4

¹⁾For 50% cover

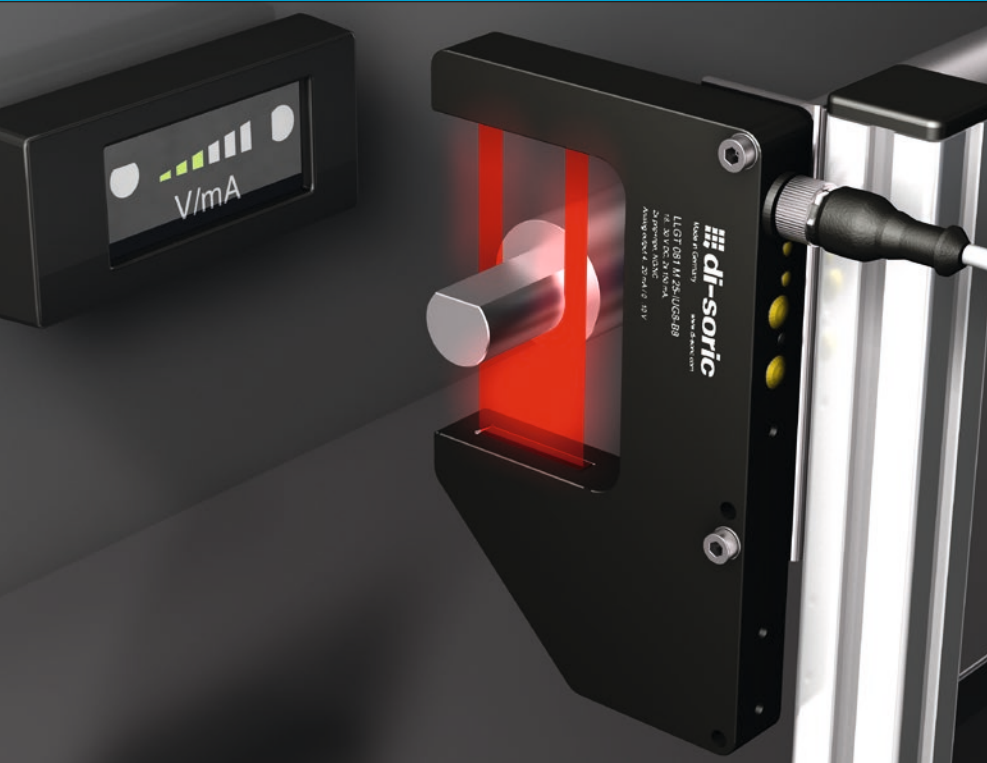

Line laser fork light barriers

- Teach-in for measuring area and switching outputs
- Remote teach option with key-lock function
- Current/voltage output switchable
- Switching outputs with window mode



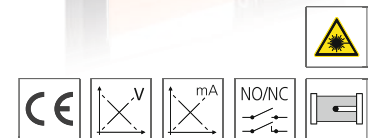

The measuring, high-resolution laser line laser fork light barrier is used to reliably capture and analyze even the smallest differences in dimensions.



Technical data (typ.)	at +20 °C, 24 VDC		
Fork width	80 mm	Frequency of measuring sequence	200 Hz
Emitted light	Red-light laser line, 650 nm, clocked	Characteristics	Trigger input
Laser class	1 (EN60825-1)	Display	LED green (operation)
Service voltage	18 to 30 V DC		LED yellow (switching outputs)
No-load current	70 mA (24 V DC)	Voltage drop	2 V
Resolution	> 20 µm (analog output)	Ambient temperature	+5 to 45 °C
Smallest detectable object	Ø 0.5 mm (switching output)	Ambient light immunity	5 kLx
Measuring range	25 mm	Insulation voltage endurance	500 V
Switching output	Push-pull, 150 mA (2x)	Protection type	IP 67
Switching hysteresis	0.1 mm	Protection class	III, operation on protective low voltage
Analog output	4 to 20 mA / 0 to 10 V switchable	Housing material	Aluminum, black anodized
Analog output linearity	± 0.3%	Protection optics	PMMA
Admissible impedance	≤ 500 ohm / ≥ 1 kohm	Plug connector	M12 connector, 8-pin

Line laser fork light barrier	Product description		
	Fork width	80 mm	LLGT 081 M 25 IUG8-B8

Accessories					
M12 connection cable, 8-pin, angled, flying leads					
	Protection type	IP 67	Cable length	2.5 m	VKHM-W-2.5/8
			5 m	VKHM-W-5/8	

M12 connection cable, 8-pin, straight, flying leads					
	Protection type	IP 67	Cable length	2.5 m	VKHM-Z-2.5/8
			5 m	VKHM-Z-5/8	

Optical movement sensors

Optical movement sensor OBS 60 ...

A compact movement sensor for detecting rotational and feed movements in a wide variety of materials. Movements are indicated using a switching output.

Optical movement sensor OBSR 60 ...

This movement sensor can also detect the direction of movement in a movement axis. It can be toggled between two axes. The directions of movement are output over two switching outputs.

- For non-contact feed control, also suitable for use at reduced speed and with wires
- Detection of metallic, non-metallic, and shiny surfaces
- Adjustable pulse stretching



OBS:

Detection of motion or zero speed

OBSR:

- Detection of direction with 2 switching outputs



Technical data (typ.)		+20 °C, 24 VDC	
Service voltage	10 to 30V DC	Ambient light immunity	5 kLx
No-load current	30 mA	Ambient temperature	+5 to +45 °C
Diameter of light spot	Ø 2.0 mm	Insulation voltage endurance	500 V
Working distance	30 ± 10 based on material	Protection type	IP 67
Pulse stretching	1 to 1,000 ms, adjustable	Protection class	III, operation on protective low voltage
Activation time	10 ms	Housing material	Aluminum, black anodized
Emitted light	Infrared laser, 850 nm	Window material	PMMA
Laser class (EN 60825-1)	1M		

Movement sensor	Detection of direction	Speed (m/s, based on material)	Push-pull, 150 mA	NO/NC, switchable	NO	Voltage drop (V)	LED: Switching output	LED: Switching output (yellow), operation (green)	Plug connector	Connection cable (optionally available)	
Motion detection											Product description
	■	<5.0	1x	■		2.5		■	M8, 3-pin	TK ...	OBS 60 M 30 G3-T3
Detection of direction											
	■	X or Y	<5.0	2x		2.0	2x		M8, 4-pin	TK ... /4	OBSR 60 M 30 G8-T4

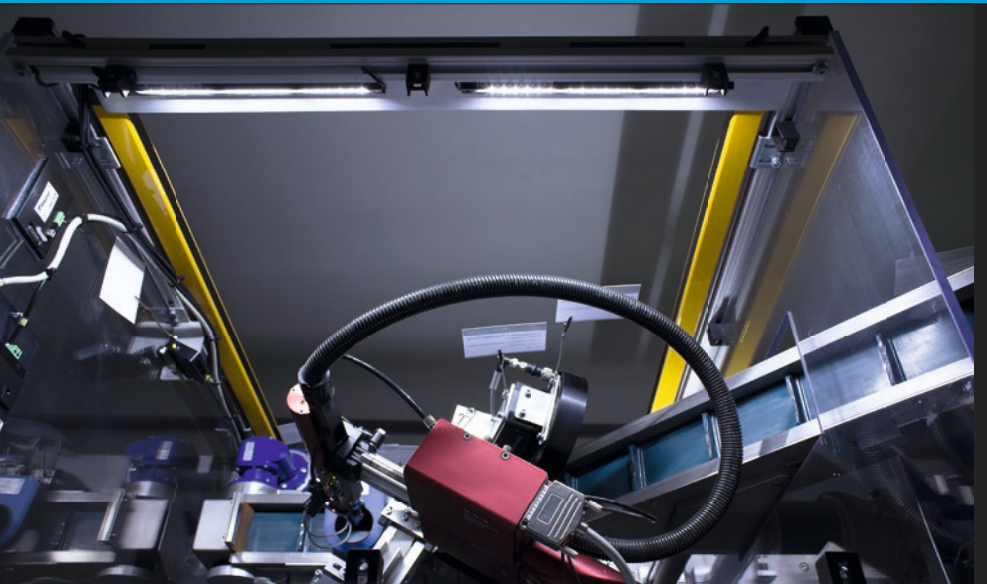

The extremely powerful and quick-to-integrate MB-N LED machine lighting allows ongoing processes in machines to be observed with accuracy as well as rapid retooling and maintenance—guaranteeing maximum efficiency.

Efficient, extreme light intensity and easy installation

- Comprehensive range of lengths: 250 / 480 / 700 / 910 mm often means that the lighting does not have to be cascaded
- Compact design with width of just 40 mm allows lighting to be used anywhere
- Mounted using magnetic holder set rather than time-consuming drilling and screwing
- Swivel-mounted retaining bracket for dazzle-free installation

Maximum safety at the workplace in accordance with DIN EN 12464-1

- Very high color rendering ensures safety at the workplace in accordance with DIN EN 12464-1 (color rendering index R_a 85, 5000K color temperature)
- New high-performance LEDs with very high light intensity ensure reliable and even illumination
- Energy-saving system light yield of >100 lumens per watt
- Very homogeneous wide-angle illumination of 120°

Very long life thanks to tested quality

- Extremely long life thanks to intelligent thermal management and trigger input
- Outstanding energy efficiency
- Maximum robustness thanks to shock-resistant and vibration-resistant housing with protection class IP 67
- Made-in-Germany quality

NEW:

In black or natural aluminum

- Integrates into machines seamlessly

MB-NPprotected

- Also ideal for tough application conditions with its stainless steel front frame and safety glass



NEW





Machine lighting

This durable and reliable machine lighting is designed especially for industrial use for general mechanical engineering.

Highly efficient power LEDs and industrial encapsulation guarantee outstanding performance data. The lighting features an input through which it can be switched off and dimmed.

Technical data (typ.)	+20 °C
Service voltage	24 VDC (Supply Class 2)
Light color	5,000 K white (LED)
Ambient temperature	0 to 40 °C (MB-100 / MB-NP ...)
	0 to 40 °C (MB-N ...)
Protection type	IP 67
Connection cable	VK... (optionally available)

	Illuminated area (mm)	No-load current at 24 V	Power draw at 24 V	Light intensity at 0.5 m	Light intensity at 1.0 m	Luminous flux	Housing material				Weight (excluding packaging)	Product description
	77 x 25		3.1 W	350lx	100lx		■		■		50g	MB-100-K-B3
											70g	MB-100-K

MB-N												
	95 x 30	190mA	4.6 W	720lx	220lx	440lm	■		■		115g	MB-N-125-K-B3
											175g	MB-N-125-K
	220 x 30	450mA	10.8 W	1800lx	530lx	1100lm	■		■		210g	MB-N-250-K-B3
											260g	MB-N-250-K
	440 x 30	900mA	21.6 W	3200lx	1000lx	2200lm	■		■		390g	MB-N-480-K-B3
											440g	MB-N-480-K
	660 x 30	1350mA	32.4 W	3900lx	1300lx	3300lm	■		■		550g	MB-N-700-K-B3
											600g	MB-N-700-K
	870 x 30	1800mA	43.2 W	4400lx	1600lx	4400lm	■		■		700g	MB-N-910-K-B3
											750g	MB-N-910-K

	95 x 30	190mA	4.6 W	720lx	220lx	440lm	■		■		115g	MB-N-126-K-B3
											175g	MB-N-126-K
	220 x 30	450mA	10.8 W	1800lx	530lx	1100lm	■		■		210g	MB-N-251-K-B3
											260g	MB-N-251-K
	440 x 30	900mA	21.6 W	3200lx	1000lx	2200lm	■		■		390g	MB-N-481-K-B3
											440g	MB-N-481-K
	660 x 30	1350mA	32.4 W	3900lx	1300lx	3300lm	■		■		550g	MB-N-701-K-B3
											600g	MB-N-701-K
	870 x 30	1800mA	43.2 W	4400lx	1600lx	4400lm	■		■		700g	MB-N-911-K-B3
											750g	MB-N-911-K

MB-NP Protected, for use in corrosive environments												
	30 x 220	450mA	10.8 W	1,400lx	430lx		■			■	410g	MB-NP-250-K
	30 x 440	900mA	21.6 W	2,600lx	800lx		■			■	700g	MB-NP-480-K

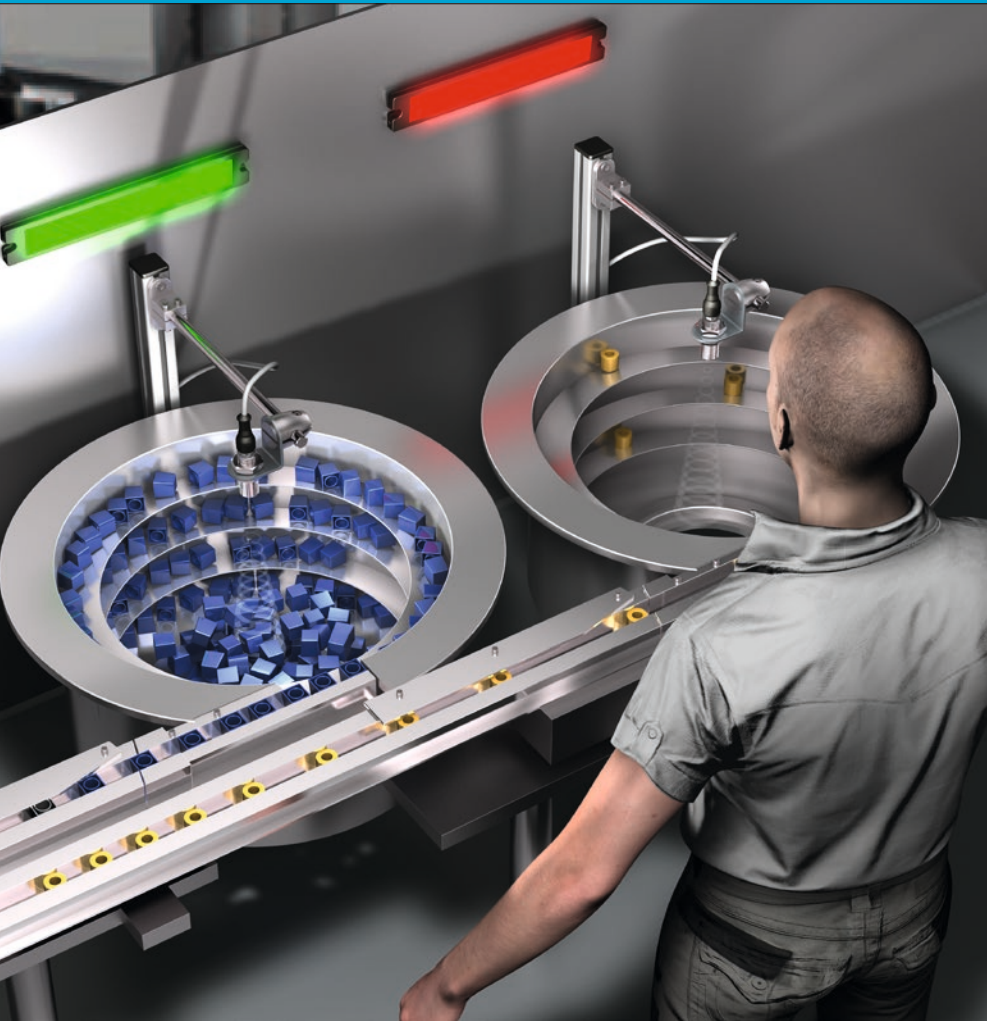

Machine lighting with signal lighting element MB-RGBW...

- High light intensity thanks to state-of-the-art Power LEDs
- Easy operation is also possible without IO-Link
- High color rendering guarantees workplace safety in accordance with DIN EN 12464-1 / EN 12464-1
- Large illuminated area for optimal display of machine status
- Freely configurable functions via IO-Link
- Long life thanks to intelligent thermal management
- Homogeneous wide light field for optimal machine lighting
- Can be used immediately thanks to three color pre-sets: red - green - yellow

SB-RGB signal lighting ...

- High light intensity thanks to state-of-the-art high-efficiency LEDs
- Easy operation is also possible without IO-Link
- Freely configurable functions via IO-Link
- Long life thanks to intelligent thermal management
- Large illuminated area for optimal display of machine status
- Can be used immediately thanks to three color pre-sets: red - green - yellow

NEW:

In black or natural aluminum

- Integrates into machines seamlessly

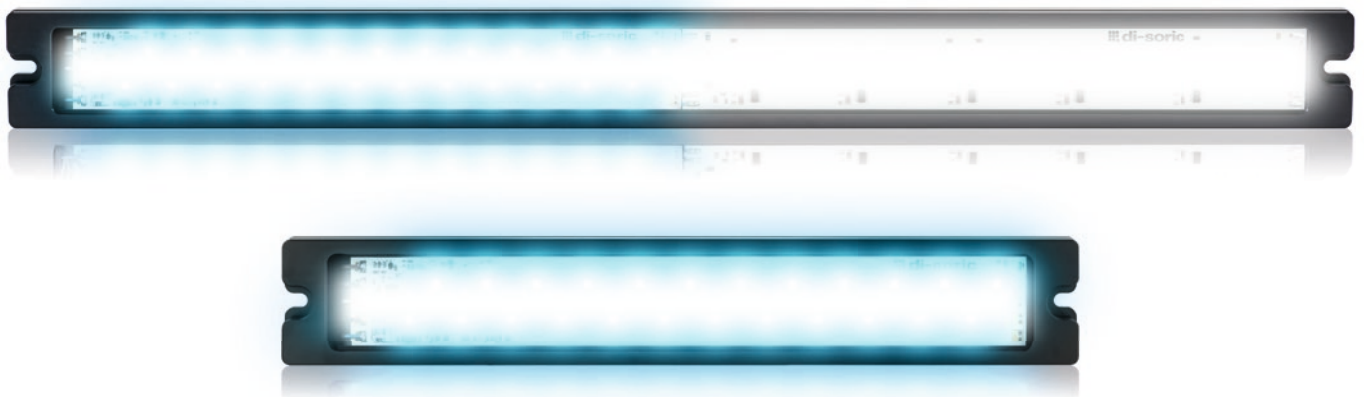

Machine lighting with signal lighting element MB-RG-BW

The MB-RGBW elements offer the high-quality white light with top-quality color reproduction provided by our machine lighting, combined with the machine status display using a powerful RGB signal light element.

SB-RGB signal lighting

The newly available SB-RGB signal lights are intelligent units that can be adapted to custom requirements. They feature a large RGB illuminated area and display the machine status so that it is visible from far away.

Technical data (typ.)	+20 °C
Service voltage	24 VDC (Supply Class 2)
Light color	RGB + user-defined
Ambient temperature	0 to 40 °C
Protection type	IP 67
Operation modes	RGB: constant, blinking, flashing (MB-RGBW...) Flashing (SB-RGB...)
Plug connector	Cable: 300 mm with M12 connector, 5-pin
Connection cable	VK .../5 (optionally available)

NEW

IO-Link

	Illuminated area (mm)	No-load current at 24 V DC	Power draw at 24 V	Luminous flux	Aluminum, black anodized	Aluminum, natural anodized	PU crystal clear (window)	Weight (excluding packaging)	
Machine lighting with signal lighting element and IO-Link									
	440 x 30	650 mA	15.6 W	1,100 lm				390 g	MB-RGBW-480-K-B5
	660 x 30	1,100 mA	26.4 W	2,200 lm	■		■	550 g	MB-RGBW-700-K-B5
	870 x 30	1,520 mA	36.5 W	3,300 lm				700 g	MB-RGBW-910-K-B5
	440 x 30	650 mA	15.6 W	1,100 lm				390 g	MB-RGBW-481-K-B5
	660 x 30	1,100 mA	26.4 W	2,200 lm		■	■	550 g	MB-RGBW-701-K-B5
	870 x 30	1,520 mA	36.5 W	3,300 lm				700 g	MB-RGBW-911-K-B5
Signal lighting with IO-Link									
	220 x 30	195 mA RMS / 390 mA Peak	4.7 W					210 g	SB-RGB-250-K-B5
	440 x 30	385 mA RMS / 750 mA Peak	9.2 W					390 g	SB-RGB-480-K-B5
	660 x 30	565 mA RMS / 1,100 mA Peak	13.5 W		■		■	550 g	SB-RGB-700-K-B5
	870 x 30	745 mA RMS / 1.40 mA Peak	17.8 W					700 g	SB-RGB-910-K-B5
	220 x 30	195 mA RMS / 390 mA Peak	4.7 W					210 g	SB-RGB-251-K-B5
	440 x 30	385 mA RMS / 750 mA Peak	9.2 W					390 g	SB-RGB-481-K-B5
	660 x 30	565 mA RMS / 1,100 mA Peak	13.5 W			■	■	550 g	SB-RGB-701-K-B5
	870 x 30	745 mA RMS / 1.40 mA Peak	17.8 W					700 g	SB-RGB-911-K-B5

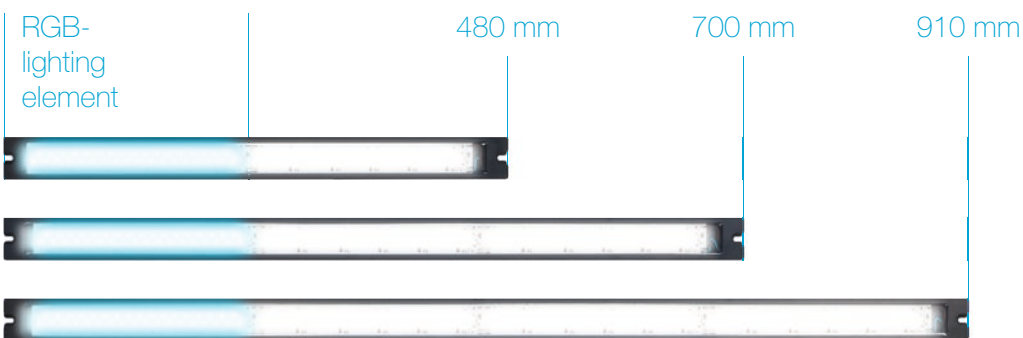

DIN
EN 12464-1

UL US
LISTED

Lighting with integrated control of power output

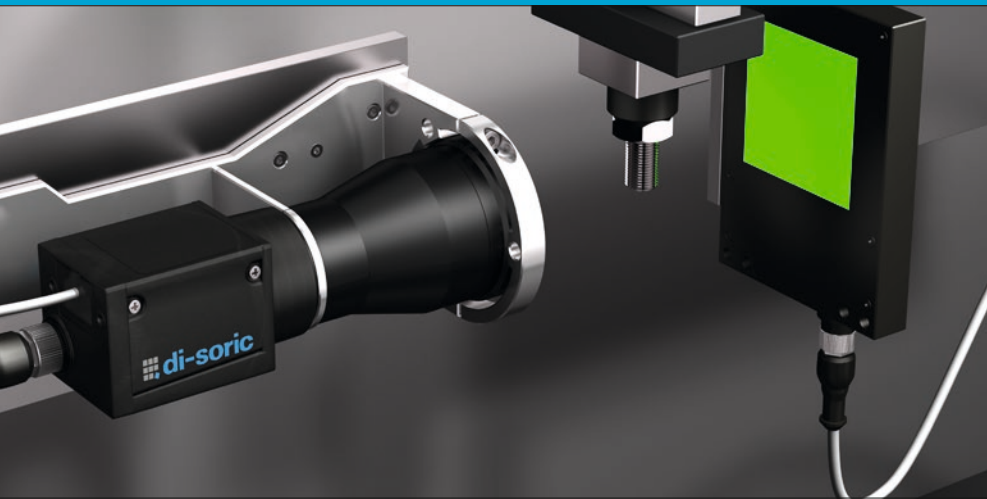

di-soric offers a comprehensive range of lighting products for supporting image processing systems and inspection tasks. These lighting systems feature exceptional technical characteristics in combination with extremely rugged housings and a high protection type.

Lighting

- Internal control of power output
- Homogeneous luminous field
- High IP 69K protection type
- External trigger input
- High efficiency
- Low levels of heat produced
- Light intensity can be adjusted
- Variety of fastening options
- Different light colors
- Sturdy housing design
- Standard M12 connector





Area lighting

Area light is used for background lighting and contour checking for contents such as wire spools, stamped parts and countless other objects that require contour monitoring. Individual versions to customer specifications can be provided.

Technical data (typ.)	+20°C, 24 VDC
Trigger input low level	0 to < 2.8 V
Trigger input high level	> 3.3 to 35 V
Plug connector	M12
Connection cable	VK... (optionally available)



	Illuminated area (mm)	Dispersion angle (°)	Size / housing design (mm)	Service voltage (VDC)	Ambient temperature (°C)	Integrated control of power output	Light intensity can be adjusted	Trigger	Protection type	Housing material	Light color	Product description
Area lighting												
	30 x 30	–	30 x 30 x 20	24	0 to +40				IP 67	Aluminum Black Anodized	<input checked="" type="checkbox"/> Red <input type="checkbox"/> White	BEK-F30/30RL-G1-K-BS BE-F30/30RL-G5-K-BS
	50 x 50	–	50 x 50 x 20	24	0 to +40				IP 67	Aluminum Black Anodized	<input checked="" type="checkbox"/> Red <input type="checkbox"/> White	BE-F50/50RL-G1-K-BS BE-F50/50RL-G5-K-BS
	50 x 50	–	80 x 110 x 15	15 to 35	0 to +50	■	■	■	IP 67	Aluminum Black Anodized	<input checked="" type="checkbox"/> Infrared	BEK-F50/50-G0TI-IBS
				15 to 35							<input checked="" type="checkbox"/> Red	BEK-F50/50-G1TI-IBS
				18 to 35							<input checked="" type="checkbox"/> Green	BEK-F50/50-G2TI-IBS
				18 to 35							<input checked="" type="checkbox"/> Blue	BEK-F50/50-G3TI-IBS
				18 to 35							<input type="checkbox"/> White	BEK-F50/50-G5TI-IBS
	100 x 100	–	130 x 160 x 15	15 to 35	0 to +50	■	■	■	IP 67	Aluminum Black Anodized	<input checked="" type="checkbox"/> Infrared	BEK-F100/100-G0TI-IBS
				15 to 35							<input checked="" type="checkbox"/> Red	BEK-F100/100-G1TI-IBS
				18 to 35							<input checked="" type="checkbox"/> Green	BEK-F100/100-G2TI-IBS
				18 to 35							<input checked="" type="checkbox"/> Blue	BEK-F100/100-G3TI-IBS
				18 to 35							<input type="checkbox"/> White	BEK-F100/100-G5TI-IBS
	150 x 150	–	180 x 210 x 15	15 to 35	0 to +50	■	■	■	IP 67	Aluminum Black Anodized	<input checked="" type="checkbox"/> Infrared	BEK-F150/150-G0TI-IBS
				15 to 35							<input checked="" type="checkbox"/> Red	BEK-F150/150-G1TI-IBS
				18 to 35							<input checked="" type="checkbox"/> Green	BEK-F150/150-G2TI-IBS
				18 to 35							<input checked="" type="checkbox"/> Blue	BEK-F150/150-G3TI-IBS
				18 to 35							<input type="checkbox"/> White	BEK-F150/150-G5TI-IBS
	200 x 200	–	230 x 260 x 18	15 to 35	0 to +50	■	■	■	IP 67	Aluminum Black Anodized	<input checked="" type="checkbox"/> Infrared	BEK-F200/200-G0TI-IBS
15 to 35				<input checked="" type="checkbox"/> Red							BEK-F200/200-G1TI-IBS	
18 to 35				<input checked="" type="checkbox"/> Green							BEK-F200/200-G2TI-IBS	
18 to 35				<input checked="" type="checkbox"/> Blue							BEK-F200/200-G3TI-IBS	
18 to 35				<input type="checkbox"/> White							BEK-F200/200-G5TI-IBS	
Area lighting												
	250 x 250	–	317 x 317 x 23	24	0 to +40				IP 67	Aluminum Black Anodized	<input checked="" type="checkbox"/> Red <input type="checkbox"/> White	BEK-FL250/250-G1T-IBS BEK-FL250/250-G5T-IBS
	400 x 400	–	467 x 467 x 23	24	0 to +40				IP 67	Aluminum Black Anodized	<input checked="" type="checkbox"/> Red <input type="checkbox"/> White	BEK-FL400/400-G1T-IBS BEK-FL400/400-G5T-IBS
	1,000 x 1,000	–	1067 x 1067 x 23	24	0 to +40				IP 67	Aluminum Black Anodized	<input checked="" type="checkbox"/> Red <input type="checkbox"/> White	BEK-FL1000/1000-G1T-IBS BEK-FL1000/1000-G5T-IBS





Lighting with integrated control of power output

















Barlights





























Barlights are used for high-intensity, uniform lighting for camera systems and countless inspection tasks. Individual long versions to customer specifications can be provided.

Technical data (typ.)	+20 °C, 24 VDC
Trigger input low level	0 to < 2.8 V
Trigger input high level	> 3.3 to 35 V
Shock/vibration load	30 g / 10 – 55 Hz, 1 mm
Plug connector	M12
Connection cable	VK... (optionally available)



	Illuminated area / length (mm)	Dispersion angle (°)	Size / housing design (mm)	Service voltage (VDC)	Ambient temperature (°C)	Integrated control of power output	Light intensity can be adjusted	Trigger	Protection type	Housing material	Light color	Product description
	30 x 30	–	30 x 30 x 20	24	0 to +40				IP 67	Aluminum Black Anodized	 Red  White	BE-A30/30-G1-K-BS BE-A30/30-G5-K-BS
	50 x 50	–	50 x 50 x 20	24	0 to +40				IP 67	Aluminum Black Anodized	 Red  White	BE-A50/50-G1-K-BS BE-A50/50-G5-K-BS

Barlights with SMD-LED												
	Illuminated area / length (mm)	Dispersion angle (°)	Size / housing design (mm)	Service voltage (VDC)	Ambient temperature (°C)	Integrated control of power output	Light intensity can be adjusted	Trigger	Protection type	Housing material	Light color	Product description
 SMD-LED	16 x 65	120°	16 x 20 x 84	24	0 to +40				IP 20	Aluminum Black Anodized	 Infrared	BE 1-A65/120-G0-K-BS
											 Red	BE 1-A65/120-G1-K-BS
											 Green	BE 1-A65/120-G2-K-BS
											 Blue	BE 1-A65/120-G3-K-BS
											 White	BE 1-A65/120-G5-K-BS
	16 x 130	120°	16 x 20 x 144	24	0 to +40				IP 20	Aluminum Black Anodized	 Infrared	BE 1-A130/120-G0-K-BS
											 Red	BE 1-A130/120-G1-K-BS
											 Green	BE 1-A130/120-G2-K-BS
											 Blue	BE 1-A130/120-G3-K-BS
											 White	BE 1-A130/120-G5-K-BS
	16 x 240	120°	16 x 20 x 254	24	0 to +40				IP 20	Aluminum Black Anodized	 Infrared	BE 1-A240/120-G0-K-BS
											 Red	BE 1-A240/120-G1-K-BS
											 Green	BE 1-A240/120-G2-K-BS
											 Blue	BE 1-A240/120-G3-K-BS
											 White	BE 1-A240/120-G5-K-BS

	Illuminated area / length (mm)	Dispersion angle (°)	Size / housing design (mm)	Service voltage (VDC)	Ambient temperature (°C)	Integrated control of power output	Light intensity can be adjusted	Trigger	Protection type	Housing material	Light color	Product description
Barlights 3mm LED												
	16 x 130	–	16 x 20 x 144	24	0 to +40				IP 20	Aluminum Black Anodized	 Infrared  Red  Green  Blue  White	BE 1-A130-G0-K-BS BE 1-A130-G1-K-BS BE 1-A130-G2-K-BS BE 1-A130-G3-K-BS BE 1-A130-G5-K-BS
	16 x 240	–	16 x 20 x 254	24	0 to +40				IP 20	Aluminum Black Anodized	 Infrared  Red  Green  Blue  White	BE 1-A240-G0-K-BS BE 1-A240-G1-K-BS BE 1-A240-G2-K-BS BE 1-A240-G3-K-BS BE 1-A240-G5-K-BS
Barlights												
	96 x 23	30°	40 x 60 x 113	18 to 30	0 to +40	■		■	IP 67	Aluminum Black Anodized	 Infrared  Red  Green  Blue  White	BEK-A100-G0T-K-BS BEK-A100-G1T-K-BS BEK-A100-G2T-K-BS BEK-A100-G3T-K-BS BEK-A100-G5T-K-BS
	296 x 23	30°	40 x 60 x 313	18 to 30	0 to +40	■		■	IP 67	Aluminum Black Anodized	 Infrared  Red  Green  Blue  White	BEK-A300-G0T-K-BS BEK-A300-G1T-K-BS BEK-A300-G2T-K-BS BEK-A300-G3T-K-BS BEK-A300-G5T-K-BS
	396 x 23	30°	40 x 60 x 413	18 to 30	0 to +40	■		■	IP 67	Aluminum Black Anodized	 Infrared  Red  White	BEK-A400-G0T-K-BS BEK-A400-G1T-K-BS BEK-A400-G5T-K-BS
	496 x 23	30°	40 x 60 x 513	18 to 30	0 to +40	■		■	IP 67	Aluminum Black Anodized	 Infrared  Red  White	BEK-A500-G0T-K-BS BEK-A500-G1T-K-BS BEK-A500-G5T-K-BS

Lighting with integrated control of power output

Spotlights

Our spot lights have a cone-shaped light beam and are used for external lighting of camera systems or for illuminating particular areas as well as a multitude of other applications.

Technical data (typ.)	+20 °C, 24 VDC
Trigger input low level	0 to < 2.8 V
Trigger input high level	> 3.3 to 35 V
Shock/vibration load	30 g / 10 – 55 Hz, 1 mm
Plug connector	M12
Connection cable	VK... (optionally available)



























	Illuminated area (mm)	Dispersion angle (°)	Size / housing design (mm)	Service voltage (VDC)	Ambient temperature (°C)	Integrated control of power output	Light intensity can be adjusted	Trigger	Protection type	Housing material	Light color	Product description
Spotlights												
		25°	M12 x 71	10 to 30	0 to +40	■		■	IP 67	Brass nickel plated	<input checked="" type="checkbox"/> Red <input type="checkbox"/> White	BEK-PM12-G1T-BS BEK-PM12-G5T-BS
	Ø21	7°	30 x 32 x 60	10 to 35	0 to +50	■	■	■	IP 67	Aluminum Black Anodized	<input checked="" type="checkbox"/> Infrared <input checked="" type="checkbox"/> Red <input checked="" type="checkbox"/> Green <input checked="" type="checkbox"/> Blue <input type="checkbox"/> White	BEK 1-P7-G0TI-IBS BEK 1-P7-G1TI-IBS BEK 1-P7-G2TI-IBS BEK 1-P7-G3TI-IBS BEK 1-P7-G5TI-IBS
	Ø21	10°	30 x 32 x 60	10 to 35	0 to +50	■	■	■	IP 67	Aluminum	UV light	BEK 1-P10-G7TI-IBS
	Ø21	14°	30 x 32 x 60	10 to 35	0 to +50	■	■	■	IP 67	Aluminum Black Anodized	<input checked="" type="checkbox"/> Infrared <input checked="" type="checkbox"/> Red <input checked="" type="checkbox"/> Green <input checked="" type="checkbox"/> Blue <input type="checkbox"/> White	BEK 1-P14-G0TI-IBS BEK 1-P14-G1TI-IBS BEK 1-P14-G2TI-IBS BEK 1-P14-G3TI-IBS BEK 1-P14-G5TI-IBS
	Ø21	30°	30 x 32 x 60	10 to 35	0 to +50	■	■	■	IP 67	Aluminum Black Anodized	<input checked="" type="checkbox"/> Infrared <input checked="" type="checkbox"/> Red <input checked="" type="checkbox"/> Green <input checked="" type="checkbox"/> Blue <input type="checkbox"/> White UV light	BEK 1-P30-G0TI-IBS BEK 1-P30-G1TI-IBS BEK 1-P30-G2TI-IBS BEK 1-P30-G3TI-IBS BEK 1-P30-G5TI-IBS BEK 1-P30-G7TI-IBS

Ringlights

Ringlights are used in combination with camera systems and ensure high-intensity, uniform illumination of the area to be inspected thanks to the illuminating LEDs arranged in a ring shape around the camera.

Technical data (typ.)	+20°C, 24 VDC
Trigger input low level	0 to < 2.8 V
Trigger input high level	> 3.3 to 35 V
Shock/vibration load	30 g / 10 – 55 Hz, 1 mm
Plug connector	M12
Connection cable	VK... (optionally available)



	Illuminated area (mm)	Dispersion angle (°)	Size / housing design (mm)	Service voltage (VDC)	Ambient temperature (°C)	Integrated control of power output	Light intensity can be adjusted	Trigger	Protection type	Housing material	Light color	Product description	
	Ø 30	90°	Ø69x20	24	0 to +40				IP 67	Aluminum Black Anodized	 Infrared  Infrared	BE-R30-G0-K-BS-CLR ¹⁾ BE-R30-G0-K-BS-DIF ²⁾	
	Ø 30	80°	Ø69x20	24	0 to +40				IP 67	Aluminum Black Anodized	 Red  Red  Red	BE-R30-G1-K-BS-CLR ¹⁾ BE-R30-G1-K-BS-DIF ²⁾ BE-R30-G1-K-BS-POL ³⁾	
	Ø 30	80°	Ø69x20	24	0 to +40				IP 67	Aluminum Black Anodized	 White  White  White	BE-R30-G5-K-BS-CLR ¹⁾ BE-R30-G5-K-BS-DIF ²⁾ BE-R30-G5-K-BS-POL ³⁾	
		Ø70	30°	Ø130x29	18 to 35	0 to +40	■	■	■	IP 67	Aluminum Black Anodized	 Infrared  Infrared	BEK-R70/30-G0TI-IBS-CLR ¹⁾ BEK-R70/30-G0TI-IBS-DIF ²⁾
		Ø70	30°	Ø130x29	18 to 35	0 to +40	■	■	■	IP 67	Aluminum Black Anodized	 Red  Red  Red	BEK-R70/30-G1TI-IBS-CLR ¹⁾ BEK-R70/30-G1TI-IBS-DIF ²⁾ BEK-R70/30-G1TI-IBS-POL ³⁾
		Ø70	20°	Ø130x29	18 to 35	0 to +40	■	■	■	IP 67	Aluminum Black Anodized	 Green  Green  Green	BEK-R70/20-G2TI-IBS-CLR ¹⁾ BEK-R70/20-G2TI-IBS-DIF ²⁾ BEK-R70/20-G2TI-IBS-POL ³⁾
		Ø70	20°	Ø130x29	18 to 35	0 to +40	■	■	■	IP 67	Aluminum Black Anodized	 Blue  Blue  Blue	BEK-R70/20-G3TI-IBS-CLR ¹⁾ BEK-R70/20-G3TI-IBS-DIF ²⁾ BEK-R70/20-G3TI-IBS-POL ³⁾
		Ø70	120°	Ø130x29	18 to 35	0 to +40	■	■	■	IP 67	Aluminum Black Anodized	 White  White  White	BEK-R70/120-G5TI-IBS-CLR ¹⁾ BEK-R70/120-G5TI-IBS-DIF ²⁾ BEK-R70/120-G5TI-IBS-POL ³⁾

¹⁾ Clear protection window

²⁾ Diffusor panel

³⁾ Polarizer panel

Lighting with integrated control of power output

Coaxial lights

Coaxial lights couple the light into the camera system's optical light path from the side using a semi-transparent mirror. The object being tested returns the reflected light to the camera through the mirror. The light produced by a coaxial light is ideal for reflective, metallic or shiny objects, such as when testing directly applied data matrix codes on metal parts or testing PCBs, silicon wafers or reflective stickers.

Technical data (typ.)	+20 °C, 24 VDC
Trigger input low level	0 to < 2.8 V
Trigger input high level	> 3.3 to 35 V
Shock/vibration load	30 g / 10 – 55 Hz, 1 mm
Plug connector	M12
Connection cable	VK... (optionally available)













	Illuminated area (mm)	Dispersion angle (°)	Size / housing design (mm)	Service voltage (VDC)	Ambient temperature (°C)	Integrated control of power output	Light intensity can be adjusted	Trigger	Protection type	Housing material	Light color	Product description
	50 x 50	-	62 x 58 x 103.5	18 to 35	0 to +40	■	■	■	IP 20	Aluminum Black Anodized	■ Red	BEK-K50/50-G1TI-IBS
											■ Green	BEK-K50/50-G2TI-IBS
											■ Blue	BEK-K50/50-G3TI-IBS
											□ White	BEK-K50/50-G5TI-IBS

Darkfield lights

Darkfield lights feature a flat angle of incidence on the illuminated surface. Changes to the surface, such as scratches, stampings, embossings or ridges change the beam input of the light, reflecting or scattering the light as a result. These changes to the surface differ significantly and can be detected with the aid of a camera system.

Technical data (typ.)	+20°C, 24 VDC
Trigger input low level	0 to < 2.8 V
Trigger input high level	> 3.3 to 35 V
Shock/vibration load	30g/10–55Hz, 1 mm
Plug connector	M12
Connection cable	VK... (optionally available)



	Illuminated area (mm)	Dispersion angle (°)	Size / housing design (mm)	Service voltage (VDC)	Ambient temperature (°C)	Integrated control of power output	Light intensity can be adjusted	Trigger	Protection type	Housing material	Light color	Product description
	Ø 70	–	95 x 130 x 12	10 to 35	0 to +40	■	■	■	IP 67	Aluminum Black Anodized	 Infrared  Red  Green  Blue <input type="checkbox"/> White	BEK-D70-G0TI-K-BS BEK-D70-G1TI-K-BS BEK-D70-G2TI-K-BS BEK-D70-G3TI-K-BS BEK-D70-G5TI-K-BS
	Ø 120	–	170 x 200 x 15	10 to 35	0 to +50	■	■	■	IP 67	Aluminum Black Anodized	 Infrared  Red  Green  Blue <input type="checkbox"/> White	BEK 1-D120-G0TI-IBS BEK 1-D120-G1TI-IBS BEK 1-D120-G2TI-IBS BEK 1-D120-G3TI-IBS BEK 1-D120-G5TI-IBS

Flash controllers and lights



The di-soric flash controller BC-100-20A allows the LEDs to "over-drive" with several times the power, increasing the light intensity many times over.

This enables shorter exposure times for freezing object movement or the option to select a higher f-number for more depth of field during the same exposure time. More light in the application also reduces outside interference. Even interference due to external scattered light is significantly reduced by overdriving the lights.



Lights for flash controllers

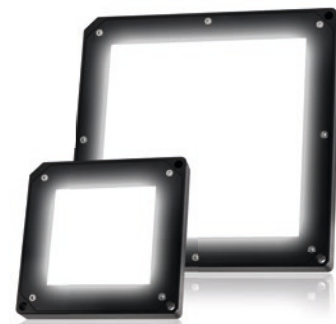

- High excess current factor
- Flash mode operation for "freezing images" and inspection of fast moving objects at extremely high light intensity
- Intelligent thermal management for a long life
- Homogeneous luminous field
- Protection class IP 67
- Robust metal housing

Flash controller for flashable lighting

- Controlled flash mode for LED lights
- Simple and fast setup with RS485/USB/PC
- Trigger input for external control
- Adjustable trigger delay
- Max. pulse current 20A
- Pulse times can be adjusted between 10 μs and 50 ms
- Strobe function up to 10kHz
- Constant current of up to 1.8A
- Standby output
- Trigger output for camera systems and peripheral devices

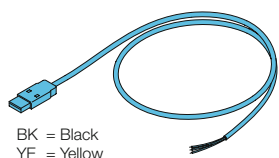

Technical data (typ.)	+20°C, 24 VDC
Service voltage	24 V DC ± 1
Trigger input	5 to 24 V DC potential-free, optocouplers
Trigger output	12V DC, push-pull, pnp, npn configurable (max. 150 mA)
Ready output	12V DC, push-pull, pnp, npn configurable (max. 150 mA)
Input power at 24VDC	Max. 55W
Protection class	III, operation on protective low voltage
Inverse polarity protection	In pairs by terminal group
Short-circuit protection	In pairs by terminal group
Operating display	LED: Green, LED: Yellow (flashing), LED: Red (fault)
Shock/vibration load	10 to 55 Hz / 1.0 mm / 30 g
Ambient temperature	0 to +40°C
Protection type	IP 40
Housing material	Aluminum anodized, PA 6.6 FR

Flash controller for flashable lighting									Product description
	< 2.5 A 6.0A	0.1 to 1.8 A	0.1 to 20.0 A	10 μs to 50 ms	100 μs to 60s	≥50 μs (0 to 2 A) ≥5 μs (2 to 20A)	■	12-pin	BC-100-20A
Requirements for the power unit									
24VDC, 6A									
Interface adapter 1.8m, RS485/USB									
									
GND Data-(B) Data+(A)	BK = Black YE = Yellow OG = Orange								RS485-1.8-USB

Flash controllers and lights

Barlights for flash controllers

are used for background illumination and contour inspection for countless objects that require an exceptionally high light intensity for quality monitoring. Individual versions to customer specifications can be provided.



Technical data (typ.)	+20 °C, 24 VDC
Service voltage	Operation only with flash controller
Risk group	Clear (DIN EN 62471)
Protection class	III, operation on protective low voltage
Shock/vibration load	30 g / 10 – 55 Hz, 1 mm
Ambient temperature	0 to +50 °C
Insulation voltage endurance	500 V
Housing material	Aluminum, black anodized
Connection	Cable PUR 2.5 m

	Illuminated area/length (mm)	Dispersion angle (°)	Size / housing design (mm)	Ambient temperature (C°)	Pulse power consumption (W)	Pulse overload factor	Pulse current-carrying capacity (mA)	Protection type	Window material	Window	Light color	
Area lights for flash controllers												Product description
	50 x 50	-	80 x 80 x 13	0 to 50	Max. 135	Max. 18	Max. 6,400	IP 67	PC, opal	Diffuse	Infrared	BE-F50/50-F0-K
					Max. 25	Max. 6.4	Max. 1,600				Red	BE-F50/50-F1-K
					Max. 40	Max. 8	Max. 1,600				White	BE-F50/50-F5-K
	100 x 100	-	130 x 130 x 13	0 to 50	Max. 275	Max. 18	Max. 12,800	IP 67	PC, opal	Diffuse	Infrared	BE-F100/100-F0-K
					Max. 48	Max. 6.4	Max. 3,200				Red	BE-F100/100-F1-K
					Max. 80	Max. 9	Max. 3,200				White	BE-F100/100-F5-K
	150 x 150	-	180 x 180 x 13	0 to 50	Max. 460	Max. 19	Max. 19,200	IP 67	PC, opal	Diffuse	Infrared	BE-F150/150-F0-K
					Max. 80	Max. 6.6	Max. 4,800				Red	BE-F150/150-F1-K
					Max. 125	Max. 9.6	Max. 4,800				White	BE-F150/150-F5-K
	200 x 200	-	230 x 230 x 13	0 to 50	Max. 500	Max. 18	Max. 19,900	IP 67	PC, opal	Diffuse	Infrared	BE-F200/200-F0-K
					Max. 120	Max. 9	Max. 6,400				Red	BE-F200/200-F1-K
					Max. 180	Max. 9	Max. 6,400				White	BE-F200/200-F5-K

Barlights for flash controllers

are used for high-intensity, uniform lighting for camera systems and countless inspection tasks.

Individual long versions to customer specifications can be provided.



Technical data (typ.)

+20°C, 24 VDC

Service voltage	Operation only with flash controller
Risk group	Clear (DIN EN 62471)
Protection class	III, operation on protective low voltage
Shock/vibration load	30 g / 10 – 55 Hz, 1 mm
Ambient temperature	0 to +50°C
Insulation voltage endurance	500 V
Housing material	Aluminum, black anodized
Connection	Cable PUR 2.5 m

	Illuminated area/length (mm)	Dispersion angle (°)	Size / housing design (mm)	Ambient temperature (C°)	Pulse power consumption (W)	Pulse overload factor	Pulse current-carrying capacity (mA)	Protection type	Window material	Window	Light color	
Barlights for flash controllers												Product description
	16 x 130	–	16 x 20 x 144	0 to 40	31	8	1,350	IP 20			<input checked="" type="checkbox"/> Red	BE-A130-F1-K
					35	10	1,400				<input type="checkbox"/> White	BE-A130-F5-K

Accessories for BE-A 130 ...

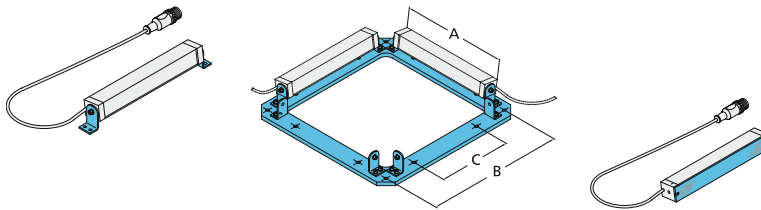

Matching accessories
See chapter
Accessories

	46 x 95	–	60 x 40 x 113	0 to 40	290	9.33	20,000	IP 67	PMMA	Clear	<input checked="" type="checkbox"/> Infrared	BE-A100-F0-K
					240	8.0	8,000				<input checked="" type="checkbox"/> Red	BE-A100-F1-K
					250	8.0	8,000				<input type="checkbox"/> White	BE-A100-F5-K
	46 x 295	–	60 x 40 x 313	0 to 40	1,500	24	60,000	IP 67	PMMA	Clear	<input checked="" type="checkbox"/> Infrared	BE-A300-F0-K
					720	12	24,000				<input checked="" type="checkbox"/> Red	BE-A300-F1-K
					750	12	24,000				<input type="checkbox"/> White	BE-A300-F5-K

Accessories for BE-A 100 ... / BE-A 300 ...

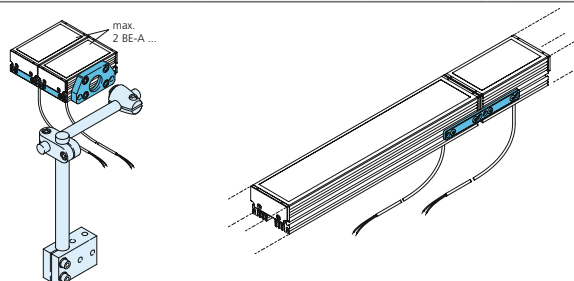

Matching accessories
See chapter
Accessories

Flash controllers and lights

Ringlights for flash controllers

Ringlights for lighting controllers are used in combination with camera systems and feature extremely high light intensity. The lighting LEDs arranged in a ring shape around the camera system ensure uniform and high-intensity illumination of the area to be inspected.



Technical data (typ.)	+20 °C, 24 VDC
Service voltage	Operation only with flash controller
Risk group	Clear (DIN EN 62471)
Protection class	III, operation on protective low voltage
Shock/vibration load	30 g / 10 – 55 Hz, 1 mm
Ambient temperature	0 to +50 °C
Insulation voltage endurance	500 V
Housing material	Aluminum, black anodized
Connection	Cable PUR 2.5 m

	Illuminated area/length (mm)	Dispersion angle (°)	Size / housing design (mm)	Ambient temperature (C°)	Pulse power consumption (W)	Pulse overload factor	Pulse current-carrying capacity (mA)	Protection type	Window material	Window	Light color	Product description
	Ø30	30°	Ø69x20	0 to 40	Max. 30	8	Max. 2,000	IP 67	PMMA	Clear	<input checked="" type="checkbox"/> Red	BE-R30-F1-K-CLR
										Diffuse	<input checked="" type="checkbox"/> Red	BE-R30-F1-K-DIF
										Polarized	<input checked="" type="checkbox"/> Red	BE-R30-F1-K-POL
	Ø30	120°	Ø69x20	0 to 40	Max. 45	10	Max. 2,000	IP 67	PMMA	Clear	<input type="checkbox"/> White	BE-R30-F5-K-CLR
										Diffuse	<input type="checkbox"/> White	BE-R30-F5-K-DIF
										Polarized	<input type="checkbox"/> White	BE-R30-F5-K-POL
	Ø70	30°	Ø130x20	0 to 40	Max. 96	8	Max. 6,000	IP 67	PMMA	Clear	<input checked="" type="checkbox"/> Red	BE-R70-F1-K-CLR
										Diffuse	<input checked="" type="checkbox"/> Red	BE-R70-F1-K-DIF
										Polarized	<input checked="" type="checkbox"/> Red	BE-R70-F1-K-POL
	Ø70	120°	Ø130x20	0 to 40	Max. 140	10	Max. 6,000	IP 67	PMMA	Clear	<input type="checkbox"/> White	BE-R70-F5-K-CLR
										Diffuse	<input type="checkbox"/> White	BE-R70-F5-K-DIF
										Polarized	<input type="checkbox"/> White	BE-R70-F5-K-POL
	Ø130	30°	Ø200x20	0 to 40	Max. 230	8	Max. 12,000	IP 67	PMMA	Clear	<input checked="" type="checkbox"/> Red	BE-R130-F1-K-CLR
										Diffuse	<input checked="" type="checkbox"/> Red	BE-R130-F1-K-DIF
										Polarized	<input checked="" type="checkbox"/> Red	BE-R130-F1-K-POL
	Ø130	120°	Ø200x20	0 to 40	Max. 275	10	Max. 11,000	IP 67	PMMA	Clear	<input type="checkbox"/> White	BE-R130-F5-K-CLR
										Diffuse	<input type="checkbox"/> White	BE-R130-F5-K-DIF
										Polarized	<input type="checkbox"/> White	BE-R130-F5-K-POL

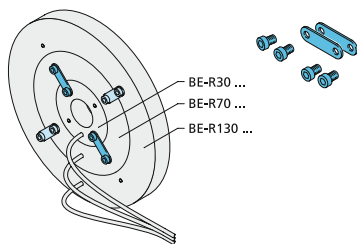

For connection of lights of the next size to a unit in pairs

Set consists of two connecting elements and four M4x6 cheese-head screws. For installing all three lights into one unit, two BE-R-MOUNTINGSETS are needed.

BE-R-MOUNTINGSET

Customized lighting



We review the special requirements related to size and design, light color and connectivity with you and carry out small production runs of customized products on request.



Does your application have limited installation space available?

Do you require special lighting for image processing?

Are the standard devices from our product line unable to meet the special requirements your application needs?

Our special customer-specific lights give you a cost-effective option for meeting the particular needs of your application.

Our custom lights give you maximum process reliability for your specific image processing application.

And at the same extremely high di-soric level of quality.



Bring your challenge to us. We work with you.



CS 50 Vision Sensor—the world's smallest vision sensor—offers powerful performance with easy handling for countless verification tasks in industrial applications, including top performance for completeness checks, rotation verifications, presence checks, counting objects and much more.



CS 50 Vision Sensor

- Maximum performance with up to 2520 checks/minute
- Image export over FTP
- Interchangeable light, filter and polarizer
- Option of simultaneous feature detection and measurement of multiple objects
- Profinet / Ethernet-IP / TCP-IP / RS 232
- Multilingual, intuitive software
- Part detection, presence, measurement, positioning, counting and logic

5 efficient tools for a variety of tasks:



Locating / Part detection

The Locate tool dynamically finds an unlimited amount of samples within a freely selectable image section—simultaneously.



Counting

The Count tool counts objects that have been taught into an image and is ideal for tasks such as verifying the correct number of parts within a workpiece carrier.



Presence

The Presence tool detects the presence/absence of a feature based on pixel values/contrast.



Measuring

The Measure tool carries out pixel-based height or width measurements between edges or points. Angle measurements can also be carried out.















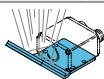

Logic

The Logic tool makes it possible to make connections among CS 50 Boolean results simply and logically.



Technical data (typ.)		at +20 °C, 24 VDC	
Service voltage	4.75 to 30V DC	Number of inputs/outputs	1/3
No-load current	150mA, (24VDC)	External trigger input	off = < 1.0 V (ON input)
Dimensions (H x W x D)	25.4 x 44.5 x 44.5 mm	Inspection tasks	Locating, counting, presence, measuring, logic
Control buttons	1	Equipment	Internal trigger
Interchangeable light	Yes (red, white, blue, infrared)		External trigger input
Ambient temperature	0 to +40 °C		PC software setup
Protection type	IP 65, IP 67		Logic for user-defined outputs
Protection class	III, operation on protective low voltage		Highest resolution (640 x 480 pixels)
Housing material	Aluminum, black	Image output	b/w, VGA
Weight	68 g	Number of jobs	Unlimited (1.4 GB)
Vibration/shock resistance	55Hz sine / 2,000Hz random / 50g		1 -255 for operation with Profinet
		Exposure time	66 to 58.825 µs

	Focal length (mm)	Working distance (mm)	Light color	Max. part speed (images/sec)	Profinet	RS 232	Ethernet / IP	TCP/IP	Product description
Vision Sensor									
	5 / 10	50 to 300	 High power, red	42	■	■	■	■	CS 50 BM2-2-ES-G1
			 High power, white						CS 50 BM2-2-ES-G5
	16 / 32	50 to 150	 High power, red	42	■	■	■	■	CS 50 BM2-4-ES-G1
			 High power, white						CS 50 BM2-4-ES-G5
90° attachment mirror									
									CS-R90
LED board replacement kit									
			 Infrared						BE-CS-G0
			 Red (625nm)						BE-CS-G1
			 Blue (470nm)						BE-CS-G3
			 White (6500K)						BE-CS-G5
Windows									
	Transparent plate		Clear						CS-WINDOWKIT
	For eliminating surface reflections		Diffuser						CS-WINDOWKIT-DIF
			Polarizer						CS-WINDOWKIT-POL
Filter									
	For increasing contrast		 Red						CS-WINDOWKIT-G1
			 Blue						CS-WINDOWKIT-G3
USB stick									
	Software and documentation for CS 50 (alternatively available at www.di-soric.com)								USB stick CS50

High power attachment light





- Easy to install
- High-intensity light pulse in red/white/IR light colors
- Automatic trigger signal from CS 50 Vision Sensor
- Attachment window optionally available



NEW

Technical data (typ.)

		+20 °C	
Service voltage	22 to 30V DC	Ambient temperature	0 to +40 °C
Protection type	IP 67	Housing material	Aluminum, black anodized
Protection class	III, operation on protective low voltage	Window material	PMMA, clear
Shock/vibration load	30 g/10-55Hz, 1 mm	Plug connector	M12

Ringlights	Dispersion angle	Light color	Risk group (DIN EN 62471)	Light intensity			Power At 24VDC (W)	Weight (g)	Product description
				At 0.1 m	At 0.3 m	At 0.5 m			
	90°	 Infrared, 850 nm	Open	11,800 µW/cm ²	1,720 µW/cm ²	640 µW/cm ²	23	80	BEK-R33-E0T-K-BS
	80°	 Red, 625 nm	Open	29,000 lux	3,370 lux	1,450 lux	23	80	BEK-R33-E1T-K-BS
	80°	 White, 6,000K	Open	51,300 lux	7,100 lux	2,500 lux	23	80	BEK-R33-E5T-K-BS

Accessories for operating the CS 50 with a ringlight BEK-R33 ...

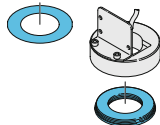
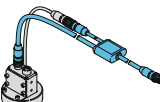
	Polarization film for affixing to the ringlight BEK-R33 ...	BEK-R33-POL
	Focus optics for use with the ringlight BEK-R33 ...	BEK-R33-FOK
	Y-distributor cable for CS 50 and BEK-R33	CS-Y-0.3/12-A

For the comprehensive range of accessories, see the Accessories chapter

Comprehensive range of accessories
See chapter Accessories

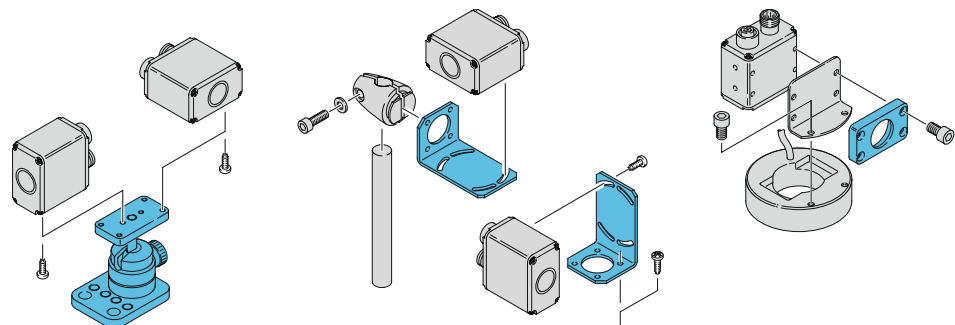

mm (typ.)

Multi-functional control panel









- Rugged housing design
- Visualization of all image and evaluation data
- Easy-to-use rights management
- Job switching on-the-fly
- Remote access over VNC
- Multi-camera mode
- Customer-specific design adjustment
- Multi-lingual user interface

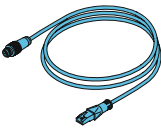

NEW
MEM

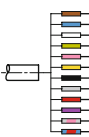

Technical data (typ.)	at +20°C		
Mounting	M4 stud bolts (6x)	Functions	
Operating principle	Embedded touch screen monitor	Communication with camera	CloudLink/Telnet-based
	ARM/Linux-based	Change for camera jobs	Using touch screen
Service voltage	24±5% VDC	Interaction with camera settings	Using touch screen
Ambient temperature	0 to +40°C	Interaction with a job	Using all linked variables/no
For use with	Vision Sensors CS 50	Interfaces	telnet, REST Api, HTTP
Connection	RJ45 (network)	Base languages	German, English, French
	2-pin connector (power supply)		Spanish, Italian and more
Selection of data communication to the camera	All variables linked in AutoVision can be displayed/manipulated		

	Screen diagonal	Ethernet	I/O	Coupling	Cable length (m)	Connector	Protection type	Cable material	Drag chain compatible	Product description
Multi-functional control panel										
	7" 10"						IP 65 (front side)			VP 700 VP 1000
Ethernet cable										
		■			2.0 5.0 10.0 10.0		IP 67 IP 67 IP 67 P 67	PUR PUR PUR PUR		VKHM-Z-2/RJ45 VKHM-Z-5/RJ45 VKHM-Z-10/RJ45 VKHM-W-5/RJ45
I/O cable										
			■		5.0 5.0 10.0 15.0 20.0 5.0		IP 67 IP 67 IP 67 IP 67 IP 67 IP 67	PVC PUR PUR PUR PUR PUR		VKHM-Z-5/12-A VKSM-Z-5/12-A VKSM-Z-10/12-A VKSM-Z-15/12-A VKSM-Z-20/12-A VKHM-W-5/12-A-CS
I/O extension cable										
			■		5.0		IP 67	PVC		VSM-Z-5/VKM-Z/12-A



” A successful overall image processing solution consists of components that are high-quality and precisely coordinated to each other, paired with expertise and the corresponding knowledge of the boundary conditions. “



di-soric Solutions is a part of the di-soric group of companies and focuses on consultation and configuration for image processing projects as well as integrating automation solutions using image processing and industrial identification.

We ensure the quality of products manufactured in automated processes and provide for complete traceability during the individual process steps. We work with powerful systems and work with you to determine the most effective and efficient solution.

Continuous further development of our products and services, constant awareness of quality and competent consultation ensure that your processes deliver the highest quality.





Consultation

Determining each and every one of your tasks and paying careful attention to the specific process steps involved ensures that implementation is a success.

For this reason, competent consultation takes top priority. Our comprehensive experience and precise approach make complex matters easily intelligible for you.

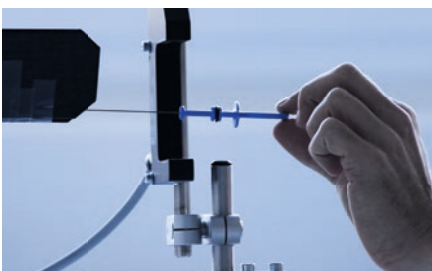

Integration

Every image processing and identification solution from di-soric Solutions is fully implemented into your system and brought into operation in accordance with your requirements. That way, you are free to concentrate on your core strengths – your products and services.

We take over programming and adjustment work while providing you with turn-key concepts and implementing them.

Our references attest to the high quality of our products and services alike.

Feasibility testing

Every task has its own challenges. Once secure function has been guaranteed, the steps that follow involve optimized process integration. We openly address your compulsory requirements, test them with well-founded expertise and provide you with the best possible setup of coordinated hardware and software.

We give you the results of the research and show you the path to the solution in detail. Risks and their countermeasures are also presented with transparency.



Service

We consider ourselves to be a comprehensive partner to our customers throughout the entire duration of the application.

We are happy to handle professional system maintenance, necessary adjustment work, modifications and extensions on site as well as remote maintenance. We view fast and reliable customer service as an integral part of proximity to the customer.

Engineering

Our expertise in industrial image processing and identification provides you with critical added value for continuous applications.

We develop custom solutions, which are configured and ready for use upon delivery.

We secure your production process smoothly by developing and programming a target-oriented and efficient automated image processing and identification solution based on your manufactured parts.

We place a great deal of value on modularity so that our solutions ensure high flexibility, even for your future requirements.



Training programs

Do you want to continuously increase the quality of your products as well?

We are happy to give you access to all of our expertise and years of experience. You will gain knowledge from us that you cannot find in textbooks. With only one goal in mind:

To make you even better.

The visual development environment for industrial image processing.

nVision's speed and performance capacity along with its custom adjustment options give you the right solution for your job in image processing.

nVision features a groundbreaking, intuitive, visually engaging user interface and reliable software.



nVision is the result of over 20 years of experience in the area of image processing. We are continuously developing it using modern, powerful programming languages. We consider the extremely diverse range of tasks and requirements that our customers have and integrate them into the solution.

The established software is used for industrial Machine Vision applications as well as scientific image analysis. The performance spectrum and flexibility have already shown their strengths at many companies in a variety of industries. In addition, we provide consultation during the feasibility analysis, undertake project implementation and provide you with support after the project ends in the form of service and further developments.

Our services range from visualization in the field of scientific research using interactive image analysis systems to fully automated Machine Vision applications, such as parts inspection, counting, measuring, barcode and matrix code decoding as well as OCR (Optical Character Reading).

Thanks to nVision, your projects can be implemented better and more quickly - ensuring more efficiency and profitability.

**SOLUTIONS.
CLEVER.
PRACTICAL.**



The easy-to-use image processing software for industry and science.

nVision is the unique and state-of-the-art culmination of 20 years of experience. nVision is a complete and flexible solution, making it perfect for your applications in image processing as well.



Functions

- Live data processing
- Automation of your application
- All pixel calculations either monochromatic or in color
- Barcode and Data Matrix identification
- Completeness check
- Interactive measuring
- Font recognition (OCR, OCV)
- Pattern detection
- Surface inspection
- Position detection and robot guidance
- Printed image control
- Color recognition/ color processing

Advantages

- Modern user interface
- Simple, intuitive and personalized operation
- Easy handling
- Top performance and stability
- Wide repertoire of functions
- Security for the resolvability of applications
- Less development time
- Time saving = Time-to-Market is shortened
- Supports a wide variety of cameras
- Easy integration into automated devices
- Individualized service and support

See it for yourself and call us up:
+49 7181 98 78-0

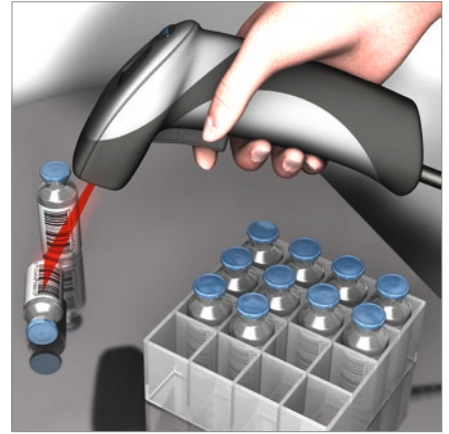
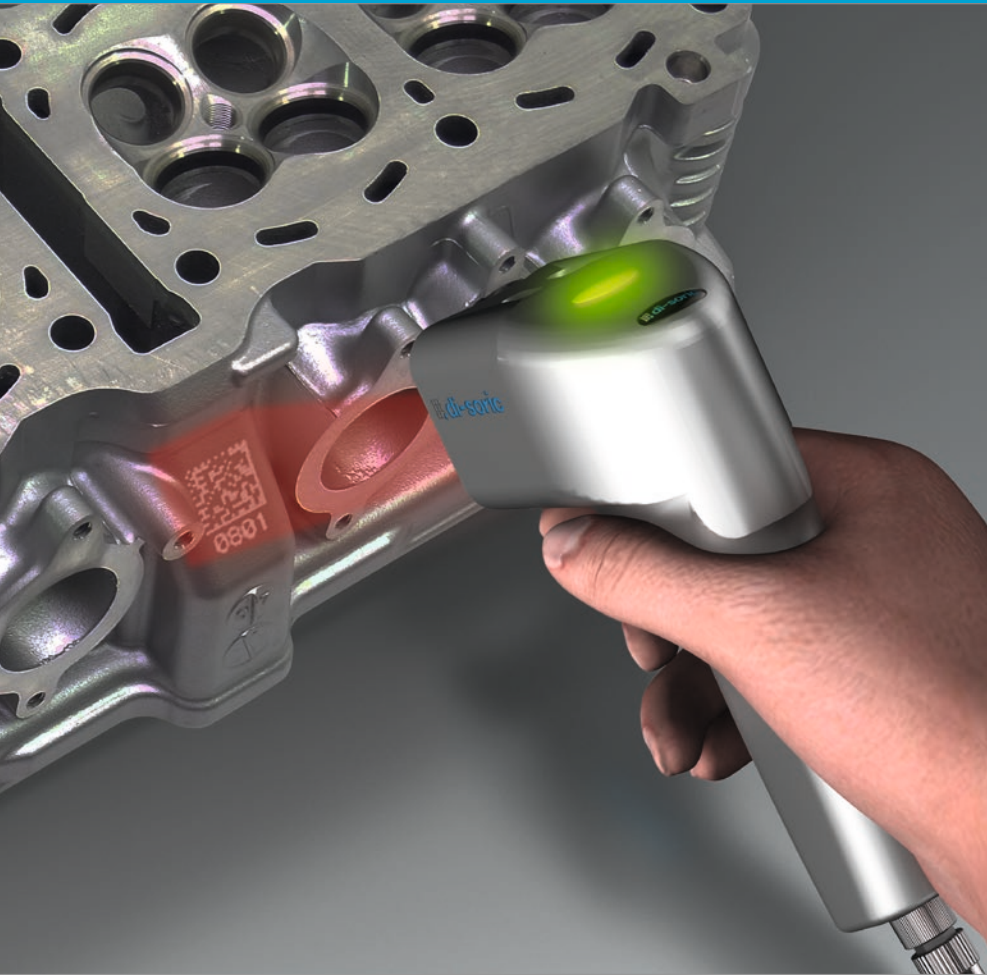

Handheld readers from di-soric Solutions offer a comprehensive range of high-performance portable code readers.







They feature extremely high-performance decoding algorithms and provide fast, efficient read operations within your track and trace applications. Our devices are cost-effective and we offer the perfect product for every application.

ID handheld reader

- ID 200—world's first ID reader made of aluminum
- Up to 10 decodes per second
- Devices with RS 232, USB or Bluetooth interface
- Handheld reader systems for any ambient conditions
- Rugged, ergonomic design
- ID-100 / ID-200:
Reads 1D and 2D symbologies, including DPM on difficult surfaces
- Serial or USB connection









Technical data (typ.)	at +20 °C
Image sensor	CMOS
Optics	Fixed optics

	Warranty	Target setup	ESD-capable	Resolution (pixels)	Service voltage (VDC)	Protection type	Housing material	Connection	RS-232	Bluetooth	USB	Product description
	2-year			960 x 640	5.0	IP 54	Plastic	Cable	■	■ ¹⁾	■	ID-10-IM3-2-US
	5-year	■		1280 x 960	5.0	IP 54	Plastic	Cable	■			ID-80-IM3-2-S
											■	ID-80-IM3-2-U
	3-year	■		1280 x 960	5.0	IP 54	Plastic	Cable	■		■ ¹⁾	ID-100-IM3-2-US
	3-year	■		1280 x 960	4.2	IP 65	Plastic	Wireless		■		ID-110-IM3-2-BT
	3-year	■	■	1280 x 960	5.0	–	Aluminum	Cable	■		■	ID-200-IM3-2-US

Accessories for ID handheld readers	
	Matching accessories See page(s) 164 / 165

¹⁾With separately available accessories

	ID-10-IM3-2-US	80-IM3-2-S	ID-80-IM3-2-U	ID-100-IM3-2-US	ID-110-IM3-2-BT	ID-200-IM3-2-US	Designation	Note	Cable length (m)	Product description
	Connection cable / converter									Product description
	■	■		■			Connection cable	RJ50 / Sub-D / DC Jack	2.4	ID-K-SD/DCJ-RJ50-2
	■		■	■	■		Connection cable	RJ50 / USB-A	1.8	ID-K-RJ50/U-2
						■	Connection cable	M12,12-pin / USB	2.0	ID-K-M12/U-2
						■	Connection cable	M12,12-pin / Sub-D/DC Jack	Coiled cord 2.0	ID-K-SD/DCJ-M12-2
						■	Connection cable	M12,12-pin / Sub-D/DC Jack	Coiled cord 5.0	ID-K-SD/DCJ-M12-5
				■		■	USB converter	Serial / USB Display: Operating LED	0.5	VS1K-K-S/U
			■		■	Serial Keyboard Converter	Serial / USB 9600 BPS German keyboard	1.8	Serial Keyboard Converter	
	Power supply unit and energy supply									Product description
	■	■		■	■	■	Power supply unit	Supply voltage: 230 V Service voltage: 5V DC		ID-PS-230/5V-DCJ
						■	Charging station	With holder for ID-110 handheld reader for charging an inserted ID-110-BAT replacement battery		ID-110-PS-Base
						■	Base /charging station	With holders for charging up to four ID-110-BAT replacement batteries		ID-110-BAT-CH-EU
					■	Replacement battery	Durable lithium-ion battery LED battery status display		ID-110-BAT	

	ID-10-IM3-2-US	80-IM3-2-S	ID-80-IM3-2-U	ID-100-IM3-2-US	ID-110-IM3-2-BT	ID-200-IM3-2-US	Designation	Note	Cable length (m)	
Data transmission module										
  	■			■			Bluetooth cable	Includes Bluetooth modem Class II / Bluetooth V2.1	1.8	ID-BT cable
					■		Base / charging station	Includes Bluetooth modem ID-BT interface-S		ID-110-PS/BT-BASE
					■		Bluetooth modem	For operation with ID-100-PS-Base charging station		ID-BT-Interface-S
Brackets										
  	■						Stand foot	Material: Plastic		ID-10-STAND
		■	■	■			Wall bracket	Material: POM		ID-100-WBKT
						■	Wall bracket	Material: POM		ID-200-WBKT
						■	Wall bracket	Material: POM conductive ESD-Safe		ID-200-WBKT-ESD
Protective cover sets										
						■	ID-200 protective cover set	For the protection of the optics and lighting against contamination and damage Material: POM / glass		ID-200-CVR-SET
						■	ID-200 protective cover set	For the protection of the optics and lighting against contamination and damage Material: POM / glass ESD-Safe		ID-200-CVR-SET-ESD

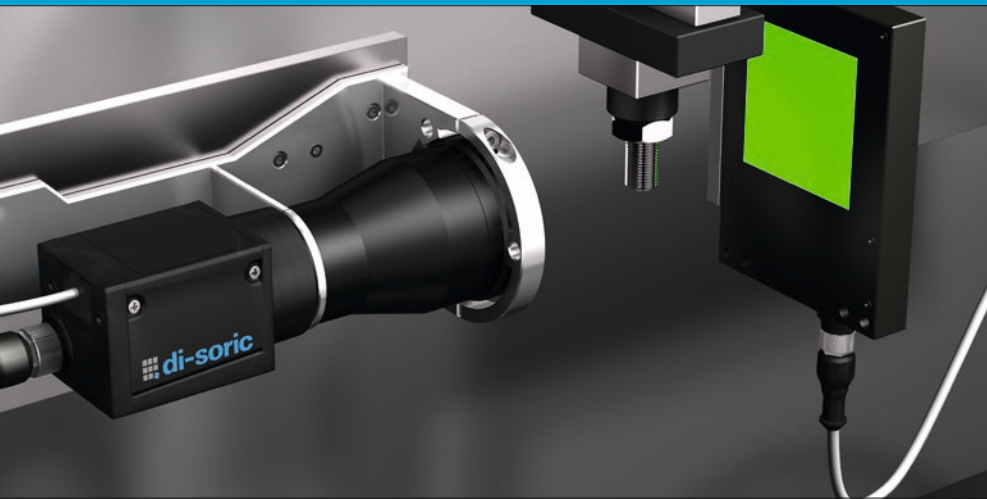

di-soric Solutions lenses are used in a variety of applications and feature an extremely rugged mechanical design. All lenses have a standardized C-mount connection, lock screws for focus and iris adjustment and a compact design. Low distortion, high image contrasts and high light transmission set these lenses apart.

Lenses

- Standardized C-mount connection
- Various focal lengths from 3.5 to 100 mm
- Compact design
- Lock screws for focus and iris adjustment
- Option for attaching filters on all models

Filter and protective glass for all lenses

- Bandpass filter
- Cutoff filter
- Daylight cutoff filter
- Neutral density filter
- Polarized filter
- Lens protective glass



Lenses

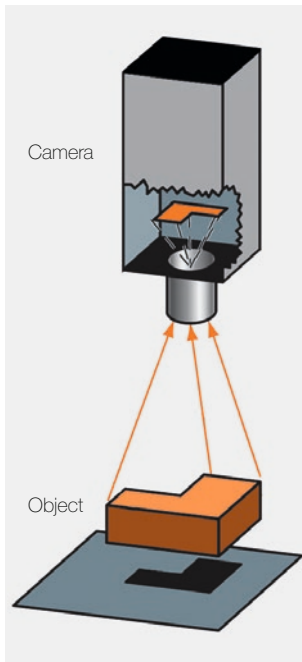

di-soric Solutions lenses are used in a variety of applications and feature an extremely rugged mechanical design.

All lenses have lock screws for focus and iris adjustment and a compact design. Low distortion, high image contrast and high light transmission set di-soric Solutions lenses apart.

- Various focal lengths from 3.5 to 100mm
- Compact design
- Lock screws for focus and iris adjustment
- Option for attaching filters on all models

Selection of the right optics

For measurement and testing tasks, a video image (an image of what is shot by the sensor and "interpreted" by the camera sensor) is recorded by the software instead of the object itself.

The information, which is visible and available for evaluation on the monitor as an "image", is the result of tailored lighting, preceding filters, the choice of appropriate camera sensor, the object of inspection itself and, in large part, to the use of the correct optics.

This means that selecting an appropriate lens takes on an important role in ensuring high-quality evaluation.

Important selection criteria for the right optics

- Size of the inspection object or the object range to be detected
- Sensor size (mapping size, defined by the camera)
- Working distance between inspection object and optics (note the distance to the optical center of the systems)
- Distance from the optics to the sensor using standards defined by the camera manufacturer with a variety of mounting dimensions
- (C-mount, CS-mount)
- Type of camera sensor (pixel size = required resolving power of the optics as well as sensor-specific details such as microlenses, etc.)
- Desired optical beam input (entocentric or telecentric)
- Light intensity / lens aperture / required depth of field

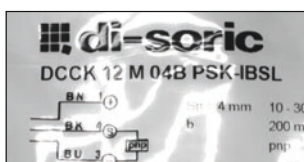

Polarization in barlight

Reflections on plastic are effectively eliminated by using polarized lighting and a polarization filter mounted on the lens.

Since a lot of light is absorbed by the polarization filter, this method requires the use of abundant amounts of light. This light can be equalized in LED lighting through the use of LED flash controllers.

The basic principle behind eliminating reflections on smooth, non-metallic surfaces such as plastic, glass and water is based on the fact that light becomes polarized upon encountering the surface of the material under a certain angle. This polarization effect is especially prominent at an exit angle of 30 to 50 degrees. Blocking this polarized light using a polarization filter can make the unpolarized background easier to see: Light reflections disappear from surfaces!

Metal sheen on metallic surfaces can be effectively eliminated through the use of a polarized light source and a polarization filter.

The metal parts appear very dark in the camera image. Uneven objects like cylindrical or arched metal surfaces and crumpled foils (aluminum blisters) are usually impossible or very difficult to light evenly.

Depending on the position of the objects being inspected, these reflections can "wander" all over the surface.

A object that has been taught starts looking very different very fast, leading to failed inspections.

Using this lighting and filter technology provides a reliable means of eliminating the failed inspections noted above.



Lenses and accessories







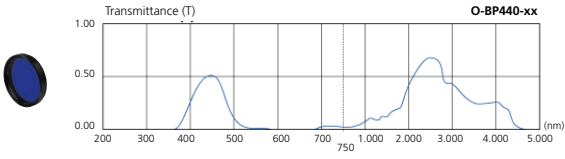
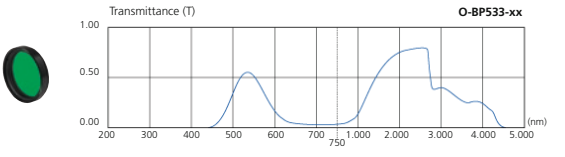
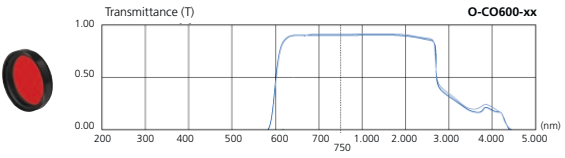

Focal length (mm)	Aperture ratio	Aperture (F)	Low distortion	High resolution	IR-optimized	- 2 MP	2 - 5 MP	5 to 9 MP	- 12 MP	Working distance WD (mm)	Minimum Object Distance MOD (mm)	Screw thread: C-mount	Mx-filter thread Pitch P (mm)	Minimum pixel size (µm)	Sensor size, max.	Weight (g)	Product designation
Lenses										Resolution							Product designation
3.5	1:1.4	1.4				■				200	200	■	-	10	1/2"	73 g	0-C1-S-035-14
6	1:1.4	1.4				■				200	200	■	M27 x 0.5	10	1/2"	49 g	0-C1-S-06-14
8	1:1.3	1.3				■				200	200	■	M25.5 x 0.5	10	2/3"	55 g	0-C1-S-08-13
12	1:1.4	1.4				■				300	300	■	M27 x 0.5	10	1/2"	44 g	0-C1-S-12-14
16	1:1.4	1.4				■				400	400	■	M27 x 0.5	10	2/3"	34 g	0-C1-S-16-14
25	1:1.4	1.4				■				500	500	■	M27 x 0.5	10	1"	36 g	0-C1-S-25-14
35	1:1.8	1.8				■				300	300	■	M27 x 0.5	10	2/3"	47 g	0-C1-S-35-18
50	1:1.8	1.8				■				1000	1000	■	M30.5 x 0.5	10	2/3"	67 g	0-C1-S-50-18
75	1:2.7	2.7				■				1000	1000	■	M30.5 x 0.5	10	1/2"	76 g	0-C1-S-75-27
100	1:3.5	3.5				■				1000	1000	■	M30.5 x 0.5	10	1/2"	79 g	0-C1-S-100-35
6	1:2.0	2.0		■			■			100	100	■	M27 x 0.5	3.3	1/1.8"	62 g	0-C2-C-06-20
8	1:1.8	1.8		■			■			100	100	■	M27 x 0.5	3.3	1/1.8"	64 g	0-C2-C-08-18
12	1:1.8	1.8		■			■			100	100	■	M27 x 0.5	3.3	1/1.8"	60 g	0-C2-C-12-18
16	1:1.8	1.8		■			■			100	100	■	M27 x 0.5	3.3	1/1.8"	58 g	0-C2-C-16-18
25	1:1.8	1.8		■			■			250	250	■	M27 x 0.5	3.3	1/1.8"	60 g	0-C2-C-25-18
35	1:1.8	1.8		■			■			250	250	■	M27 x 0.5	3.3	2/3"	48 g	0-C2-C-35-18
50	1:2.6	2.6		■			■			400	400	■	M27 x 0.5	3.3	2/3"	54 g	0-C2-C-50-26

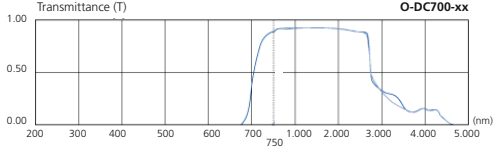
Focal length (mm)	Aperture ratio	Aperture (F)	Low distortion	High resolution	IR-optimized	~ 2 MP	2 ~ 5 MP	5 to 9 MP	~ 12 MP	Working distance WD (mm)	Minimum Object Distance MOD (mm)	Screw thread: C-mount	Mx-filter thread Pitch P (mm)	Minimum pixel size (µm)	Sensor size, max.	Weight (g)	Product designation
Lenses			Resolution												Product designation		
4	1:2.0	2.1	■			■				403.2–92.7		■	M27 x 0.5	7	1/2"	76 g	0-C2-LDA-04-21
15	1:2.0	2.1 - 2.2	■			■				489.2–88.9		■	M27 x 0.5	7	2/3"	46 g	0-C2-LDA-15-21
20	1:2.0	2.1 - 2.3	■			■				510.3–86.6		■	M27 x 0.5	7	2/3"	47 g	0-C2-LDA-20-21
25	1:2.0	2.1 - 2.6	■			■				508.2–100.2		■	M27 x 0.5	7	2/3"	49 g	0-C2-LDA-25-21
30	1:2.0	2.4 - 2.8	■			■				381.6–141.5		■	M27 x 0.5	7	2/3"	47 g	0-C2-LDA-30-24
35	1:1.9	2.5 - 2.9	■			■				142.9–96.1		■	M27 x 0.5	7	2/3"	58 g	0-C2-LDA-35-25
50	1:2.5	2.7 - 3.1	■			■				512.4–221.5		■	M27 x 0.5	7	2/3"	76 g	0-C2-LDA-50-27
75	1:3.8	4.1 - 4.5	■			■				527.5–245.6		■	M27 x 0.5	7	2/3"	92 g	0-C2-LDA-75-41
6	1:1.4	1.4		■		■				100	100	■	M40.5 x 0.5	3.45	2/3"	145 g	0-C2-S-06-14
8	1:1.4	1.4		■		■				100	100	■	M35.5 x 0.5	3.45	2/3"	125 g	0-C2-S-08-14
100	1:2.8	2.8		■		■				2000	2000	■	M37.5 x 0.5	3.45	1"	105 g	0-C2-S-100-28
12	1:1.4	1.4		■		■				100	100	■	M27 x 0.5	3.45	2/3"	85 g	0-C2-S-12-14
16	1:1.4	1.4		■		■				100	100	■	M27 x 0.5	3.45	2/3"	85 g	0-C2-S-16-14
25	1:1.4	1.4		■		■				150	150	■	M27 x 0.5	3.45	2/3"	65 g	0-C2-S-25-14
50	1:2.6	2.6		■		■				500	500	■	M27 x 0.5	3.45	2/3"	53 g	0-C2-S-50-26
75	1:2.5	2.5		■		■				1200	1200	■	M34 x 0.5	3.45	1"	85 g	0-C2-S-75-25
35	1:1.4	1.4		■		■				200	200	■	M35.5 x 0.5	3.45	2/3"	150 g	0-C3-S-35-14
50	1:1.4	1.4		■		■				300	300	■	M40.5 x 0.5	3.45	2/3"	170 g	0-C3-S-50-14
6	1:1.8	1.8		■			■				100	■	-	5	1"	250g	0-C4-S-06-18
8	1:1.4	1.4		■			■				100	■	M55 x 0.75	5	1"	200g	0-C4-S-08-14
12	1:1.4	1.4		■			■			300	300	■	M35.5 x 0.5	5	1"	140 g	0-C4-S-12-14
16	1:1.4	1.4		■			■			300	300	■	M30.5 x 0.5	5	1"	140 g	0-C4-S-16-14
25	1:1.4	1.4		■			■			300	300	■	M30.5 x 0.5	5	1"	90 g	0-C4-S-25-14
35	1:1.4	1.4		■			■			300	300	■	M30.5 x 0.5	5	1"	100 g	0-C4-S-35-14
50	1:1.8	1.8		■			■			500	500	■	M40.5 x 0.5	5	1"	135 g	0-C4-S-50-18
12	1:1.8	1.8		■			■				300	■	M52 x 0.75	3.45	1.1"	340 g	0-C5-S-12-18/IRO
16	1:1.8	1.8		■			■				300	■	M40 x 0.5	3.45	1.1"	290 g	0-C5-S-16-18/IRO
25	1:1.8	1.8		■			■				300	■	M43 x 0.75	3.45	1.1"	390 g	0-C5-S-25-18/IRO

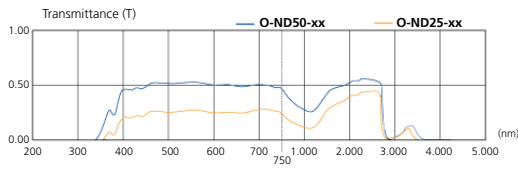
Lenses and accessories

		Magnification factor	Spacer distance (mm)	Wavelength	Transmission	Material Filter thread: Filter:	Aluminum Glass	Mounting thread for additional filters	Filter thread M x pitch P (mm)	Product description	
Converter											
		1.5						M25.5 x 0.5	0-1.5X		
		2.0						M27 x 0.5	0-2.0X		
		2.5						M30.5 x 0.5	0-2.5X		
Spacer rings											
		0.5								0-ER-005	
		1.0								0-ER-010	
		5.0									0-ER-050
		10.0									0-ER-100
		20.0									0-ER-200
		Set									0-ET-5
Bandpass filter											
 <p>O-BP440-xx</p>				440 nm Blue		■		M25.5 x 0.5	0-BP440-25		
								M27 x 0.5	0-BP440-27		
								M30.5 x 0.5	0-BP440-30		
								M35.5 x 0.5	0-BP440-35		
								M40.5 x 0.5	0-BP440-40		
 <p>O-BP533-xx</p>				533 nm Green		■		M25.5 x 0.5	0-BP533-25		
								M27 x 0.5	0-BP533-27		
								M30.5 x 0.5	0-BP533-30		
								M35.5 x 0.5	0-BP533-35		
								M40.5 x 0.5	0-BP533-40		
Cutoff filter											
 <p>O-CO600-xx</p>				>600 nm Red		■		M25.5 x 0.5	0-CO600-25		
								M27 x 0.5	0-CO600-27		
								M30.5 x 0.5	0-CO600-30		
								M35.5 x 0.5	0-CO600-35		
								M40.5 x 0.5	0-CO600-40		

		Magnification factor	Spacer distance (mm)	Wavelength	Transmission	Material Filter thread: Filter:	Aluminum Glass	Mounting thread for additional filters	Filter thread Mxpitch P (mm)	
Daylight cutoff filter										Product description
 				>700nm		■		M25.5 x 0.5	0-DC700-25	
								M27 x 0.5	0-DC700-27	
								M30.5 x 0.5	0-DC700-30	
								M35.5 x 0.5	0-DC700-35	
								M40.5 x 0.5	0-DC700-40	
Neutral density filter										
  				25%		■	■	M25.5 x 0.5	0-ND25-25	
								M27 x 0.5	0-ND25-27	
								M30.5 x 0.5	0-ND25-30	
								M35.5 x 0.5	0-ND25-35	
								M40.5 x 0.5	0-ND25-40	
					50%		■	■	M25.5 x 0.5	0-ND50-25
								M27 x 0.5	0-ND50-27	
								M30.5 x 0.5	0-ND50-30	
								M35.5 x 0.5	0-ND50-35	
								M40.5 x 0.5	0-ND50-40	
Polarization filter with lock screw										
							■	■	M25.5 x 0.5	0-POL-25
								M27 x 0.5	0-POL-27	
								M30.5 x 0.5	0-POL-30	
								M35.5 x 0.5	0-POL-35	
								M40.5 x 0.5	0-POL-40	
Lens protection glass										
							■		M25.5 x 0.5	0-PG-25
								M27 x 0.5	0-PG-27	
								M30.5 x 0.5	0-PG-30	
								M35.5 x 0.5	0-PG-35	
								M40.5 x 0.5	0-PG-40	

Safety light curtains / grids provide the perfect solution for virtually any tasks relating to machine safety. A wide variety of functions and sizes provide optimal versatility for applications.

Safety light curtains / grids

- Compact design
- No shielded cables required
- Easy and fast startup
- No blind zone at the end of the profile
- Integrated safety functions
- Two static pnp safety outputs
- Master/slave models
- Models in IP 69K and heated protective housing

Modular safety systems

- Compact design
- Removable terminal blocks
- Easy-to-use, intuitive "MS-Safety Designer" software
- Many configurable safety functions and logic operators
- Removable memory card
- High-speed bus
- 14 expansion units
- 128 inputs and 16 OSSD safety outputs



Safety and interface relay

- Extensive usability
- Relay with integrated muting function
- Additional safety functions such as
 - Start / Restart interlock
 - Feedback input for EDM
- LED indicators for status, muting and diagnostics



Safety-related accessories

- Connection cables and plug connectors
- Installation systems and deflection mirrors
- Vibration dampers
- Laser alignment device
- And much more

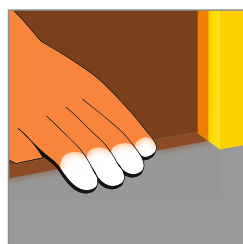
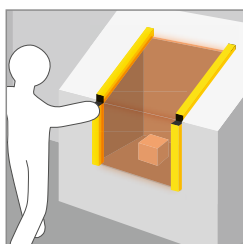
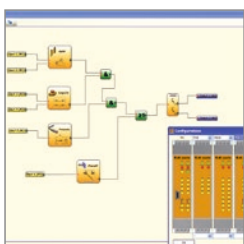
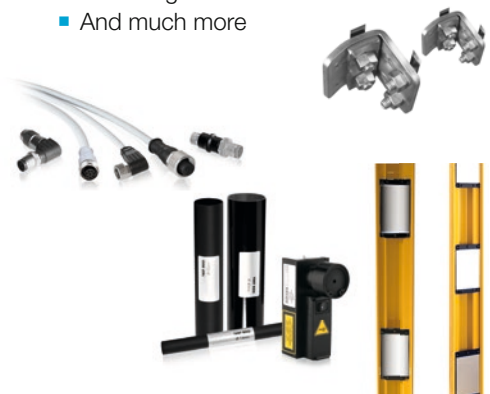

PLr risk graph

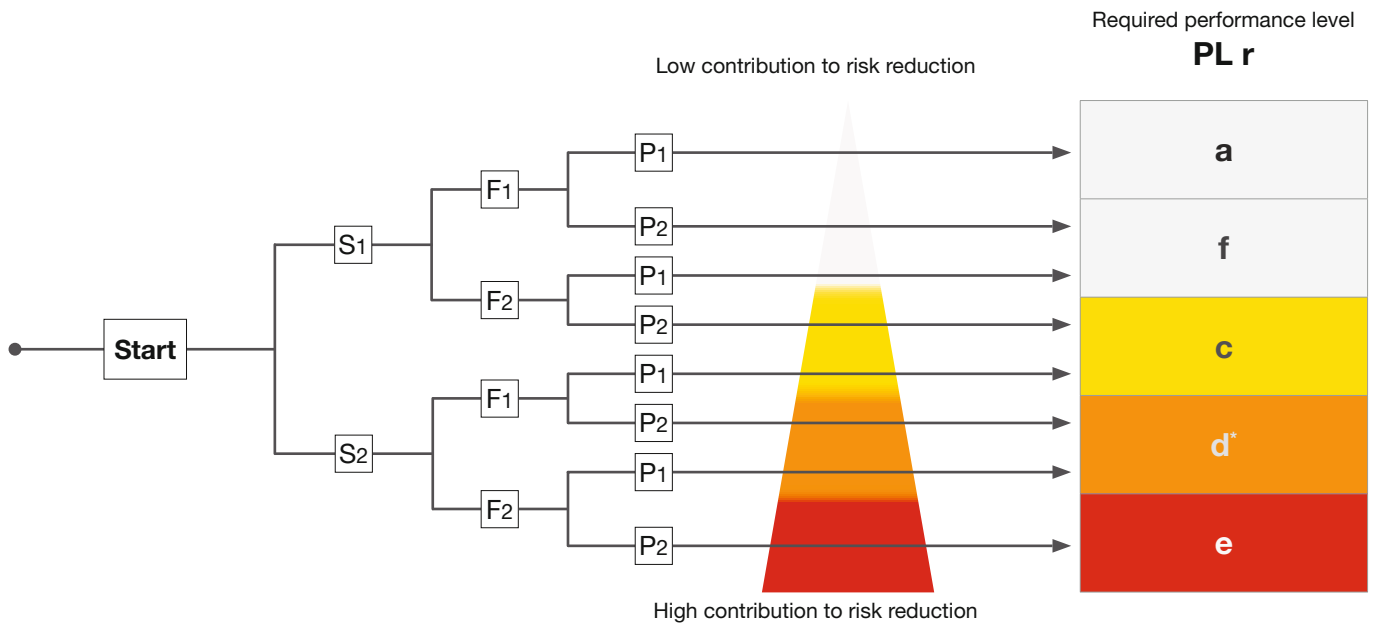

T	Injury severity level
S1	Minor injury (usually reversible)
S2	Serious injury (usually irreversible) or death
F	Frequency and/or duration of the exposure to the hazard
F1	Seldom/short
F2	Continuous/prolonged
P	Possibility of preventing the hazard or limiting the harm
P1	Possible under certain conditions
P2	Virtually impossible



Note: The PLr values are entirely "hierarchical". PLr(e) provides the largest and PLr(a) provides the smallest amount for risk reduction.

* If a required performance level of PL **d** is necessary, light curtains with a **Type 4** safety level must be used!

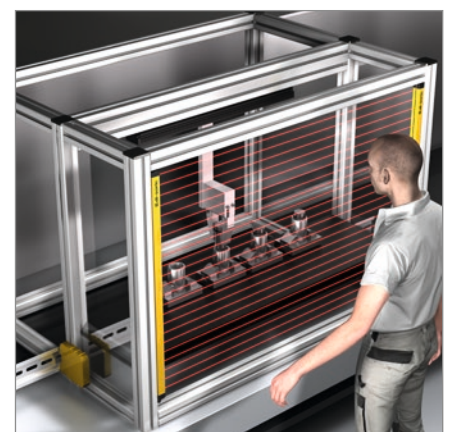
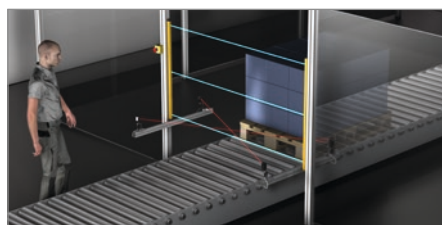
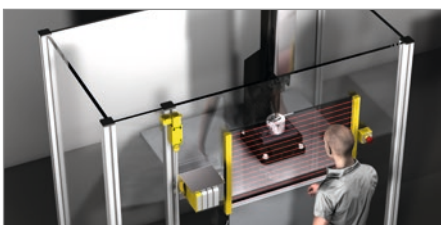

Directives and standards for PL e

safety light curtains / grids and safety relays

Typ 4 / Type 4 in accordance with IEC/TS 61496-2
SIL 3 – SILCL 3 in accordance with IEC 61508 - IEC 62061

PL e – Cat. 4 in accordance with ISO 13849-1

Safety level

TYPE 4
SIL 3 – SILCL 3
PL e – Cat. 4

Corresponds to the following directives and standards:

- 2006/42/EC "Machinery Directive"
- 2014/30/EU "EMC Directive / Directive relating to electromagnetic compatibility"
- 2014/35/EU "Low Voltage Directive"
- 2011/65/EU "RoHS Directive"
- IEC/EN 61496-1 Edition 2.1, IEC/TS 61496-2 Edition 2 "Electro-sensitive protective equipment"
- EN ISO 13849-1 "Safety of machinery - Safety-related parts of control systems - Part 1: General principles for design"
- IEC/EN 62061 ed. 1; am1 "Safety of machinery – Functional safety of safety-related electrical, electronic and programmable electronic control systems"
- IEC 61508-1, -2, -3, -4 ed. 2 "Functional safety of safety-related electrical, electronic and programmable electronic control systems"
- EN 50178: 1997 "Electronic equipment for use in power installations"
- EN 55022: 2010 "Information technology equipment – Radio disturbance characteristics – Limits and methods of measurement"
- EN 61000-6-2: 2005 "Electromagnetic compatibility (EMC) - Part 6-2: Generic standards – Immunity for industrial environments"
- UL (C+US) for Canada and the USA
- ANSI / UL 1998 "Safety software in programmable components".



MODSI - Modular safety system

Typ 4 / Type 4 in accordance with IEC/TS 61496-2
SIL 3 – SILCL 3 in accordance with IEC 61508 - IEC 62061

PL e – Cat. 4 in accordance with ISO 13849-1

Safety level

TYPE 4
SIL 3 – SILCL 3
PL e – Cat. 4

Corresponds to the following directives and standards:

- 2006/42/EC "Machinery Directive"
- 2014/30/EU "EMC Directive / Directive relating to electromagnetic compatibility"
- 2014/35/EU "Low Voltage Directive"
- CEI EN 61131-2 "Programmable controllers, Part 2: Equipment requirements and tests"
- EN ISO 13849-1 "Safety of machinery - Safety-related parts of control systems - Part 1: General principles for design"
- EN ISO 13849-2 "Safety of machinery: Safety-related parts of control systems - Part 2: Validation"
- IEC/EN 61496-1 "Safety of machinery: Electro-sensitive protective equipment - Part 1: General requirements and tests"
- IEC/EN 62061 "Safety of machinery – Functional safety of safety-related electrical, electronic and programmable electronic control systems"
- IEC 61508-1 "Functional safety of safety-related electrical, electronic and programmable electronic control systems - Part 1: General requirements"
- IEC 61508-2 "Functional safety of safety-related electrical, electronic and programmable electronic control systems - Part 2: Requirements for electrical/electronic/programmable electronic safety-related systems"
- IEC 61508-3 "Functional safety of safety-related electrical, electronic and programmable electronic control systems - Part 3: Software requirements"
- IEC 61508-4 "Functional safety of electrical/electronic/programmable electronic safety-related systems - Part 4: Definitions and abbreviations"
- IEC 61784-3 "Industrial communication networks - Profiles - Part 3: Functional safety fieldbuses - General rules and profile definitions"
- UL (C+US) for Canada and the USA
- ANSI / UL 1998 "Safety software in programmable components".



Selection guide for safety light curtains / grids

It is helpful to divide the application of safety light curtains / grids into four groups:

	Detection of a finger		Detection of a body in the danger zone
	Detection of a hand		Detection of a body during the access control



Finger protection	SLB4-...	SLI4-...
Light barrier type	Light curtain	
Safety level	Type 4 SIL 3 – SILCL 3 PL e – Cat. 4	
Resolution	14 mm	
Protective field height	160 - 1,810 mm	
Maximum operating distance	6 m	
Start / restart interlock integrated	-	✓
EDM integrated	-	✓
Master/slave versions	-	✓ (Slave / Slave 2)



Hand protection	SLB4-...	SLBH4-...	SLI4-...	SLIH4-...
Light barrier type	Light curtain			
Safety level	Type 4 SIL 3 – SILCL 3 PL e – Cat. 4			
Resolution	20 - 30 - 40 mm			
Protective field height	160 - 1,810 mm			
Maximum operating distance	12 m	20 m	12 m	20 m
Start / restart interlock integrated	-	-	✓	✓
EDM integrated	-	-	✓	✓
Master/slave versions	-	-	✓ (Slave / Slave 2)	-



Body protection	SLB4-...	SLBH4-...	SLI4-...	SLIH4-...
Light barrier type	Light curtain			
Safety level	Type 4 SIL 3 – SILCL 3 PL e – Cat. 4			
Resolution	50 - 90 mm			
Protective field height	160 - 1,810 mm			
Maximum operating distance	12 m	20 m	12 m	20 m
Start / restart interlock integrated	-	-	✓	✓
EDM integrated	-	-	✓	✓
Master/slave versions	-	-	✓ (Slave / Slave 2)	-



Access control	SLB4-xB	SLBH4-xB	SLI4-xB	SLIH4-xB
Light barrier type	Light grids			
Safety level	Type 4 SIL 3 – SILCL 3 PL e – Cat. 4			
Number of beams	2 - 3 - 4			
Beam separation (axis distance)	300 - 400 - 500 mm			
Protective field height	510 - 810 - 910 mm			
Maximum operating distance	12 m	20 m	12 m	20 m
Start / restart interlock integrated	-	-	✓	✓
EDM integrated	-	-	✓	✓
Master/slave versions	-	-	✓ (Slave / Slave 2)	-

Glossary

Start / restart interlock:

Locking function when the machine is started or restarted (manual confirmation required).

EDM - External Device Monitoring:

Monitoring of the external switch protection devices using a feedback input.

Master/slave:

Two or three light curtains/grids can be switched in series; all outputs are managed by only one light curtain/grid (Master).



- **SLB... and SLI...**
- Highest safety level
- Light curtains for finger protection, hand protection, body protection and presence check
- Light grid with 2, 3 or 4 beams for detecting a body during access control
- Models with an increased operating distance for large systems and applications with deflecting mirrors
- Protective field heights from 160 to 1,810 mm
- Protection area up to the profile length end of the light curtain/grid
- Configuring the operating distance via the connection cable
- Unshielded connection cables with a length of up to 100 meters are possible
- High protection type
- **Only SLI...**
- Integrated safety function – no external safety relay required
- Selectable manual or automatic Start/Restart
- Feedback input for external relay monitoring (EDM)

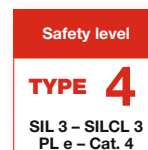



Technical data (typ.)



Safety level	Type 4 in accordance with IEC/TS 61496-2 SIL 3 – SILCL 3 in accordance with IEC 61508 - IEC 62061 PL e – Cat. 4 in accordance with ISO 13849-1
Profile cross section	28x30 mm
Safety outputs (master)	PNP (2x), 400 mA, 24 V DC
LED displays	Self-diagnostics Status
Start / restart (master)	Automatic
Service voltage	19.2 to 28.8V DC
Master connection	M12, 5-pin M12, 8-pin (receiver) (SLB... and SLI...)
Length of connection cable	max. 100m unshielded
Ambient temperature	-20 to +55 °C
Protection type	IP 65 + IP 67
Protection class	III, operation on protective low voltage
Housing material	Aluminum
Window material	Polycarbonate
Mounting	Rear side, T-shaped slot, or using adjustable brackets SFB E180 (optional)

						Product description				
						SLB4	SLBH4	SLI4	SLIH4	
Safety light curtain / grid						SLB4	SLBH4	SLI4	SLIH4	
Safety level						Type 4	Type 4	Type 4	Type 4	
Particularity						For external safety functions		Integrated safety functions		
Operating distance						up to 6 m		up to 6 m		
Finger protection 14 mm	Resolution / beam separation (mm)	15	160	213	4	Transmitter CD... Receiver CD... / SLI... : C8D	SLB4-151		SLI4-151 ¹⁾	
	Number of beams	30	310	363	5.5		SLB4-301		SLI4-301 ¹⁾	
	Protective field height (mm)	45	460	513	7.5		SLB4-451		SLI4-451 ¹⁾	
	Total height (mm)	60	610	663	9		SLB4-601		SLI4-601 ¹⁾	
	Response time (ms)	75	760	813	11		SLB4-751		SLI4-751 ¹⁾	
	Connection cable (optionally available)	90	910	963	13		SLB4-901		SLI4-901 ¹⁾	
		105	1060	1113	14.5		SLB4-1051		SLI4-1051 ¹⁾	
		120	1210	1263	16.5		SLB4-1201		SLI4-1201 ¹⁾	
		135	1360	1413	18		SLB4-1351		SLI4-1351 ¹⁾	
		150	1510	1563	20		SLB4-1501		SLI4-1501 ¹⁾	
		165	1660	1713	22		SLB4-1651		SLI4-1651 ¹⁾	
	180	1810	1886	23.5	SLB4-1801		SLI4-1801 ¹⁾			



¹⁾ See the note on page 181

						Product description				
						SLB4	SLBH4	SLI4	SLIH4	
Safety light curtain / grid						Type 4	Type 4	Type 4	Type 4	
Safety level						Type 4	Type 4	Type 4	Type 4	
Particularity						For external safety functions		Integrated safety functions		
Operating distance							up to 20 m	up to 12 m	up to 20 m	
 Hand protection 20mm	Resolution / beam separation (mm)	Number of beams	Protective field height (mm)	Total height (mm)	Response time (ms)	Transmitter CD... Receiver CD... / C8D		SLBH4-152		SLIH4-152
	30	310	363	5.5			SLBH4-302		SLIH4-302	
	45	460	513	7.5			SLBH4-452		SLIH4-452	
	60	610	663	9			SLBH4-602		SLIH4-602	
	75	760	813	11			SLBH4-752		SLIH4-752	
	90	910	963	13			SLBH4-902		SLIH4-902	
	105	1060	1113	14.5			SLBH4-1052		SLIH4-1052	
	120	1210	1263	16.5			SLBH4-1202		SLIH4-1202	
	135	1360	1413	18			SLBH4-1352		SLIH4-1352	
	150	1510	1563	20			SLBH4-1502		SLIH4-1502	
	165	1660	1713	22			SLBH4-1652		SLIH4-1652	
180	1810	1886	23.5		SLBH4-1802		SLIH4-1802			
Operating distance						up to 12 m	up to 20 m	up to 12 m	up to 20 m	
 Hand protection 30mm	Resolution / beam separation (mm)	Number of beams	Protective field height (mm)	Total height (mm)	Response time (ms)	Transmitter CD... Receiver CD... / C8D	SLB4-153		SLI4-153 ¹⁾	
	13	260	313	5			SLB4-253		SLI4-253 ¹⁾	
	16	310	363	5.4			SLB4-303		SLI4-303 ¹⁾	
	23	460	513	7.5			SLB4-453		SLI4-453 ¹⁾	
	31	610	663	9			SLB4-603		SLI4-603 ¹⁾	
	38	760	813	10.5			SLB4-753		SLI4-753 ¹⁾	
	46	910	963	12.5			SLB4-903		SLI4-903 ¹⁾	
	53	1060	1113	14			SLB4-1053		SLI4-1053 ¹⁾	
	61	1210	1263	15.5			SLB4-1203		SLI4-1203 ¹⁾	
	68	1360	1413	17			SLB4-1353		SLI4-1353 ¹⁾	
	76	1510	1563	19			SLB4-1503		SLI4-1503 ¹⁾	
	88	1660	1713	20.5			SLB4-1653		SLI4-1653 ¹⁾	
	91	1810	1886	22			SLB4-1803		SLI4-1803 ¹⁾	
Operating distance						up to 12 m	up to 20 m	up to 12 m	up to 20 m	
 Hand protection 30mm	Resolution / beam separation (mm)	Number of beams	Protective field height (mm)	Total height (mm)	Response time (ms)	Transmitter CD... Receiver CD... / C8D		SLBH4-153		SLIH4-153 ¹⁾
	16	310	363	4			SLBH4-303		SLIH4-303 ¹⁾	
	23	460	513	5			SLBH4-453		SLIH4-453 ¹⁾	
	31	610	663	6			SLBH4-603		SLIH4-603 ¹⁾	
	38	760	813	6.5			SLBH4-753		SLIH4-753 ¹⁾	
	46	910	963	7.5			SLBH4-903		SLIH4-903 ¹⁾	
	53	1060	1113	8.5			SLBH4-1053		SLIH4-1053 ¹⁾	
	61	1210	1263	9.5			SLBH4-1203		SLIH4-1203 ¹⁾	
	68	1360	1413	10			SLBH4-1353		SLIH4-1353 ¹⁾	
	76	1510	1563	11			SLBH4-1503		SLIH4-1503 ¹⁾	
	88	1660	1713	12			SLBH4-1653		SLIH4-1653 ¹⁾	
91	1810	1886	13		SLBH4-1803		SLIH4-1803 ¹⁾			



¹⁾See the note on page 181

						Product description				
						SLB4	SLBH4	SLI4	SLIH4	
Safety light curtain / grid						Type 4	Type 4	Type 4	Type 4	
Safety level						Type 4	Type 4	Type 4	Type 4	
Particularity						For external safety functions		Integrated safety functions		
Operating distance						up to 12 m	up to 20 m	up to 12 m	up to 20 m	
 Hand protection 40mm	6	160	213	3.5	Transmitter CD... Receiver CD... / C8D	SLB4-154		SLI4-154 ¹⁾		
	8	260	313	4		SLB4-254		SLI4-254 ¹⁾		
	11	310	363	4.5		SLB4-304		SLI4-304 ¹⁾		
	16	460	513	5.5		SLB4-454		SLI4-454 ¹⁾		
	21	610	663	7		SLB4-604		SLI4-604 ¹⁾		
	26	760	813	8		SLB4-754		SLI4-754 ¹⁾		
	31	910	963	9		SLB4-904		SLI4-904 ¹⁾		
	36	1060	1113	10		SLB4-1054		SLI4-1054 ¹⁾		
	41	1210	1263	11		SLB4-1204		SLI4-1204 ¹⁾		
	46	1360	1413	12.5		SLB4-1354		SLI4-1354 ¹⁾		
	51	1510	1563	13.5		SLB4-1504		SLI4-1504 ¹⁾		
	56	1660	1713	14.5		SLB4-1654		SLI4-1654 ¹⁾		
	61	1810	1886	15.5		SLB4-1804		SLI4-1804 ¹⁾		
Operating distance						up to 12 m	up to 20 m	up to 12 m	up to 20 m	
 Hand protection 40mm	6	160	213	3	Transmitter CD... Receiver CD... / C8D		SLBH4-154		SLIH4-154 ¹⁾	
	8	260	313							
	11	310	363	3.5			SLBH4-304		SLIH4-304 ¹⁾	
	16	460	513	4			SLBH4-454		SLIH4-454 ¹⁾	
	21	610	663	4.5			SLBH4-604		SLIH4-604 ¹⁾	
	26	760	813	5			SLBH4-754		SLIH4-754 ¹⁾	
	31	910	963	6			SLBH4-904		SLIH4-904 ¹⁾	
	36	1060	1113	6.5			SLBH4-1054		SLIH4-1054 ¹⁾	
	41	1210	1263	7			SLBH4-1204		SLIH4-1204 ¹⁾	
	46	1360	1413	7.5			SLBH4-1354		SLIH4-1354 ¹⁾	
	51	1510	1563	8			SLBH4-1504		SLIH4-1504 ¹⁾	
	56	1660	1713	8.5			SLBH4-1654		SLIH4-1654 ¹⁾	
	61	1810	1886	9.5			SLBH4-1804		SLIH4-1804 ¹⁾	

¹⁾See the note on page 181

						Product description			
						SLB4	SLBH4	SLI4	SLIH4
Safety light curtain / grid						Type 4	Type 4	Type 4	Type 4
Safety level						Type 4	Type 4	Type 4	Type 4
Particularity						For external safety functions		Integrated safety functions	
Operating distance						up to 12 m	up to 20 m	up to 12 m	up to 20 m
 Hand protection 50mm	4	160	213	3	Transmitter CD... Receiver CD... / C8D	SLB4-155		SLI4-155 ¹⁾	
	8	310	363	4		SLB4-305		SLI4-305 ¹⁾	
	12	460	513	4.5		SLB4-455		SLI4-455 ¹⁾	
	16	610	663	5.5		SLB4-605		SLI4-605 ¹⁾	
	20	760	813	6.5		SLB4-755		SLI4-755 ¹⁾	
	24	910	963	7.5		SLB4-905		SLI4-905 ¹⁾	
	28	1060	1113	8.5		SLB4-1055		SLI4-1055 ¹⁾	
	32	1210	1263	9		SLB4-1205		SLI4-1205 ¹⁾	
	36	1360	1413	10		SLB4-1355		SLI4-1355 ¹⁾	
	40	1510	1563	11		SLB4-1505		SLI4-1505 ¹⁾	
	44	1660	1713	12		SLB4-1655		SLI4-1655 ¹⁾	
48	1810	1886	13	SLB4-1805		SLI4-1805 ¹⁾			
Operating distance						up to 12 m	up to 20 m	up to 12 m	up to 20 m
 Hand protection 50mm	4	160	213	2.5	Transmitter CD... Receiver CD... / C8D		SLBH4-155		SLIH4-155 ¹⁾
	8	310	363	3			SLBH4-305		SLIH4-305 ¹⁾
	12	460	513	3.5			SLBH4-455		SLIH4-455 ¹⁾
	16	610	663	4			SLBH4-605		SLIH4-605 ¹⁾
	20	760	813	4.5			SLBH4-755		SLIH4-755 ¹⁾
	24	910	963	5			SLBH4-905		SLIH4-905 ¹⁾
	28	1060	1113	5.5			SLBH4-1055		SLIH4-1055 ¹⁾
	32	1210	1263	6			SLBH4-1205		SLIH4-1205 ¹⁾
	36	1360	1413	6.5			SLBH4-1355		SLIH4-1355 ¹⁾
	40	1510	1563	7			SLBH4-1505		SLIH4-1505 ¹⁾
	44	1660	1713	7			SLBH4-1655		SLIH4-1655 ¹⁾
48	1810	1886	8		SLBH4-1805		SLIH4-1805 ¹⁾		
Operating distance						up to 12 m	up to 20 m	up to 12 m	up to 20 m
 Body protection 90mm	4	310	363	3	Transmitter CD... Receiver CD... / C8D	SLB4-309		SLI4-309 ¹⁾	
	6	460	513	3.5		SLB4-459		SLI4-459 ¹⁾	
	8	610	663	4		SLB4-609		SLI4-609 ¹⁾	
	10	760	813	4.5		SLB4-759		SLI4-759 ¹⁾	
	12	910	963	5		SLB4-909		SLI4-909 ¹⁾	
	14	1060	1113	5.5		SLB4-1059		SLI4-1059 ¹⁾	
	16	1210	1263	5.5		SLB4-1209		SLI4-1209 ¹⁾	
	18	1360	1413	6		SLB4-1359		SLI4-1359 ¹⁾	
	20	1510	1563	6.5		SLB4-1509		SLI4-1509 ¹⁾	
	22	1660	1713	7		SLB4-1659		SLI4-1659 ¹⁾	
	24	1810	1886	7.5		SLB4-1809		SLI4-1809 ¹⁾	

¹⁾ See the note on page 181

							Product description			
							SLB4	SLBH4	SLI4	SLIH4
Safety light curtain / grid							Type 4	Type 4	Type 4	Type 4
Safety level							Type 4	Type 4	Type 4	Type 4
Particularity							For external safety functions		Integrated safety functions	
Operating distance							up to 12 m	up to 20 m	up to 12 m	up to 20 m
 Body protection 90mm	4	310	363	2.5	Transmitter CD ... Receiver CD... / C8D		SLBH4-309		SLIH4-309 ¹⁾	
	6	460	513	3			SLBH4-459		SLIH4-459 ¹⁾	
	8	610	663	3			SLBH4-609		SLIH4-609 ¹⁾	
	10	760	813	3.5			SLBH4-759		SLIH4-759 ¹⁾	
	12	910	963	3.5			SLBH4-909		SLIH4-909 ¹⁾	
	14	1060	1113	3.5			SLBH4-1059		SLIH4-1059 ¹⁾	
	16	1210	1263	4			SLBH4-1209		SLIH4-1209 ¹⁾	
	18	1360	1413	4			SLBH4-1359		SLIH4-1359 ¹⁾	
	20	1510	1563	4.5			SLBH4-1509		SLIH4-1509 ¹⁾	
	22	1660	1713	4.5			SLBH4-1659		SLIH4-1659 ¹⁾	
24	1810	1886	5		SLBH4-1809		SLIH4-1809 ¹⁾			
Operating distance							up to 12 m	up to 20 m	up to 12 m	up to 20 m
	500	2	510	653	2.5	Transmitter CD ... Receiver CD... / SLI... : C8D	SLB4-2B		SLI4-2B ¹⁾	
	400	3	810	953	3		SLB4-3B		SLI4-3B ¹⁾	
	300	4	910	1053	3		SLB4-4B		SLI4-4B ¹⁾	
	500	2	510	653	2.5	Transmitter CD ... Receiver CD... / SLI... : C8D		SLBH4-2B	SLIH4-2B ¹⁾	
	400	3	810	953	2.5			SLBH4-3B	SLIH4-3B ¹⁾	
	300	4	910	1053	2.5			SLBH4-4B	SLIH4-4B ¹⁾	

Note

¹⁾ Light curtains/grids are also available as a variant in a protective housing.

SLI... -WTF (IP 69K)

SLI... -WTHF (IP 69K, heated)

Safety light curtains / grids type 4- master/slave models, with integrated monitoring functions



- Combination of different resolutions and protective field heights
- Up to three monitoring ranges
- Only one safety module / two relays required for evaluation
- Simplified cabling via series connection
- Highest safety level
- Light curtains for finger protection, hand protection, body protection and presence check
- Light grid with 2, 3 or 4 beams for detecting a body during access control
- Protective field heights from 160 to 1,810 mm
- Unshielded connection cables
- Master connection cable up to 100 m – Master/Slave connection cable up to 50 m
- Selectable manual or automatic Start/Restart
- Feedback input for external relay monitoring (EDM)
- High protection type

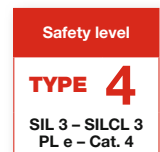

Formulas for calculating the total response time in the case of master/slave series connections SLI4-...:

For a resolution of 14 mm	Master + Slave	$t_{tot} = [0.06 \times (No_{Master} + No_{Slave}) + 0.9636] \times 2$
	Master + Slave 2 + Slave	$t_{tot} = [0.06 \times (No_{Master} + No_{Slave 2} + No_{Slave}) + 1.0036] \times 2$
For all other resolutions or beam separations	Master + Slave	$t_{tot} = [0.11 \times (No_{Master} + No_{Slave}) + 0.9376] \times 2$
	Master + Slave 2 + Slave	$t_{tot} = [0.11 \times (No_{Master} + No_{Slave 2} + No_{Slave}) + 1.0508] \times 2$
Key	t_{tot} = Total response time	No. = Number of beams for the selected model

Function of master/slave models

The master/slave model makes it possible to switch up to three light curtains/grids in series and to have combined detection of hands and body, or to simultaneously monitor various sides of the machine. With the following critical advantages:

- ◆ Only one pair of safety outputs
- ◆ No interference between light barriers installed in adjacent spaces

Examples for series connection of master/slave models

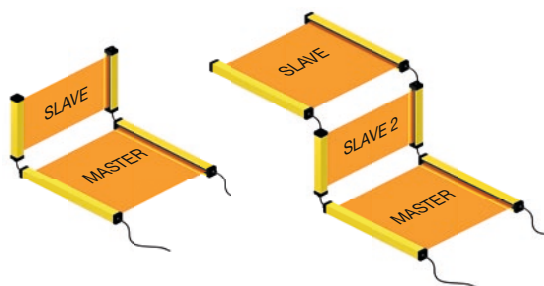

It is possible to connect each master model to any slave model. All electrical connections are made with 5-pin M12 connectors, with the exception of the master receiver, which requires an 8-pin M12 connector. For the connection between master and slave, cables prefabricated with 2 connectors are available (see page 186).

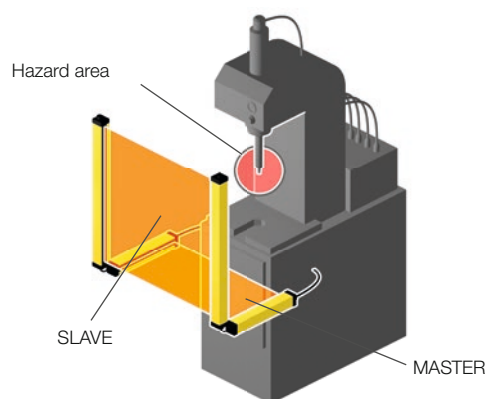

The master is positioned horizontally for detecting a body, while the vertical slave takes over detecting hands.

You can also turn the connection and position the master vertically for protecting hands and the slave horizontally for detecting a body.

The application pictured here is among the most common: Horizontal safety light curtains / grids are used for preventing the operator from going undetected if he or she remains between the vertical light curtain/grid and the dangerous machine when turning it on or restarting it.

Example of series connection of master/slave models for protecting two sides of a machine

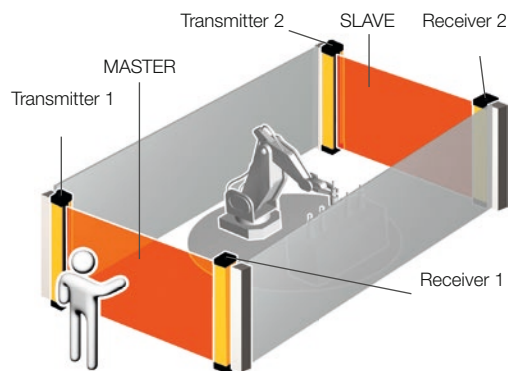

In the case of safety light curtains / grids SLI, a (non-shielded) standard cable is used for the connection between master and slave. It can have a length of up to 50 meters (see page 186).

This property allows for the use of 2 light curtains / grids switched in series, whereby one of them is positioned on the front side and the other on the rear side of the machine; in the event of only one connection for the power supply and the control circuit of the machine.

Up to 3 safety light curtains / grids switched in series are possible.

Advantage when using master/slave series connections

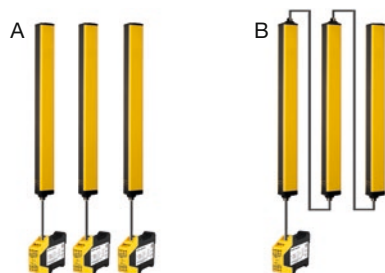







Schematic of the series connection

- A For three standard light curtains/grids, 3 safety modules or 6 relays have to be used and cabled.
- B For the master/slave solution with 3 light curtains/grids switched in series, it is possible to use and cable only 1 safety module or 2 relays.

Safety light curtains / grids type 4- master/slave models, with integrated monitoring functions

Technical data (typ.)	
Safety level	Type 4 in accordance with IEC/TS 61496-2 SIL 3 – SILCL 3 in accordance with IEC 61508 - IEC 62061 PL e – Cat. 4 in accordance with ISO 13849-1
Profile cross section	28x30 mm
Safety outputs (master)	PNP (2x), 400mA, 24 V DC
LED displays	Self-diagnostics Status
Start / restart (master)	Automatic or manual (selectable)
External relay (device) monitoring - EDM (master models)	Feedback input, selectable release
Service voltage	19.2 to 28.8V DC
Master connection	M12, 5-pin (transmitter) M12, 8-pin (receiver)
Master / slave 2 / slave connection	M12, 5-pin (transmitter and receiver)
Length of connection cable	max. 100m unshielded
Length of connection cable	max. 50m unshielded (between master/slave)
Ambient temperature	-20 to +55 °C
Protection type	IP 65 + IP 67
Protection class	III, operation on protective low voltage
Housing material	Aluminum
Window material	Polycarbonate
Mounting	Rear side, T-shaped slot, or using adjustable brackets SFB E180 (optional)

		Resolution (mm)	Number of beams	Protective field height	Master / slave 2	Total height	Conf. range	Product description		
Safety level			mm	mm	mm	mm	mm	Master	Slave	Slave 2
	Finger protection 14 mm	15	160	-	213	3	6	-	SLI4-151-S	-
		30	310	387	363			SLI4-301-M	SLI4-301-S	SLI4-301-S2
		45	460	537	513			SLI4-451-M	SLI4-451-S	SLI4-451-S2
		60	610	687	663			SLI4-601-M	SLI4-601-S	SLI4-601-S2
		75	760	837	813			SLI4-751-M	SLI4-751-S	SLI4-751-S2
		90	910	987	963			SLI4-901-M	SLI4-901-S	SLI4-901-S2
		105	1,060	1,137	1,113			SLI4-1051-M	SLI4-1051-S	SLI4-1051-S2
		120	1,210	1,287	1,263			SLI4-1201-M	SLI4-1201-S	SLI4-1201-S2
		135	1,360	1,437	1,413			SLI4-1351-M	SLI4-1351-S	SLI4-1351-S2
		150	1,510	1,587	1,563			SLI4-1501-M	SLI4-1501-S	SLI4-1501-S2
		165	1,660	1,737	1,713			SLI4-1651-M	SLI4-1651-S	SLI4-1651-S2
180	1,810	1,910	1,886	SLI4-1801-M	SLI4-1801-S	SLI4-1801-S2				
	Hand protection 30 mm	8	160	-	213	4	12	-	SLI4-153-S	-
		13	260	337	313			SLI4-253-M	SLI4-253-S	SLI4-253-S2
		16	310	387	363			SLI4-303-M	SLI4-303-S	SLI4-303-S2
		23	460	537	513			SLI4-453-M	SLI4-453-S	SLI4-453-S2
		31	610	687	663			SLI4-603-M	SLI4-603-S	SLI4-603-S2
		38	760	837	813			SLI4-753-M	SLI4-753-S	SLI4-753-S2
		46	910	987	963			SLI4-903-M	SLI4-903-S	SLI4-903-S2
		53	1,060	1,137	1,113			SLI4-1053-M	SLI4-1053-S	SLI4-1053-S2
		61	1,210	1,287	1,263			SLI4-1203-M	SLI4-1203-S	SLI4-1203-S2
		68	1,360	1,437	1,413			SLI4-1353-M	SLI4-1353-S	SLI4-1353-S2
		76	1,510	1,587	1,563			SLI4-1503-M	SLI4-1503-S	SLI4-1503-S2
		88	1,660	1,737	1,713			SLI4-1653-M	SLI4-1653-S	SLI4-1653-S2
		91	1,810	1,910	1,886			SLI4-1803-M	SLI4-1803-S	SLI4-1803-S2

	Resolution (mm)	Number of beams	Protective field height	Total height		Conf. range		Product description			
				Master / slave 2	Slave	Low Range to	High Range to	Master	Slave	Slave 2	
Safety level		mm	mm	mm	mm	mm	mm	Master	Slave	Slave 2	
	Hand protection 40mm	6	160	-	213	4	12	-	SLI4-154-S	-	
		8	260	337	313			SLI4-254-M	SLI4-254-S	SLI4-254-S2	
		11	310	387	363			SLI4-304-M	SLI4-304-S	SLI4-304-S2	
		16	460	537	513			SLI4-454-M	SLI4-454-S	SLI4-454-S2	
		21	610	687	663			SLI4-604-M	SLI4-604-S	SLI4-604-S2	
		26	760	837	813			SLI4-754-M	SLI4-754-S	SLI4-754-S2	
		31	910	987	963			SLI4-904-M	SLI4-904-S	SLI4-904-S2	
		36	1,060	1,137	1,113			SLI4-1054-M	SLI4-1054-S	SLI4-1054-S2	
		41	1,210	1,287	1,263			SLI4-1204-M	SLI4-1204-S	SLI4-1204-S2	
		46	1,360	1,437	1,413			SLI4-1354-M	SLI4-1354-S	SLI4-1354-S2	
		51	1,510	1,587	1,563			SLI4-1504-M	SLI4-1504-S	SLI4-1504-S2	
		56	1,660	1,737	1,713			SLI4-1654-M	SLI4-1654-S	SLI4-1654-S2	
		61	1,810	1,910	1,886			SLI4-1804-M	SLI4-1804-S	SLI4-1804-S2	
			Body protection 50mm	4	160			-	213	4	12
8	310			387	363	SLI4-305-M	SLI4-305-S	SLI4-305-S2			
12	460			537	513	SLI4-455-M	SLI4-455-S	SLI4-455-S2			
16	610			687	663	SLI4-605-M	SLI4-605-S	SLI4-605-S2			
20	760			837	813	SLI4-755-M	SLI4-755-S	SLI4-755-S2			
24	910			987	963	SLI4-905-M	SLI4-905-S	SLI4-905-S2			
28	1,060			1,137	1,113	SLI4-1055-M	SLI4-1055-S	SLI4-1055-S2			
32	1,210			1,287	1,263	SLI4-1205-M	SLI4-1205-S	SLI4-1205-S2			
36	1,360			1,437	1,413	SLI4-1355-M	SLI4-1355-S	SLI4-1355-S2			
40	1,510			1,587	1,563	SLI4-1505-M	SLI4-1505-S	SLI4-1505-S2			
44	1,660			1,737	1,713	SLI4-1655-M	SLI4-1655-S	SLI4-1655-S2			
48	1,810	1,910	1,886	SLI4-1805-M	SLI4-1805-S	SLI4-1805-S2					
	Body protection 90mm	4	310	387	363	4	12	SLI4-309-M	SLI4-309-S	SLI4-309-S2	
		6	460	537	513			SLI4-459-M	SLI4-459-S	SLI4-459-S2	
		8	610	687	663			SLI4-609-M	SLI4-609-S	SLI4-609-S2	
		10	760	837	813			SLI4-759-M	SLI4-759-S	SLI4-759-S2	
		12	910	987	963			SLI4-909-M	SLI4-909-S	SLI4-909-S2	
		14	1,060	1,137	1,113			SLI4-1059-M	SLI4-1059-S	SLI4-1059-S2	
		16	1,210	1,287	1,263			SLI4-1209-M	SLI4-1209-S	SLI4-1209-S2	
		18	1,360	1,437	1,413			SLI4-1359-M	SLI4-1359-S	SLI4-1359-S2	
		20	1,510	1,587	1,563			SLI4-1509-M	SLI4-1509-S	SLI4-1509-S2	
		22	1,660	1,737	1,713			SLI4-1659-M	SLI4-1659-S	SLI4-1659-S2	
		24	1,810	1,910	1,886			SLI4-1809-M	SLI4-1809-S	SLI4-1809-S2	
	Beam separation										
	Beams 2-3-4	500	2	510	677	653	4	12	SLI4-2B-M	SLI4-2B-S	SLI4-2B-S2
		400	3	810	977	953			SLI4-3B-M	SLI4-3B-S	SLI4-3B-S2
		300	4	910	1077	1053			SLI4-4B-M	SLI4-4B-S	SLI4-4B-S2

Interface relay - for safety light curtains / grids SLI...



- Can be used for all safety light curtains / grids with an integrated EDM (external device monitoring) function
- Function with two guided-contact safety relays
- Control and monitoring carried out directly by light curtains / grids



Technical data (typ.)	+20 °C, 24VDC
Safety relay outputs*	NO (2x) + NC (1x), 2 A, 250VAC
Reaction time	< 20 ms
Service voltage	19.2 to 28.8V DC
Connection	to terminal strip
Ambient temperature	0 to +55 °C
Protection type	IP 20 for housing IP 2X for terminal strip
Mounting	on top-hat rail in accordance with EN 50022-35 standard
Dimensions - HxLxD	101 x 35 x 120 mm
Description	Product description
Interface relay for all light curtains / grids SLI...	SR-0

* Each NO safety switching output is interrupted twice by the two relays.

MODSI - the modular safety system



MODSI is the new modular and configurable safety system from di-soric.

This safety system is able to monitor and control a wide variety of safety equipment at the same time. This can include safety light curtains / grids, safety light barriers, emergency stop switches, safety mats, mechanical or magnetic safety door switches, two-handed controls, and much more.

Thanks to the modular design and expandable design, the I/O configuration and function can be adapted to the respective requirements of a wide variety of applications. As such, MODSI is an extremely versatile and flexible safety system.

It features both digital outputs and relay outputs.

These outputs can be switched immediately or with a delay.

MODSI is certified for the maximum safety levels as defined by industrial safety standards:

SIL 3, SILCL 3, PL e, Cat. 4



Main features

- ◆ Compact design: Design size of each individual module 22.5x99x114.5 mm
- ◆ Removable terminal strips, screw contacts
- ◆ Can be used with the most common safety sensors
- ◆ Data transmission possible over fieldbus systems
- ◆ MS-SD - Safety Designer
 - Simple and intuitive software with a graphical user interface
- ◆ A large selection of safety functions and logical operators that can be configured using the software (starting on page 51)
- ◆ MS-M - Configuration Memory
 - Removable memory card for backing up and transferring configuration data
- ◆ MS-SC - Safety Communication
 - Communication between the modules over a 5-way high-speed bus
- ◆ Max. 14 expansion modules in addition to the M1 master
- ◆ Max. 128 inputs and 16 OSSD safety outputs (pairs)
- ◆ Remote maintenance/control of the MS expansion modules is possible over the MS-SC bus (a range of up to 100 m)
- ◆ Digital safety inputs that can be programmed individually or in pairs with the option for monitoring using dedicated output signals
- ◆ Filters and delays can be programmed separately for each input
- ◆ Delays can be programmed for output activation and deactivation
- ◆ Independent control of output pairs possible
- ◆ Programmable diagnostic output signals
- ◆ Easy diagnostics using LED displays on the front side and the bus expansion modules as well as configuration software MS-SD



Compact design



MS-M
Configuration Memory



MS-SC
Safety Communication

MS-1 master main module



- Programmable main unit, able to control any other expansion unit
- Can also be used as a stand-alone device
- Internal LOG file with the last 5 configuration changes in chronological order and the change date
- Slot for optional MS-M configuration memory card
- MS-SC rear bus for connection with other expansion modules
- The MS-1 master is equipped with a serial USB 2.0 bus for connecting to a computer.
The MS-SD (MS Safety Designer) configuration software is run on this computer

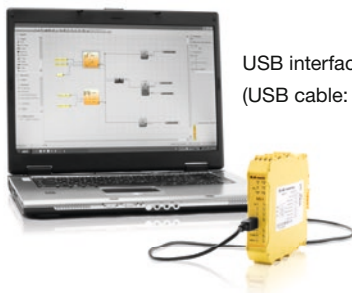



USB interface for computer connection
(USB cable: USB-A-M-1.8)



Technical data (typ.)	+20 °C, 24VDC
Safety level	SIL 3 – SILCL 3 in accordance with IEC 61508 - IEC 62061 PL e – Cat. 4 in accordance with ISO 13849-1
Safety inputs	8
Safety outputs (OSSD)	PNP (2 pairs), 400 mA
Programmable signal outputs	PNP (2x), 100 mA
Test outputs	4
Inputs for start / restart and external device monitoring - EDM	2
LED displays	Status input / output Error diagnostics
Service voltage	19.2 to 28.8V DC
Connections	Removable terminal strips, screw contacts
Ambient temperature	-10 to +55 °C
Protection type	IP 20 for housing IP 2X for terminal strip
Mounting	on top-hat rail in accordance with EN 50022-35 standard
Dimensions - H x L x D	99 x 22.5 x 114.5 mm
Description	Product description
Main module for the modular safety system	MS-1

MS expansion modules

	Expansion module	Configuration memory for main module	Safety communication for main module/expansion module	Safety inputs	PNP safety outputs, 400 mA OSSD (number of pairs)	PNP signal outputs, 100 mA (programmable)	Test outputs	Safety relay outputs: NO (2x) NC (1x) 6A 250 V AC NO (4x) NC (2x) 6A 250 V AC	Inputs for start / restart and external device monitoring (EDM)	Service voltage (VDC)	Protection class: IP 20 housing, IP 2X terminal strip	Ambient temperature (°C)	
Modular safety systems												Product description	
SIL 3-3 SILCL 3 safety level, in accordance with IEC 61508 - IEC 62061													
	■			8	2	2	4		2	24V ± 10%	■	-10 to 55	MS-I8-02
	■			8			4						MS-I8
	■			16	-	-	4		-				MS-I16
	■			12			8						MS-I12-T8
	■												MS-O2
	■			-	4	4	-		4				MS-O4
	■												MS-R2
	■			-	-	-	-	■	-				MS-R4
	■							4 (NO)					MS-OR4
						8	4 (NO)		MS-OR4-S8				
	■			-	-	-	-		-				MS-M
		■		-	-	-	-		-				MS-SC

Expansion modules for bus diagnostics and data transmission MS-B...

- For connection to the most frequently used industrial fieldbus systems
- The MS-Bx expansion modules are equipped with a serial USB 2.0 bus for connecting to a computer to ensure fast and easy configuration
- LED displays for error diagnostics
- Connection to MS-1 master over a proprietary MS-SC bus
- Including an MS-SC connector for connecting to the MS-1 master

	Description	Product description
	Profibus DP - expansion module	MS-BP
	DeviceNET - expansion module	MS-BD
	CANopen - expansion module	MS-BC
	Ethernet IP - expansion module	MS-BEI
	EtherCAT - expansion module	MS-BEC
	PROFINET - expansion module	MS-BEP
	Universal Serial Bus - expansion module	MS-BU

MS-CTx interface modules - enable the connection of relocated expansion modules over the MS-SC bus



- Ideal solution for the interconnection of the safety functions of several machines on a single production line
- Up to 50m for each individual connection (total range of up to 250m)
- LED displays for output status
- Connection to MS-1 master over a proprietary MS-SC bus
- Including an MS-SC connector for connecting to the MS-1 master



Description	Product description
MS-CT1* - Interface with 1 connection (1 input <u>or</u> 1 output)	MS-CT1
MS-CT2 - Interface with 2 connections (1 input <u>and</u> 1 output)	MS-CT2

Connection variant

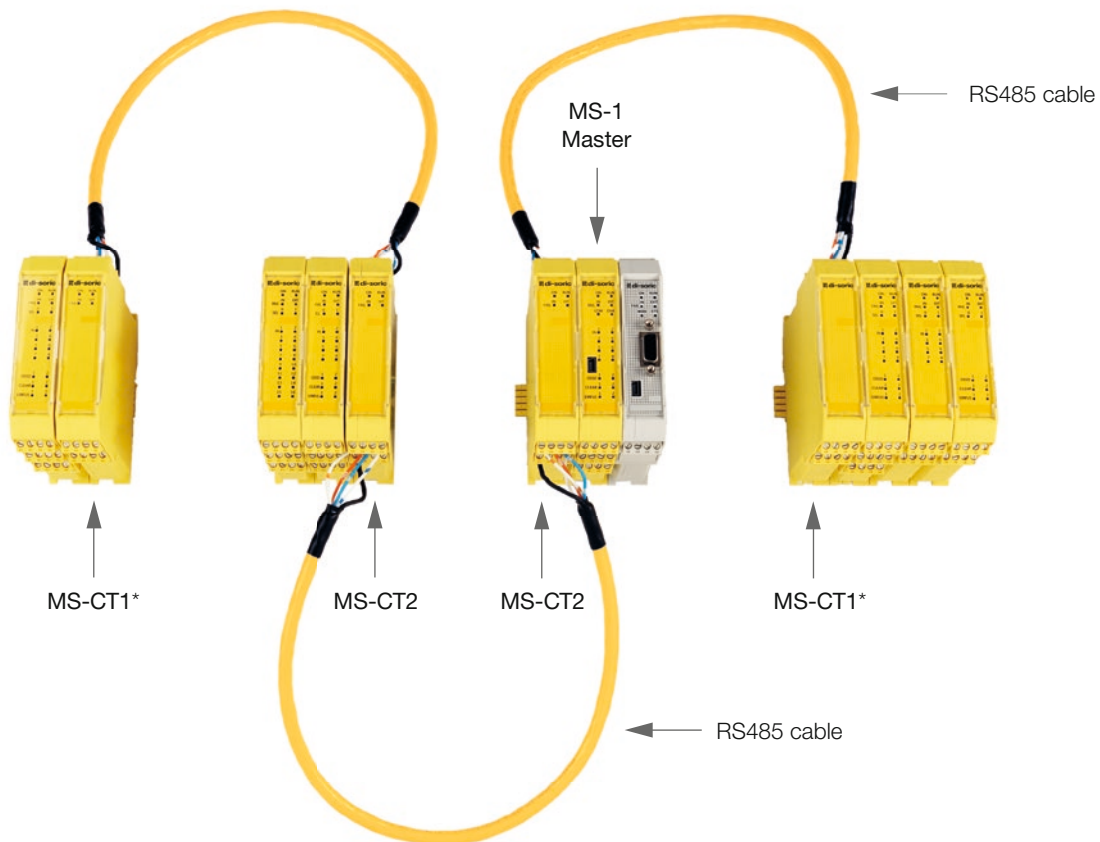

* End or start of the network

MS - expansion modules

MS-Vx Expansion modules for safety speed monitoring



- Safety speed monitoring (up to the safety level PLe) for stops, maximum speed, speed ranges and rotational direction
- Up to 4 selectable speed thresholds (freely configurable using MS-SD) for each logical output (axis).
- Each module contains two outputs logically linked over MS-SD and, therefore, is capable of monitoring up to two axes that are independent of each other
- Maximum input frequency for incremental encoder: 500 KHz (300 KHz for HTL incremental encoder)
- Maximum input frequency for inductive proximity switches: 5 KHz
- LED for input status and error diagnostics
- RJ-45 connections for incremental encoder (1 for MS-V1, 2 for MS-V2)
- Terminal strips for inductive proximity switches
- Connection to MS-1 master over a proprietary MS-SC bus
- Including an MS-SC connector for connecting to the MS-1 master

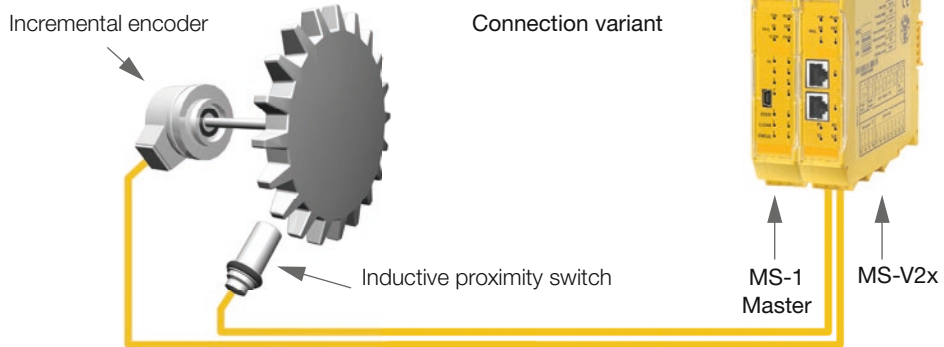









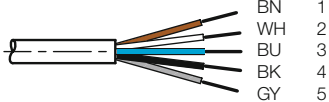

Description	Product description
Inputs for 2 inductive PNP/NPN proximity switches	MS-V0
Inputs for 1 TTL incremental encoders + 1 or 2 inductive PNP/NPN proximity switches	MS-V1T
Inputs for 1 HTL incremental encoders + 1 or 2 inductive PNP/NPN proximity switches	MS-V1H
Inputs for 1 sin/cos incremental encoders + 1 or 2 inductive PNP/NPN proximity switches	MS-V1S
Inputs for 1 or 2 TTL incremental encoders + 1 or 2 inductive PNP/NPN proximity switches	MS-V2T
Inputs for 1 or 2 HTL incremental encoders + 1 or 2 inductive PNP/NPN proximity switches	MS-V2H
Inputs for 1 or 2 sin/cos incremental encoders + 1 or 2 inductive PNP/NPN proximity switches	MS-V2S

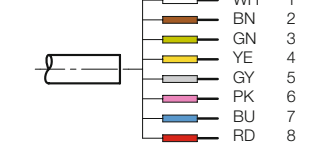
MS - technical characteristics

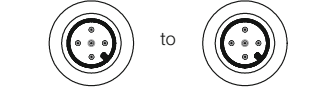
Characteristics	Module:	MS-1	MS-I8-O2	MS-I8	MS-I16	MS-I12-T8	MS-O2	MS-O4
USB connection		■	-	-	-	-	-	-
MS-M card slot		■	-	-	-	-	-	-
Connection to MS-SC bus		■	■	■	■	■	■	■
MS-SC connector including		-	■	■	■	■	■	■
Safety level		SIL 3 - SILCL 3 in accordance with IEC 61508 - IEC 62061 / PL e - Cat. 4 in accordance with ISO 13849-1						
Safety inputs		8	8	8	16	12	-	-
Safety outputs (OSSD)	PNP 400mA	2 pairs	2 pairs	-	-	-	2 pairs	4 pairs
Programmable signal outputs	PNP 100mA	2	2	-	-	-	2	4
Test outputs		4	4	4	4	8	-	-
Inputs for start/restart and EDM		2	2	-	-	-	2	4
LED displays		Input / output status and error diagnostics						
Service voltage		19.2 to 28.8V DC						
Connections		Removable terminal strips, screw contacts						
Ambient temperature		-10to+55°C						
Storage temperature		-10to+85°C						
Protection type		IP20 for housing, IP2X for terminal strip						
Mounting		on top-hat rail in accordance with EN 50022-35 standard						
Dimensions - HxLxD		99 x 22.5 x 114.5 mm						

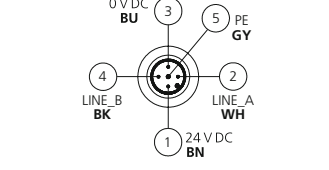
Characteristics	Module:	MS-R2	MS-R4	MS-OR4	MS-OR4-S8	MS-Bx	MS-CTx	MS-Vx	
USB connection		-	-	-	-	■	-	-	
Connection to MS-SC bus		-	-	■	■	■	■	■	
MS-SC connector including		-	-	■	■	■	■	■	
Safety level		SIL 3 - SILCL 3 in accordance with IEC 61508 - IEC 62061 PL e - Cat. 4 in accordance with ISO 13849-1					-	SIL 3 - SILCL 3 PL e - Cat. 4	
Safety inputs		-	-	-	-	-	-	1 - 4	
Programmable signal outputs	PNP 100mA	-	-	-	8	-	-	-	
Safety relay outputs	6A 240V AC	NO (2x) + NC (1x)	NO (4x) + NC (2x)	NO (4x)	NO (4x)	-	-	-	
Inputs for start/restart and EDM		1 (EDM)	2 (EDM)	4	4	-	-	-	
LED displays		Output status				Diagnostics	Output status	Input status + diagnostics	
Service voltage		19.2 to 28.8V DC							
Connections		Removable terminal strips, screw contacts							
Ambient temperature		-10to+55°C							
Storage temperature		-10to+85°C							
Protection type		IP20 for housing, IP2X for terminal strip							
Mounting		on top-hat rail in accordance with EN 50022-35 standard							
Dimensions - HxLxD		99 x 22.5 x 114.5 mm							

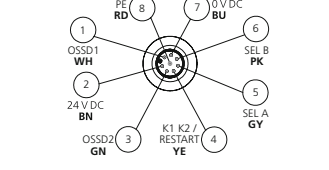
Accessories



		straight	angled	Cable length (m)	Product description
Connection cable for SLB2..., SLBx4... and for SLI2..., SLIx4... transmitters					
		■		5	CD 5
				10	CD 10
				15	CD 15
				20	CD 20
				25	CD 25
				50	CD 50
			■	5	CD 95
				10	CD 910
				15	CD 915
Connection cable for SLI2..., SLIx4... receivers					
		■		5	C8D 5
				10	C8D 10
				15	C8D 15
				25	C8D 25
				40	C8D 40
			■	5	C8D 95
				10	C8D 910
				15	C8D 915
Connection cable between SLI2..., SLIx4... master and slave					
		■		0.3	CDS 03
				3	CJBE 3
				5	CJBE 5
				10	CJBE 10
				25	CJBE 25
Field-attachable plug connector for SLB2..., SLBx4... and for SLI2..., SLIx4... transmitters					
		■			CDM 9
					CDM 99
Field-attachable plug connector for SLI2..., SLIx4... receivers					
		■			C8D M 11
					C8D M 911

Standard brackets for light curtains / grids		Product description
	Set with 4 standard brackets, suitable for all light curtains / grids up to a protective field height of 1060 mm.	SA 4
	Set with 6 standard brackets, suitable for all light curtains with a protective field height of 1,210 mm or higher.	SA 6

Each set includes the brackets necessary for transmitters and receivers. A set is already included in the scope of delivery for each light curtain / grid.

Adjustable brackets for light curtains / grids

The brackets SFB E enable rotation of the light curtains / grids along the longitudinal axis and adjustment of the vertical and horizontal position. Use of brackets SFB E is recommended for aligning the light curtains / grids that operate across long distances or on multiple sides using deflection mirrors.

Adjustable brackets SFB 4E / SFB 6E	Adjustable brackets SFB E 180:
 <p>SFB 4E: Suitable for all light curtains / grids up to a protective field height of 1,060 mm.</p> <p>SFB 6E: Suitable for all light curtains with a protective field height of 1,210 mm or higher.</p>	 <p>SFB 180E: Suitable for all light curtains and light grids. Adjustment range up to 180°.</p>

Description	Product description
Set with 4 adjustable brackets, adjustment range of 14°	SFB 4E
Set with 6 adjustable brackets, adjustment range of 14°	SFB 6E
Set with 4 adjustable brackets, adjustment range of 180°	SFB E180

Each set includes the brackets necessary for transmitters and receivers.

Vibration dampers for light curtains / grids		
	Unprotected safety light curtains / grids can be severely damaged if they are subjected to strong vibrations. These vibrations are generated for presses, weaving machines, etc. and can then be transferred to the attached light curtains / grids.	
	In these cases, the use of vibration-damping brackets is highly recommended!	
	Vibration dampers SAV can reduce these vibrations caused by machines easily, thereby preventing damage to the light curtains / grids.	
	Description	For the protective field height (mm)
Set with 4 vibration dampers	160	SAV 4E
Set with 8 vibration dampers	260 to 1,060	SAV 8E
Set with 12 vibration dampers	1,210 to 1,810	SAV 12E

Each set includes the dampers necessary for transmitters and receivers.

Accessories

Mounting columns and deflection mirrors

The FMC holding columns for safety light curtains / grids and deflection mirrors offer a durable floor-mounting option, fast installation and simple and precise adjustment of the optical alignment of the system.

Mounting columns



FMC-EB

FMC-B12

- Effortless installation and uninstallation of the light curtains / grids with the option of easy height adjustment of the first beam
- Models with a rear PG11 connection are also available
- Columns made from extruded aluminum with adjustable angular orientation
- Steel base for floor mounting, with options for adjusting the vertical column axis
- Built-in, spherical spirit level for correct vertical positioning
- Steel anchor bolts are included in the scope of delivery for the base



Spherical spirit level

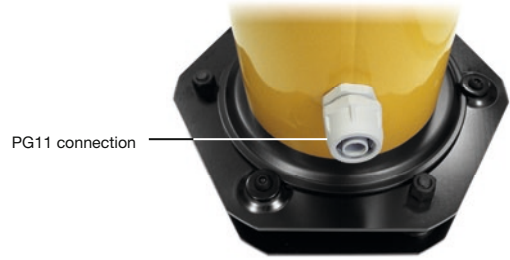

PG11 connection

Mounting columns with deflection mirrors



FMC-SB







FMC-S

- Pre-mounted deflection mirrors for creating rotational protective field heights with up to 4 sides
- Models with pre-mounted and freely adjustable deflection mirrors for safety light grids with 2, 3 or 4 beams are also available
- Special models equipped with a protective anti-fragmentation film on the mirrors available upon request
- Columns made from extruded aluminum with adjustable angular orientation
- Steel base for floor mounting, with options for adjusting the vertical column axis
- Optical power reduction factor of 15% for each mirror
- Built-in, spherical spirit level for correct vertical positioning
- Steel anchor bolts are included in the scope of delivery for the base

Mounting columns with base	A mm	B mm	C mm	Product description
	Mounting columns for light curtains / grids			
	1,000	1,055	1,034	FMC-EB2 FMC-EB2R
	1,330	1,385	1,364	FMC-EB4 FMC-EB4R
	1,670	1,725	1,704	FMC-EB1700 FMC-EB1700R
	1,970	2,025	2,004	FMC-EB2000 FMC-EB2000R
	1,200	1,255	1,234	FMC-B12
Mounting columns with deflection mirrors				
	1,000	1,055	1,034	FMC-S2 FMC-SB2
	1,200	1,255	1,234	FMC-S3 FMC-SB3
	1,330	1,385	1,364	FMC-S4 FMC-SB4
	1,670	1,725	1,704	FMC-S1700
	1,970	2,025	2,004	FMC-S2000
<p>The adjustable steel bases FMC-CB or FMC-CBL are required to ensure optimum mounting of mounting columns on the floor.</p>				

Base for mounting columns	Dimensions	Product description
	202 x 224 x 58 mm	FMC-CB *
	202 x 224 x 37 mm	FMC-CBL
<p>Steel anchor bolts are included in the scope of delivery Order a base for each respective column.</p>		
<p>* The steel bases FMC-CB can be adjusted precisely. They consist of a double plate with steel springs for fine adjustment</p>		

Accessories

		For light curtains / grids with...					
		Protective field height up to (mm)	Protective field height up to (mm)	2 beams	3 beams	4 beams	
Mounting columns for light curtains / grids		1,210	1,810				Product description
	Without PG11 connection			■			FMC-EB2
					■	■	FMC-EB4
		■					FMC-EB1700
			■				FMC-EB2000
	Without PG11 connection			■			FMC-EB2R
					■	■	FMC-EB4R
		■					FMC-EB1700R
			■				FMC-EB2000R
Aluminum profile with fastening grooves				■	■	■	FMC-B12
Mounting columns with deflection mirrors							
	Premounted deflection mirror			■			FMC-S2
					■		FMC-S3
						■	FMC-S4
		■					FMC-S1700
			■				FMC-S2000
	Freely adjustable deflection mirrors			■			FMC-SB2
					■		FMC-SB3
						■	FMC-SB4
Base for mounting columns							
	202 x 224 x 58 mm			■	■	■	FMC-CB
	202 x 224 x 37 mm	■	■	■	■	■	FMC-CBL



The following must be taken into account when using deflection mirrors:

- The working distance (range) is yielded from the sum of the lengths of all access sides of the monitored area.
- The maximum range between the transmitter and receiver is reduced by 15% for each mirror.
- The mirrors must be positioned so that the safety distance to the hazard zone can be maintained on each access side.
- If protective devices are implemented across long distances are equipped with deflection mirrors on multiple sides, the laser alignment device LAD 4 is used to align the light curtains / grids with each quickly and correctly (see page 200).

Deflection mirrors SP ...



Deflection mirrors can be used to create rotational protective fields in areas that have access points on multiple sides at significantly reduced costs. This solution does not require more than one light curtain / grid.

- Deflection mirrors with a height of 250 to 1900 mm for creating rotational protective fields with up to 4 sides
- Angular orientation adjustable using two supplied brackets
- Special models equipped with a protective anti-fragmentation film on the mirrors available upon request
- Optical power reduction factor of 15% for each mirror
- Extruded aluminum section bar

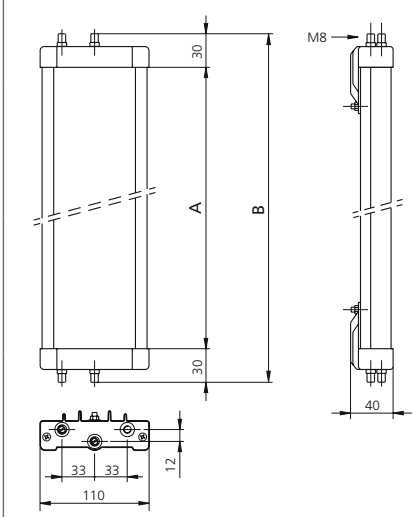
Deflection mirrors	A (mm)	B (mm)	Dimensions (mm)	For light curtains with a protective field height of (mm):	For light grids with			Product description
					2	3	4	
	250	310	310 x 110 x 40	160				SP 100 S
	400	460	460 x 110 x 40	310				SP 300 S
	540	600	600 x 110 x 40	460				SP 400 S
	715	775	775 x 110 x 40	610	■			SP 600 S
	885	945	945 x 110 x 40	760				SP 700 S
	1,060	1,120	1,120 x 110 x 40	910		■		SP 900 S
	1,230	1,290	1,290 x 110 x 40	1,060			■	SP 1100 S
	1,400	1,460	1,460 x 110 x 40	1,210				SP 1200 S
	1,450	1,510	1,510 x 110 x 40	1,360				SP 1300 S
	1,600	1,660	1,660 x 110 x 40	1,510				SP 1500 S
	1,750	1,810	1,810 x 110 x 40	1,660				SP 1600 S
1,900	1,960	1,960 x 110 x 40	1,810				SP 1800 S	

Accessories

Laser alignment device for light curtains / grids SLxx...



The laser alignment device LAD 4 enables quick, reliable optical alignment of the safety light curtains / grids. It can also be used with mounting columns FMC. The LAD 4 emits a laser beam with visible red light and a range of up to 100 m. Your application is ideal for aligning light curtains / grids that are implemented across long distances or on multiple sides using deflection mirrors.



Dimensions in mm:

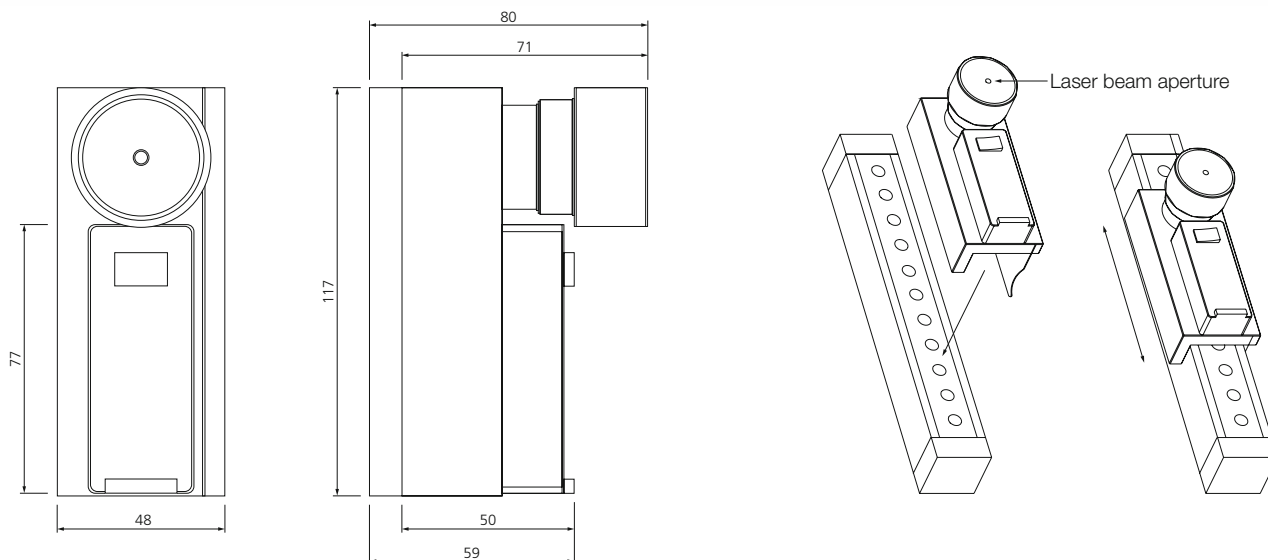

Technical data (typ.)

Emitted light	Red-light laser, 650 nm
Laser safety class	II (EN 60825-1)
Operating distance	100 m
Laser beam divergence	< 0.5 mrd
Laser power	1,000 μ W
Service voltage	3V DC
Power supply	2x 1.5 V alkaline batteries type AAA
Housing material	Plastic
Fastening type	Quick fastening to the light curtain / grid or the mounting column
Dimensions HxLxD	117 x 48 x 80 mm

Product description

Laser alignment device	LAD 4
------------------------	-------

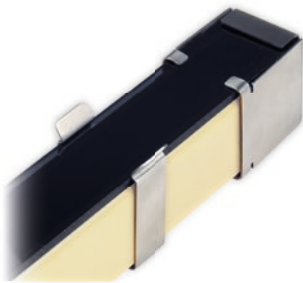

Safety screens for light curtains / grids



PSE safety screens made of polycarbonate protect the front screen of the safety light curtains / grids from damage resulting from welding sparks, scratches and aggressive media. Each PSE set contains 4 safety screens (2 of which are replacement parts) and are selected according to the protective field height of the safety light curtain / grid.

The fastening set SFS E is required for fastening. Each set consists of a pair of stainless steel clamps and 4 end caps.

Thanks to quick and easy installation using stainless steel clamps, the safety screen can be replaced without any problems if it gets damaged.

Safety screens for safety light curtains	For the protective field height (mm)	Product description
Safety screens  <hr/> Fastening set  End cap Clamps	160	PSE 150
	310	PSE 300
	460	PSE 450
	610	PSE 600
	760	PSE 750
	910	PSE 900
	1,060	PSE 1050
	1,210	PSE 1200
	1,360	PSE 1350
	1,510	PSE 1500
1,660	PSE 1650	
1,810	PSE 1800	
Safety screens for safety light grids	For the protective field height (mm)	Product description
Safety screen set for 2-beam light grid	510	PSE 2B
Safety screen set for 3-beam light grid	810	PSE 3B
Safety screen set for 4-beam light grid	910	PSE 4B

Fastening set for PSE safety screens	Product description
Stainless steel clamps and end caps for safety screens	SFS E

Test rod



The test rod is an aluminum cylinder with a matte surface that is used to ensure that no beams are diverted due to reflective surfaces after the safety light curtains have been installed.

This is tested by slowly moving the test rod (\varnothing = resolution) in the center and along each side of the monitoring area.

The green LED of the receiver must be off for the entirety of the test.

Description	Diameter (mm)	Product description
Test rod for light curtains with a 14 mm resolution	\varnothing 14	TR 14
Test rod for light curtains with a 20 mm resolution	\varnothing 20	TR 20
Test rod for light curtains with a 30 mm resolution	\varnothing 30	TR 30
Test rod for light curtains with a 40 mm resolution	\varnothing 40	TR 40
Test rod for light curtains with a 50 mm resolution	\varnothing 50	TR 50

Accessories

A comprehensive addition to and optimization of our sensors and lighting products for almost all applications.

- Sensor tester
- Connection cable
- Connector / adapter plug
- Counter module with reset function in M8 and M12 connector version
- Logic distributor
- M8 and M12 function adapters:
 - pnp threshold switch
 - npn/pnp converter
 - pnp/npn converter
 - pnp inverter
 - pnp antivalence device
 - pnp pulse stretcher
- IO-Link device
- Reflectors
- Light measurement accessories
- Installation systems



Sensor tester ST 7PNG

The di-soric sensor tester is used to test the proper functioning of all pnp, npn and push-pull switching outputs. A clear visible and audible signal is used to forward the output signal of the sensors. Practical quick-action sockets and an internal battery power supply ensure fast and easy use. A perfectly tailored sensor tester set (ST set) includes a sensor tester and all required accessory parts.





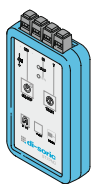







Sensor tester for pnp, npn and push-pull sensors		Product description
Size without protective casing	135 x 76 x 27 mm	
No-load current	< 40mA	
Output voltage	18V DC	
Display	LED: green - operation, yellow - switching outputs	
Protection type	IP 21	
Housing material	ABS, black plastic	
Material	Silicone (protective casing)	
Connection	Color-coded quick-action sockets	
Current limiting	60mA in battery operation 240mA in operation with external power supply	
Power supply	1.5V batteries type AA (3x) External 12V DC power supply (optional)	
Weight	295g	ST 7PNG



Connection set ST-AS For testing of sensors with switching output and M8 or M12 connector		
	-Connection cable with coupling M12, 4-pin	
	-Adapter plug coupling, M8, 3-pin / connector M12, 4-pin (1x)	
	-Adapter plug coupling, M8, 4-pin / connector M12, 4-pin (1x)	
		ST-AS

Power supply for operation at 220V		
	Output voltage	12VDC, 2000mA
	Connection voltage	100-240VAC, 50-60Hz, 800mA
		ST-PS-12V

	Size	Number of wires	Cable length (m)	Metal coupling ring	Max. permissible service voltage (V AC/DC)	Protection type	Connector material	Cable material PVC, PU coating	Cable material PUR	Product description	Connector material	Cable material PVC	Product description
Connection cable M8													
 straight	M8	3	2.5	■	60	IP 67	PU	■		TKHM-Z-2.5 ²⁾	PVC	■	TKPM-Z-2.5
			5.0							TKHM-Z-5 ²⁾			TKPM-Z-5
		4	2.5	TKHM-Z-2.5/4 ²⁾	TKPM-Z-2.5/4								
			5.0	TKHM-Z-5/4 ²⁾	TKPM-Z-5/4								
 angled	M8	3	2.5	■	60	IP 67	PU	■		TKHM-W-2.5 ²⁾	PVC	■	TKPM-W-2.5
			5.0							TKHM-W-5 ²⁾			TKPM-W-5
		4	2.5	TKHM-W-2.5/4 ²⁾	TKPM-W-2.5/4								
			5.0	TKHM-W-5/4 ²⁾	TKPM-W-5/4								
Connection cable M12													
 straight	M12	4	2.5	■	250	IP 67	PUR	■		VKHM-Z-2.5/4 ²⁾	PVC	■	VKPM-Z-2.5/4
			5.0							VKHM-Z-5/4 ²⁾			VKPM-Z-5/4
			10.0							VKHM-Z-10/4 ²⁾			VKPM-Z-10/4
 straight	M12	5	3.0	■	125	IP 67	PUR	■		VKHM-Z-3/5 ²⁾			
			5.0							VKHM-Z-5/5 ²⁾			
			10.0							VKHM-Z-10/5 ²⁾			
 angled	M12	4	2.5	■	250	IP 67	PUR	■		VKHM-W-2.5/4 ²⁾	PVC	■	VKPM-W-2.5/4
			5.0							VKHM-W-5/4 ²⁾			VKPM-W-5/4
			10.0							VKHM-W-10/4 ²⁾			VKPM-W-10/4
 angled	M12	5	3.0	■	125	IP 67	PUR	■		VKHM-W-3/5 ²⁾			
			5.0							VKHM-W-5/5 ²⁾			
			10.0							VKHM-W-10/5 ²⁾			
 straight	M12	8	2.5	■	30	IP 67	PUR	■		VKHM-Z-2.5/8 ²⁾			
			5.0							VKHM-Z-5/8 ²⁾			
			10.0							VKHM-Z-10/8 ²⁾			
 angled	M12	8	5.0	■	30	IP 67	PUR	■		VKHM-W-5/8 ²⁾			
			10.0							VKHM-W-10/8 ²⁾			
 straight	M12	12	2.5	■	30	IP 67	PUR	■		VKSM-Z-5/12-A ^{1,2)}			
			5.0							VKSM-Z-10/12-A ^{1,2)}			
			10.0										
 straight	M12	12	5.0	■	30	IP 67	PVC	■		VKHM-Z-5/12-A ¹⁾			
			10.0							VKHM-Z-10/12-A ¹⁾			

¹⁾ Shielded cable

²⁾ Drag chain compatible









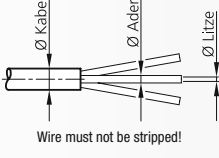
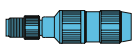
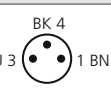

Connectors, adapter plugs

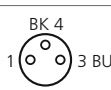
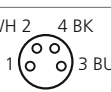
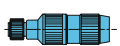
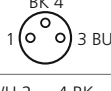
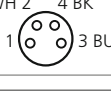
di-soric connectors and adapter plugs are useful accessory parts for tasks such as connecting sensors to available connection cables that are not mechanically compatible. Thanks to this option, extra work can be avoided and the sensors put into operation quickly. di-soric adapter plugs and connectors have a high protection type and are available in different versions.

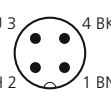
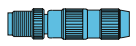
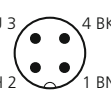
Connectors M8/M12, quick mounting

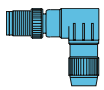
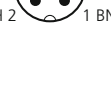
- Metal/plastic housing
- Turnable metal screw
- Quick mounting without tools
- 3-, 4- or 5-pin
- High protection type of up to IP 67

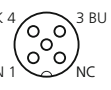

		Connection diagram (View of the connection side)	Connector / number of pins	Coupling / number of pins	Max. voltage range (V)	Ambient temperature (°C)	Clamping area Ø Cable (mm)	Clamping area Ø Wire (mm)	Cross-section of litz wires (mm ²)	Product description
			M8-3	32	-25 to +85	2.5 to 5.1	1.2 to 1.6	0.14 to 0.34	MS-Z-8/0.14	
			M8-4	32	-25 to +85	4.0 to 5.1		0.25 to 0.5	MS-Z-8	
			M8-4	32	-25 to +85	2.5 to 5.1	1.2 to 1.6	0.14 to 0.34	MS-Z-8/4/0.14	
			M8-4	32	-25 to +85	4.0 to 5.1		0.25 to 0.5	MS-Z-8/4	
			M8-3	32	-25 to +85	2.5 to 5.1	1.2 to 1.6	0.14 to 0.34	MK-Z-8/0.14	
			M8-4	32	-25 to +85	4.0 to 5.1		0.25 to 0.5	MK-Z-8	
			M8-4	32	-25 to +85	2.5 to 5.1	1.2 to 1.6	0.14 to 0.34	MK-Z-8/4/0.14	
			M8-4	32	-25 to +85	4.0 to 5.1		0.25 to 0.5	MK-Z-8/4	
Connector M12										
			M12-4	32	-25 to +85	2.9 to 5.1	1.2 to 1.6	0.14 to 0.34	MS-Z-12/4/0.14	
			M12-4	32	-25 to +85	4.0 to 5.1		0.25 to 0.5	MS-Z-12/4	
			M12-4	32	-25 to +85	4.0 to 5.1	1.2 to 1.6	0.25 to 0.5	MS-W-12/4	
			M12-4	32	-25 to +85	2.9 to 5.1		1.0 to 1.6	0.14 to 0.34	MK-Z-12/4
			M12-4	32	-25 to +85	2.9 to 5.1	1.0 to 1.6	0.14 to 0.34	MK-Z-12/4	
			M12-4	32	-25 to +85	4.0 to 5.1		1.2 to 1.6	0.25 to 0.5	MK-W-12/4

Connectors M8/M12, can be mounted

- Plastic housing
- Metal screw
- Solder connection or terminals
- 3-, 4- or 5-pin
- High protection type of up to IP 67









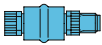

	Connection diagram (View of the connection side)	Connector / number of pins	Coupling / number of pins terminals	Solder connection	Max. voltage range (V)	Clamping area Ø Cable (mm)	Cross-section of litz wires (mm ²)	Product description
		M8-3	■		32	3.5 to 5.0	0.25 to 0.34	BS-Z-8/S
		M8-4						BS-Z-8/4/S
		M8-3		■	32	3.5 to 5.0	0.25 to 0.34	BS-W-8
		M8-4						BS-W-8/4
		M8-3	■		32	3.5 to 5.0	0.25 to 0.34	BK-Z-8/S
		M8-4						BK-Z-8/4/S
		M8-3		■	32	3.5 to 5.0	0.25 to 0.34	BK-W-8
		M8-4		■	32	3.5 to 5.0	0.25 to 0.34	BK-W-8/4
		M12-4	■			4.0 to 6.0	0.75	BS-Z-12
		M12-5				4.0 to 6.0	0.75	BS-Z-12/5
		M12-4	■			4.0 to 6.0	0.75	BS-W-12
		M12-5				4.0 to 6.0	0.75	BS-W-12/5
		M12-4	■			4.0 to 6.0	0.75	BK-Z-12
		M12-5				4.0 to 6.0	0.75	BK-Z-12/5
		M12-4	■			4.0 to 6.0	0.75	BK-W-12
		M12-5				4.0 to 6.0	0.75	BK-W-12/5

Adapter plug

- Turnable metal screw
- 3- or 4-pin
- 4- or 3-pin
- High protection type



	Coupling / number of pins	Connection diagram	Connector / number of pins	Max. voltage range (V)	Max. current-carrying capacity (A)						
	M8-3		M8-4	24	4.0						M8K3/M8S4
	M8-4		M8-3	24	4.0						M8K4/M8S3
	M8-3		M12-3	24	4.0						M8K/M12S
	M8-4		M12-4	24	4.0						M8K/M12S/4
	M12-3		M8-3	24	4.0						M12K/M8S
	M12-4		M8-4	24	4.0						M12K/M8S/4

Counter modules with reset function

- 6-digit LCD display
- Quick and simple mounting directly on the sensor
- Pluggable without any wiring (work)
- Long-term storage of counting values thanks to back-up battery
- Reset via key or connection
- Robust metal housing



Counter module with reset function		
Service voltage	10 to 35 V DC	
Display	LCD display, 6-digit	
Input	pnp	
Counting frequency	10,000 Hz	
Protection type	IP 40	
Housing material	Aluminum, black anodized	
Type		Product description
Counter module with reset button, connector / socket M8, 3-pin		ZR 06B-TSSL
Counter module with reset button and remote reset, connector / socket M12, 4-pin		ZRR 06B-IBS

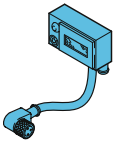

Double logic distributor

- Suitable for all standard sensors
- Switching function AND/OR switchable
- Compact design
- Can be retrofitted quickly and easily
- High temperature use range
- High protection type



Logic distributor, double		
Connection voltage	10 to 35V	
Switching output	pnp, 200 mA, AND/OR	
Switching frequency	6,000Hz	
Protection type	IP 67	
Type		Product description
Logic distributor M8, AND/OR switchable		AV2-AND/OR-PS-TS
Logic distributor M12, AND/OR switchable		AV2-AND/OR-PS-IBS

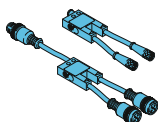

Logic distributor, quadruple

- Integrated switching function with quadruple AND/OR logic
- 4 sensor inputs, M8/3-pin
- 1 output, M12/8-pin
- 4 LEDs for switching status display
- Robust housing
- High protection type



Logic distributor, quadruple		
Connection voltage	10 to 30V	
Current-carrying capacity AND/OR	For each 300mA/logic contact	
Switching output	pnp 4x, pnp-AND 1x, pnp-OR 1x	
Protection type	IP 67 (for use of all slots)	
Type		Product description
AND-M8 dummy plug		BS-Z-8-UND
5m connection cable, 8-pin, angled		VKHM-W-5/8
Logic distributor M8, quadruple		AV4-AND/OR

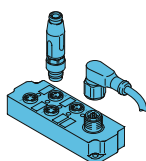

Function adapters

Function adapters can switch sensor-specific functions to the desired function (e.g. pulse stretching). Logic distributors and function adapters are suitable for all conventional sensors, have a compact design and can be retrofitted quickly and easily.

- Suitable for all standard sensors
- Compact design
- Can be retrofitted quickly and easily
- High temperature use range
- LED display for status and switching output

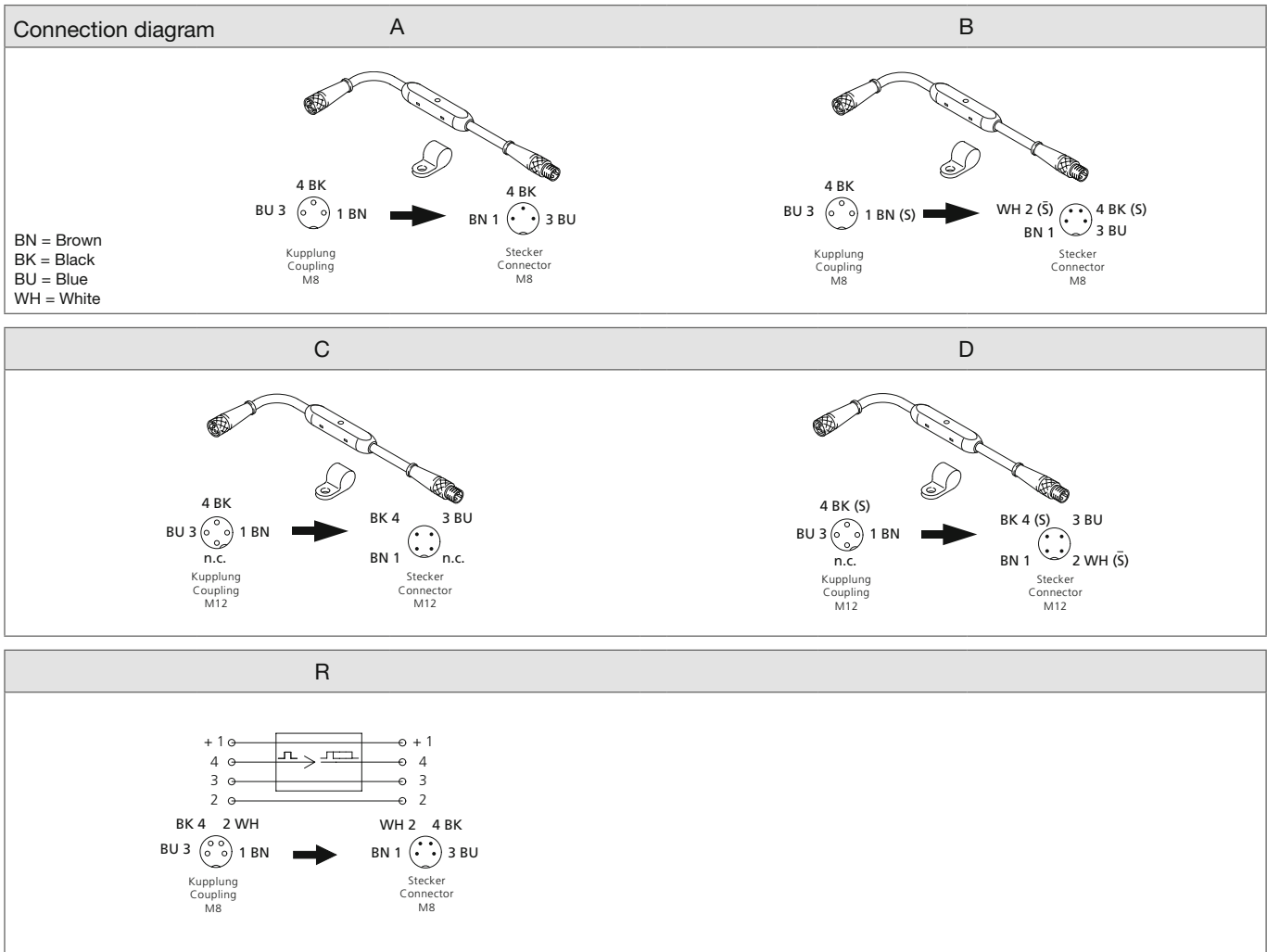

Technical data	+20°C, 24VDC
Service voltage	10 to 35 V DC
Current-carrying capacity	200 mA, short-circuit proof
No-load current	20 mA
Ambient temperature	-20 to +70 °C
Protection type	IP 67
Protection class	III, operation on protective low voltage

	Minimum pulse length (ms)	Output	Switching frequency (Hz)	Connection diagram (the opposite side)	Coupling	Connector	Product description
pnp threshold switch							
	0.1	pnp	< 5,000 Hz	A	M8/3-pin	M8/3-pin	TKHM-Z/TSM-Z/UN
				C	M12/3-pin	M12/3-pin	VKHM-Z/VSM-Z/UN
pnp ⇌ npn converter							
	0.1	nnp	< 5,000 Hz	A	M8/3-pin	M8/3-pin	TKHM-Z/TSM-Z/U
				C	M12/3-pin	M12/3-pin	VKHM-Z/VSM-Z/U
pnp inverter							
	0.1	pnp	< 3,500 Hz	A	M8/3-pin	M8/3-pin	TKHM-Z/TSM-Z/I
				C	M12/3-pin	M12/3-pin	VKHM-Z/VSM-Z/I
pnp antivalence device							
	0.1	pnp	< 3,500 Hz	B	M8/3-pin	M8/4-pin	TKHM-Z/TSM-Z/P4
				D	M12/3-pin	M12/4-pin	VKHM-Z/VSM-Z/P4
pnp pulse stretcher							
	0.1	pnp 1 to 150 ms	< 500 Hz	A	M8/3-pin	M8/3-pin	TKHM-Z/TSM-Z/T
				R	M8/4-pin	M8/4-pin	TKHM-Z/TSM-Z/T4
				C	M12/3-pin	M12/3-pin	VKHM-Z/VSM-Z/T

Accessories for high-performance light barriers

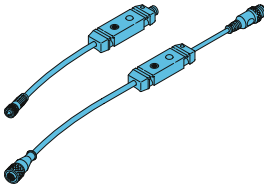
Function modules FM 70... for OSP 12... / OSPQ 12...	Characteristics	Connection	Product description
 <ul style="list-style-type: none"> For adjusting the transmitting power and activating the test function 4-turn potentiometer Protection class IP 67 			
	integrated Sensor test function	M8	FM 70-1-TS

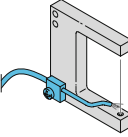
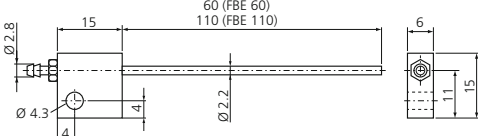

Accessories for forked and angled light barriers

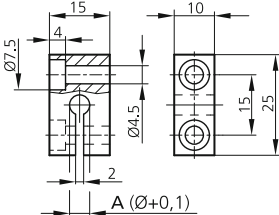

Air nozzles (FBE)		Length	Product description
 <p>These blowing devices are used to blow off dirt and deposits from the lenses. They are installed on the forked/angled light barrier and the pneumatic connection is established using a hose nipple M5.</p> 			
	Flexible	60 mm	FBE 60
	Flexible	110 mm	FBE 110

Accessories for glass fiber-optic cables

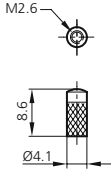

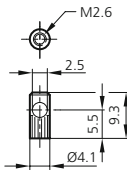

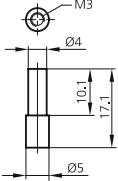

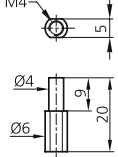
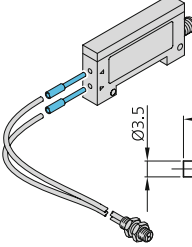
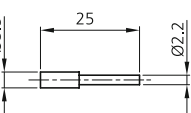
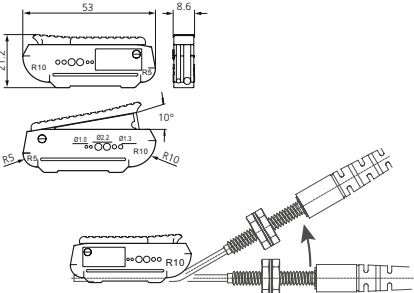
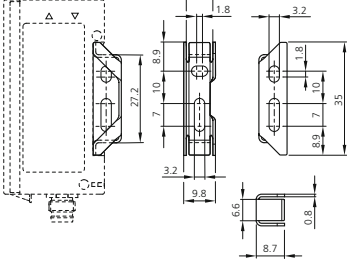



Terminal block			A	Product description
 				
			8.0	KB 8



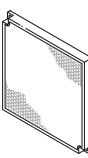
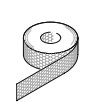

Accessories for plastic fiber-optic cables

Attachment optics for increasing the range for one-way light barriers with sensor probe thread	Light aperture	Thread	Quantity	Product description
  <p>To increase the range by up to 400%, installed on the sensor probe of the transmitter.</p>				
	Axial	M2.6	1	VO M2.6
  <p>For beam deflection, installed on the sensor probe of the transmitter.</p>				
	Radial	M2.6	1	VO M2.6-90

Attachment optics for light spot focus for diffuse sensors with sensor probe thread		Light aperture	Thread	Quantity	Product description
  <p>For light spot focus, the light spot size is $\varnothing 0.5$ at a distance of 8 mm.</p>					
	Axial	M3	1	VO M3	
  <p>For light spot focus, the light spot size is $\varnothing 0.7$ at a distance of 10 mm.</p>					
	Axial	M4	1	VO M4	
Adapter				Quantity	Product description
  <p>For $\varnothing 1$ mm plastic fiber-optic cables Set consists of two pieces.</p>					
			2	AK 2.2/1	
Cutting tool					Product description
 <p>For plastic fiber-optic cables that can be cut to size, including bending gauge R10 for fiber-optic cables with bendable sensor probe.</p>					
				SMB 1	
Fastening bracket for fiber-optic sensors					Product description
 <p>For OLVK 61 ...</p>					
				BW 60	

Reflectors, reflective foils

	Housing design Size (mm)	Mounting	For sensors with red light / infrared light	For sensors with laser light			Temperature stability (°C)	
Reflectors for infrared and red light								Product description
	Ø 10x5.8	M3 x 8.4	■				-20to60	R 10 M3
	Ø 19x5.8	M3 x 9	■				-20to60	R 21 M3
	Ø 42x7	adhesive	■				-20to60	R 42
	Ø 50x8	adhesive	■				-20to60	R 50
	69 x 50 x 9	Ø5mm (2x)	■				to80	R 46
	Ø 84x7.4	Ø4.5mm (1x)	■				-20to60	R 84
	19 x 54 x 9.4	adhesive	■				-20to60	R 19x54
	50 x 80 x 7.2	adhesive	■				-20to60	R 50x80
	51 x 95 x 8	Ø3.3mm (2x)	■				to500	R 51x94/500°
	100 x 100 x 9	Ø 3.8 (2x)	■				-20to60	R 100x100
	100 x 100 x 9	Ø3.8mm (2x)	■				to150	R 100x100/150°
	Width of 50	self-adhesive	■				-20to60	RFP 50/... m

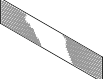
	Housing design Size (mm)	Mounting	For sensors with red light / infrared light	For sensors with laser light			Temperature stability (°C)	
Reflectors and reflective foil for laser light 								
	12.8 x 16.8 x 4.2	adhesive		■			Up to 60	RL 13x17
	42 x 35 x 8.4	Ø 3.3 (2x)		■			Up to 60	RL 42x35
	43 x 20 x 3.5	Ø 3.3 (2x)		■			Up to 110	RL 43x20/110°
	30 x 45 x 5.5	Ø 3.3 (2x)		■			Up to 70	RL 45x30
	50 x 230	adhesive		■			Up to 60	RFPL 50x230

The specified range can be reduced by up to 50% compared to the reference reflector.

IO-LINK basics and technology

Getting to the point.

IO-Link provides a point-to-point connection within any network, fieldbus or backplane bus. The IO-Link master can be installed either directly in the field or in the control cabinet.

Any sensor, actuator or even a combination of the two can be an IO-Link device.

This device is connected to the IO-Link master by a standard connection cable up to 20 m long. The IO-Link device communicates with the IO-Link master using a driver file (the IO-DD – IO-Link Device Description)

and can send and receive signals (binary switch signals or analog signals). IO-Link digitizes these signals directly so that they can

be transferred virtually free of interference.

The international IO-Link standard (in accordance with IEC 61131-9) is now regarded as an **"enabler for Industry 4.0"**

5 REASONS FOR IO-LINK



- 1. Cost reduction**
through reduced stockkeeping
- 2. Implementation of innovative machine concepts**
thanks to consistent communication
- 3. Shortened commissioning times**
with cabling according to standards
- 4. Increased machine productivity**
through independent parameter configuration and identification
- 5. Revolutionizing maintenance**
through self-diagnostics



This is how IO-Link functions

- Standardized bidirectional point-to-point communication interface for the connection of intelligent sensors and actuators
- Backward compatible for binary PNP or push-pull sensors
- Operation modes without IO-Link (SIO mode) or with IO-Link communication
- 3 standardized data transmission rates
4.800 (COM 1), 38.400 (COM 2), 230.400 Baud (COM 3)
- Unshielded standard sensor cables with a cable length up to 20 m
- Cyclical and acyclical data:
Process data (e.g. switch signals or distance values) is transmitted cyclically,
service data (e.g. parameters) is transmitted acyclically

Photos of PLCs and modules: © Siemens AG 2017, all rights reserved.

IO-Link device

The IO-Link Device V4 tool can be used for operating sensors and actuators with an IO-Link interface (IO-Link devices). The IO-Link devices are described by XML device descriptions, so they can be conveniently monitored and configured in multiple languages. The tool is designed for presetting, testing and demonstrating IO-Link devices. The tool is not intended for ongoing operation in production systems.



What we have for you:

3 user levels set up in the IODD:

- OPERATOR
View only
- MAINTENANCE
Teach-in and modification of approved settings
- SPECIALIST
Full access to all available setting options

Only the relevant setting options provided in the IODD and not the exhaustive, full listing of all options,

which would be unhelpful.

The IODD completely developed in accordance with the Smart Sensor Profile and opening up the option to configure the sensor directly over the PLC without additional parameterization software. The Smart Sensor Profile describes the configuration of the most important indexes and subindexes, allowing devices to be addressed directly over the master if the IODD is not accessible at some point.

Software that does away with lengthy explanations

You know intuitively what each property represents.

Technical data

USB	USB 2.0 (Mini USB B)
Power supply	5 V / 500 mA (PC USB) 24 V / 80 mA (IO-Link device from USB) 24 V / 1 A (IO-Link device from the power supply)
Protected against polarity reversal	Yes
Protection class	III
IO-Link communication	IO-Link specification V1.1
IO-Link port class	A
Temperature range for operation	0 to 45 °C
Storage temperature	-40 to 80 °C
Protection type	IP 20

Scope of delivery

- IO-Link device tool
- USB A-B cable
- AC adapter (24 V/24 W)
- "Read Me First" document

Product description

IOL master

Accessories

Connection cable (coupling M12, 4-pin / M12 connector, 4-pin)	VSHM-Z-0.6/VKM-Z/4
Adapter plug (coupling M8, 3-pin / connector M12, 3-pin)	M8K/M12S
Adapter plug (coupling M8, 4-pin / connector M12, 4-pin)	M8K/M12S/4

System requirements for operating the IO-Link device tool V 4.0 software

Computer

- Computer with an available USB 1.1 or 2.0 port
- Ethernet network interface





Operating system

- Windows 7 32/64 bit Service Pack 1
- Windows 8.1 32/64 bit
- Windows 10 64 bit
- Microsoft.Net Framework 3.5

Monitor

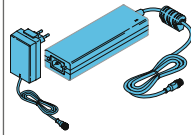
- Resolution of 1024x768 or higher

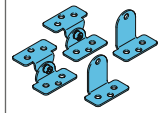
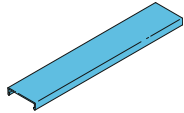
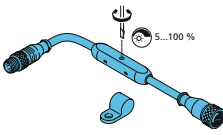

	PS-24V/0.9	DPS-24V/4.0	MB-MHS	MB-MHS-2	BW-MB	MB-DIF-250	MB-DIF-480	MB-DIF-700	MB-DIF-910	MB-DIM 2	BK-Z-12
	Power supply unit		Magnet-holder		Fastening angle	Diffuser				PWM dimmer	Plug-connector
For machine lighting 											
			<ul style="list-style-type: none"> Adhesive force 3.6 kg (2x) 	<ul style="list-style-type: none"> Adhesive force 9.0 kg (2x) 	<ul style="list-style-type: none"> Stepless adjustment 	<ul style="list-style-type: none"> Simple installation using clamping groove 				<ul style="list-style-type: none"> Pulse width modulation Dimming range 5 to 100% 	<ul style="list-style-type: none"> M12, 4-pin
MB-100-K	■	■	■							■	■
MB-100-K-B3	■	■	■							■	■
MB-N-25x-K-B3	■	■		■	■	■				■	■
MB-N-25x-K	■	■		■	■	■				■	■
MB-N-48x-K-B3	■	■		■	■	■	■			■	■
MB-N-48x-K	■	■		■	■	■	■			■	■
MB-N-70x-K-B3	■	■		■	■		■			■	■
MB-N-70x-K	■	■		■	■		■			■	■
MB-N-91x-K-B3	■	■		■	■			■		■	■
MB-N-91x-K	■	■		■	■			■		■	■
MB-NP-250-K	■	■		■	■					■	■
MB-NP-480-K	■	■		■	■					■	■

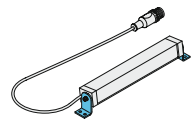
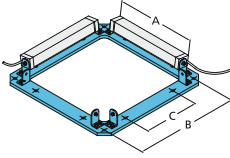
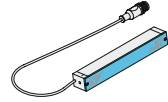
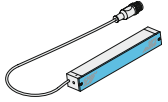
	BW-BE 1-A (2 units)	BE 1-A65-FRAMESET	BE 1-A130-FRAMESET	BE 1-A240-FRAMESET	BE 1-A65-DIF	BE 1-A130-DIF	BE 1-A240-DIF	BE 1-A65-POL	BE 1-A130-POL	BE 1-A240-POL
	Mounting bracket		Mounting frame		Diffuser			Polarizer		
For barlights 										
	<ul style="list-style-type: none"> Stepless adjustment 		<ul style="list-style-type: none"> Stepless adjustment For up to four lights The bracket and fastening materials for four lights are included in the scope of delivery 		<ul style="list-style-type: none"> PMMA Material thickness 3mm 			<ul style="list-style-type: none"> PMMA Material thickness 3mm 		
BE 1-A 65 ...	■	■	■		■			■		
BE 1-A 130 ...	■		■			■			■	
BE 1-A 240 ...	■			■			■			■

BEK-A-MOUNTINGSET		BEK-A100-DIF ¹⁾ (113 mm)	BEK-A300-DIF ²⁾ (313 mm)	BEK-A400-DIF ³⁾ (413 mm)	BEK-A500-DIF ³⁾ (513 mm)	BEK-A100-POL ¹⁾ (113 mm)	BEK-A300-POL ²⁾ (313 mm)	BEK-A400-POL ³⁾ (413 mm)	BEK-A500-POL ³⁾ (513 mm)	BEK-A-NH (2 units)
	Mounting set	Diffuser				Polarizer				Hold-down device set
<p>For barlights</p> <ul style="list-style-type: none"> ◆ Crossbar to cascade two barlights <p>Set consists of: Aluminum crossbars, black, anodized (2 units)</p> <p>Required screws and washers</p>	<ul style="list-style-type: none"> ◆ Homogenous light reduction ◆ Can be retrofitted quickly and easily ◆ Scratch-proof safety screen ◆ Mounting materials included in scope of delivery 	<ul style="list-style-type: none"> ◆ To reduce glare or highlights ◆ Can be retrofitted quickly and easily ◆ Scratch-proof safety screen ◆ Mounting materials included in scope of delivery ◆ High-temperature resistant: For a pulse-break ratio of the lighting, up to 100% 	<ul style="list-style-type: none"> ◆ For holding down attachment panels that have a length of 300 mm or longer <p>Set consists of:</p> <ul style="list-style-type: none"> - Hold-down devices (2x) - Mounting material 							
BEK-A100 ...	■	■				■				
BEK-A300 ...	■		■				■			■
BEK-A400 ...	■			■				■		■
BEK-A500 ...	■				■				■	■
BE-A100 ...	■	■				■				■
BE-A300 ...	■		■				■			■

¹⁾ Delivery does not include a hold-down device set BEK-A-NH

²⁾ Delivery includes a hold-down device set BEK-A-NH

³⁾ Delivery includes two hold-down device sets BEK-A-NH

System holder

Mounting examples system holder, basic holder Ø 12mm

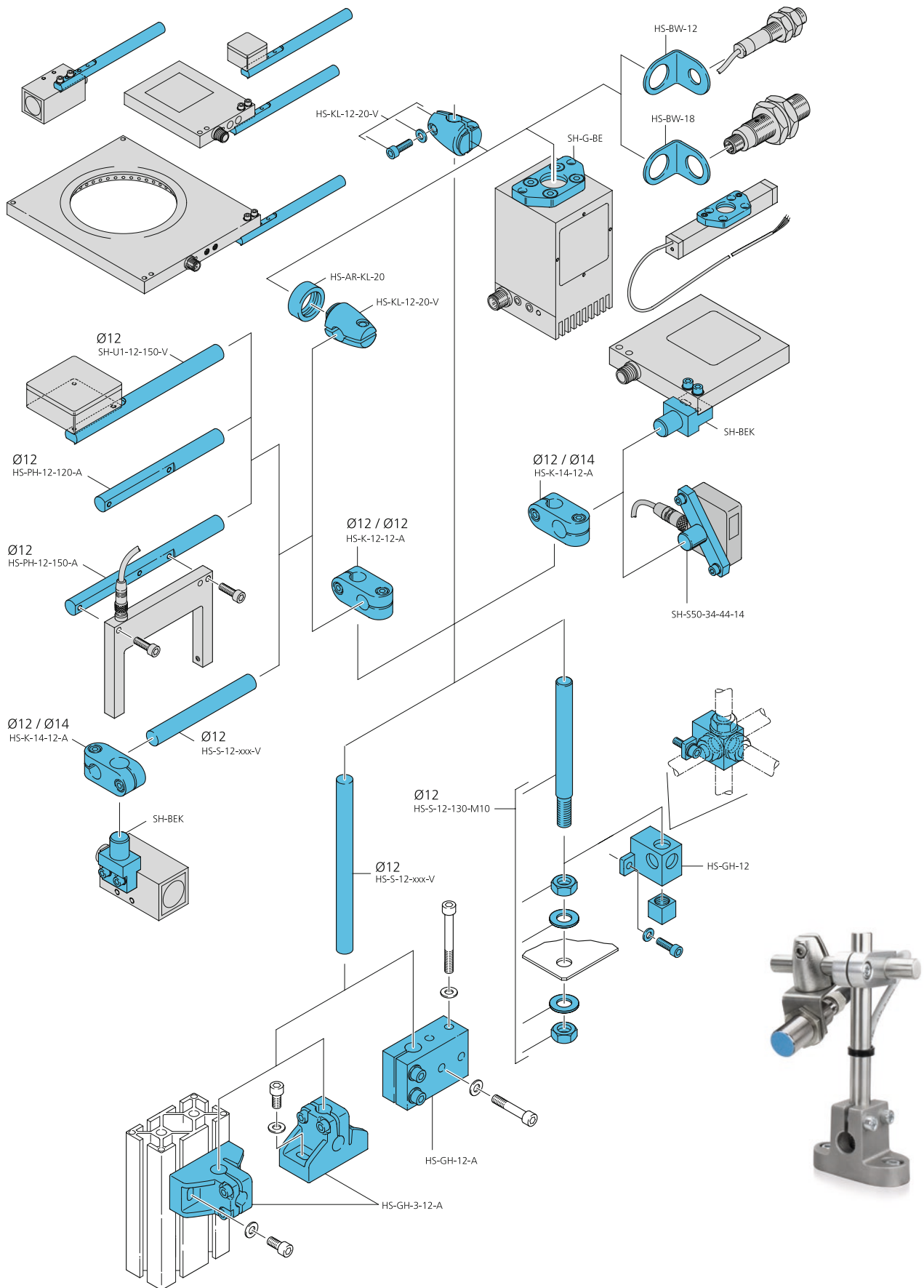

System holder

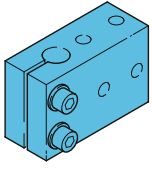
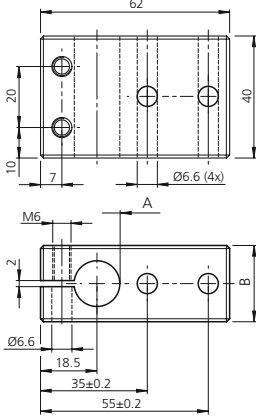
Basic holder		A	B	Aluminum
		12	20	HS-GH-12-A
		15	25	HS-GH-15-A

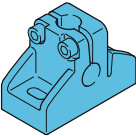
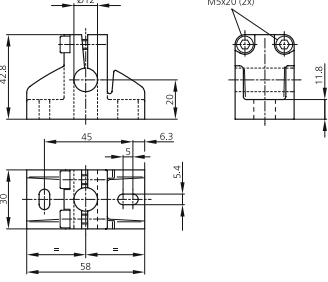
Basic holder			Aluminum
			HS-GH-3-12-A

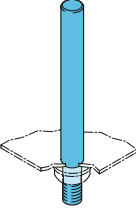
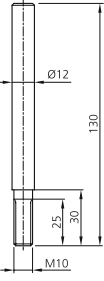
Mounting rod Ø12mm			VA
			HS-S-12-130-M10

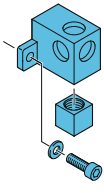
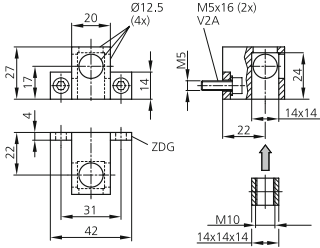
Basic holder for mounting rod HS-S-12-130-M10			ZDG
			HS-GH-12

Cross connector		A	B	C	D	R	Aluminum	
		Ø10	31.5	48	16.5	41.5	HS-K-10-12-A	
		Ø12	31.5	48	16.5	41.5	HS-K-12-12-A	
		Ø14	33.5	50	18.5	43.5	HS-K-14-12-A	
		Ø15	33.5	50	18.5	43.5	HS-K-15-12-A	
Mounting rods Ø12mm		A	B				VA	
		Ø12	100				HS-S-12-100-V	
		Ø12	200				HS-S-12-200-V	
		Ø12	500				HS-S-12-500-V	
Mounting rods Ø15mm		A	B				VA	
		Ø15	100				HS-S-15-100-V	
		Ø15	200				HS-S-15-200-V	
		Ø15	500				HS-S-15-500-V	
Mounting tube Ø15mm		A	B	C			VA	
		Ø15	150	12			HS-R-15-150-V	
Product holder Ø12mm		A	B	C	E		VA	
		Ø12	61	-	120		HS-PH-12-120-V	
		Ø12	61	91	150		HS-PH-12-150-V	

System holder

Clamping cylinder for mounting rods $\varnothing 12$ mm

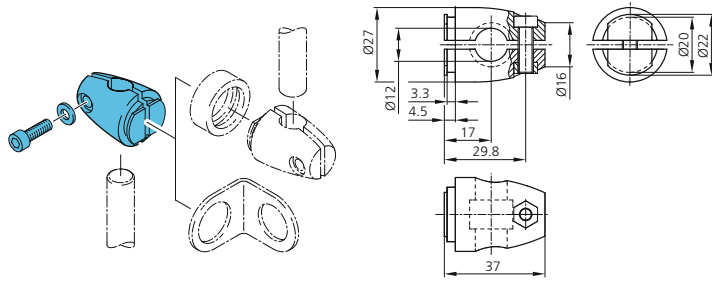

$\varnothing 12.5 / \varnothing 20$

VA

HS-KL-12-20-V

Adapter ring for connecting two clamping cylinders



$\varnothing 20 / \varnothing 20$

VA

HS-AR-KL-20

Mounting bracket

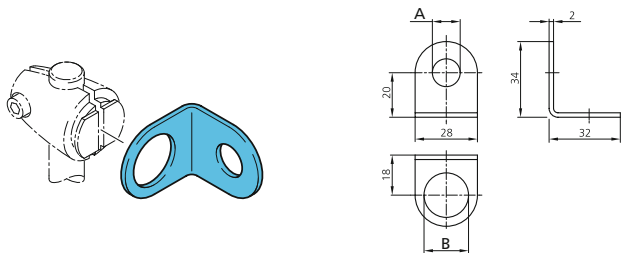

A

B

VA

$\varnothing 12.5$

$\varnothing 20$

HS-BW-12

$\varnothing 18.5$

$\varnothing 20$

HS-BW-18

Basic holder for barlights and coaxial lights

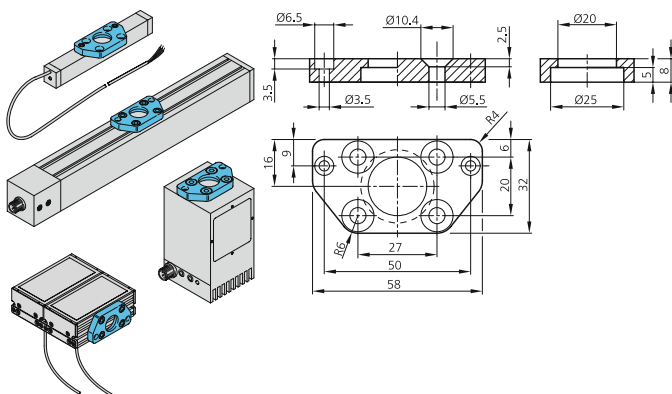

Barlights

BE 1-A 65 ...

BE 1-A 130 ...

BE 1-A 240 ...

BEK-A 100 ...

BEK-A 300 ...

BE-A 130 ...

BE-A 100 ...

BE-A 300 ...

Coaxial lights

BEK-K50/50 ...

Aluminum

SH-G-BE

Adapter plate for mounting a high-power attachment light BEK-R33 on CS 50 Vision Sensor **VA**

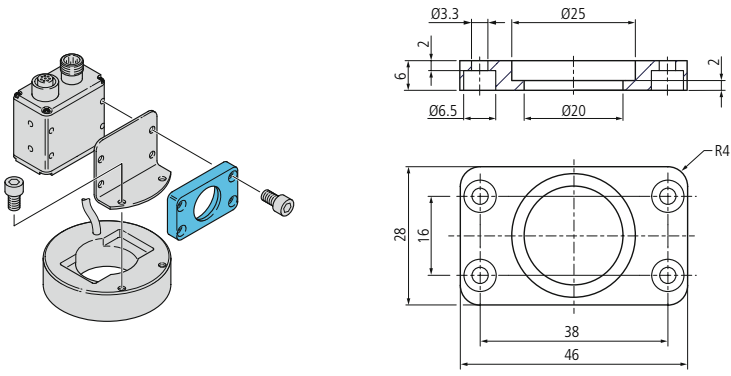

SH-G-CSR

Fastening bracket for CS 50 Vision Sensor **VA**

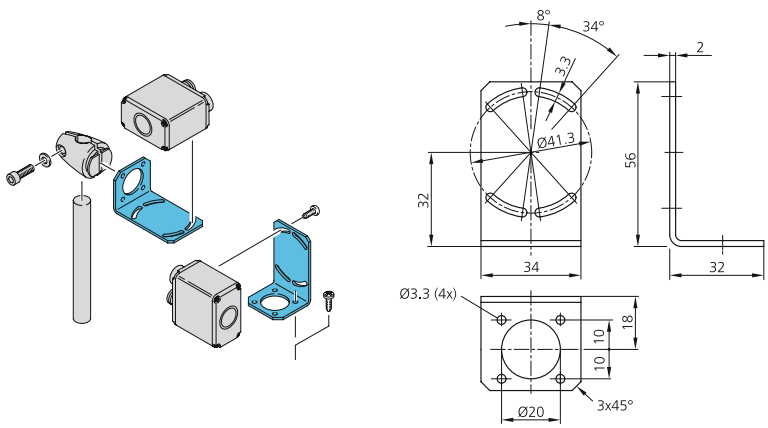

HS-BW-CS

Ball head holder, adjustable for CS 50 Vision Sensor **Aluminum**

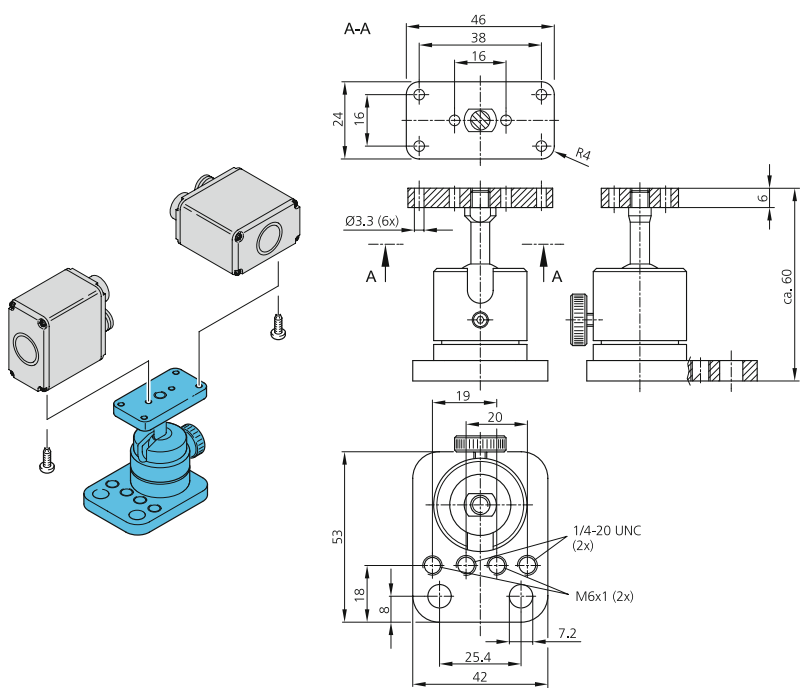

SH-KK-CS

System holder

Mounting plate for CS 50 Vision Sensor

Aluminum

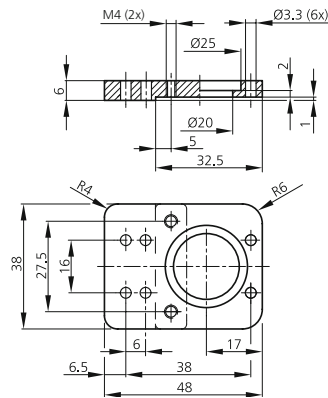
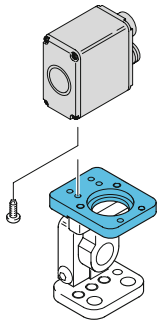

SH-G-CS

Adjustable bracket for mounting plate SH-G-CS

Aluminum

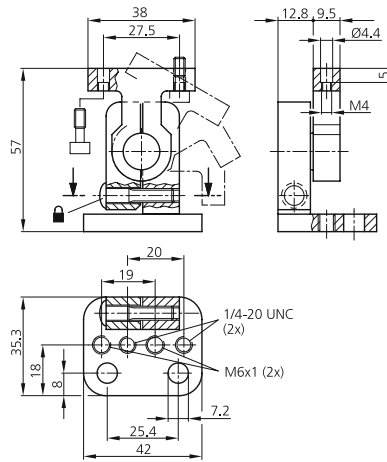
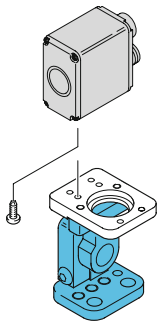

CKR-200-BKT

Holder for cylindrical housing designs

Polyamide

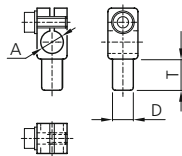
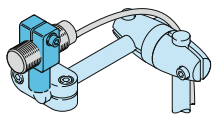

A	D	T	Polyamide
6.5	10	16	SH-6.5-10
8	10	16	SH-8-10
12	10	16	SH-12-10

Universal holder for lights		VA	
	Area lighting	BE-F30/30RL... BE-F50/50RL... BEK-F50/50... BEK-F100/100... BEK-F150/150... BEK-F200/200...	
	Barlights	BE-A 30/30... BE-A 50/50...	
	Spotlights	BEK 1-P xxx...	
	Darkfield lights	BEK-D 70... BEK 1-D 120...	
			SH-U1-12-150-V

Holder for area lights, spotlights and dark field lights		Aluminum
	Area lighting	BEK 1 F...
	Spotlights	BEK 1-P...
	Darkfield lights	BEK-D 70... BEK 1-D 120...
		SH-BEK

Holders for forked and angled light barriers		Plastic	
	For angled light barriers	OGL...-TSSL OGLP...-TSSL	
	For fork light barriers	Fork width of up to 100 mm	
	For fork light barriers	Fork width of 100mm or greater	
		SH-UGU-08-14	
		SH-UGU-20-14	

Holder for light barriers in the 50 housing series		Plastic
		SH-S50-34-44-14

SOLUTIONS. CLEVER. PRACTICAL.

**di-soric
GmbH & Co. KG**

Steinbeisstrasse 6
73660 Urbach
Germany

Phone: +49 71 81 98 79-0

Fax: +49 71 81 98 79-179

info@di-soric.com

www.di-soric.com

**di-soric Solutions
GmbH & Co. KG**

Steinbeisstrasse 6
73660 Urbach
Germany

Phone: +49 71 81 98 78-0

Fax: +49 71 81 98 78-177

solutions@di-soric.com

www.di-soric-solutions.com

**di-soric
International**

di-soric GmbH & Co. KG | Germany

di-soric Solutions GmbH & Co. KG | Germany

di-soric Austria GmbH & Co. KG | Austria

di-soric SAS | France

di-soric SNT AG | Switzerland

di-soric Pte. Ltd. | Singapore

www.di-soric.com/international